



PRODUCT CATALOG
2023 | 2024



EQUIPMENT
FOR TEST AND DIESEL
REPAIR FUEL EQUIPMENT

Test benches, specialized tools, repair complexes, equipment,
electronic devices for CR, UIS, UPS, injection pump systems

www.dieselland.eu

26.02.24

CONTENT

1

Stands and equipment for testing common rail injectors and pumps

TRIUMF – test bench for testing 1-4 CR injectors.....	8
CRUIS – Test bench for testing CR injectors.....	22
CR-Test 4E – test bench for testing pumps and 1-4 CR injectors.....	37
CR-Test-2P – Stand for testing high pressure fuel pumps Common Rail system.....	56
Additional equipment and accessories for stands.....	65
Modernization kit for CR-Jet-4E stands.....	69
PUMP TEST.02 – common-Rail High Pressure Pump Testing Equipment.....	70
CR TESTER . CRT-5040 – a device for testing 1-4 CR injectors.....	71
FLAGMAN-FLOW – 8-channel injector dosage measuring unit.....	72
FLAGMAN-FULL – equipment for testing 1-4 CR injectors without coding.....	72
FLAGMAN-CODE – equipment for testing 1-4 CR injectors with coding.....	73
FLAGMAN-CODE-L – equipment for testing 1-4 CR injectors with coding.....	74
CR-Active – injector signal activator CR.....	75
CR-NeXT – Armature activator device for Common Rail injector solenoid valve.....	75
MONICA – Common Rail injector electromagnet actuation current measuring device.....	75
PTC-2520 CP TESTER – injection pump tester CR.....	75
FMDE-520 – instrument for checking the performance of injection pump CR.....	75
CRistina-PIEZO – PIEZO injector tester CR.....	76
CRISTINA – complex for assembly and adjustment of CR injectors.....	76
PR-TESTER.V05 – electronic pressure gauge 2-channel.....	77
Basic kits for testing CR injectors.....	79
Sets of flasks and adapters for backflow of CR injectors.....	85
Backflow fitting kits for CR injectors.....	86
Universal adapter for truck injectors CR DL-CR50013	94
Adapter for cargo injectors CR Denso to connect the supply and backflow.....	98
Truck injector test adapters.....	99
Equipment for testing pumps and nozzles.....	106
Retrofit kit for 2400 bar CR-Jet stands.....	135

2

Equipment and tools for repairing common rail injectors

CRISTINA – complex for assembly and adjustment of CR injectors.....	136
CRISTINA «BASE» set	137
CRISTINA «BASE-F» set	138
CRISTINA «FULL» set	139
CRISTINA «PROF» set	140

CRISTINA «PROF FULL» set	142
CRISTINA «SPECIAL» set	144
Table stand for tripod CR-CRistina.....	147
Open-end spanner set.....	147
Pneumatic press.....	148
CR injector repair kits.....	149
Set of probes and adapters.....	151
Set of goniometers to control the tightening of the atomizer nut.....	152
Clamp for dismantling and assembling CR injectors.....	153
Adapter kits with digital indicators for measuring mounting clearances and stroke of the spray gun and valve.....	158
CRistina-PIEZO – PIEZO injector tester CR.....	162
CR Siemens VDO injector repair kits.....	163
Hand presses.....	176
MP-250 SASH – CR injector multiplier valve seat restoration machine.....	178
Lapping.....	179
Diamond pastes, lapping plates, a set of washer holders for grinding them.....	182
Tom-2 – Grinding machine for dressing of the laps.....	183
Tom-5 – Grinding machine for dressing of the laps and other bodies of revolution.....	185
BOSCH PIEZO injector recovery kit.....	187
DL-GR7500 – Grinding machine for the needles of nozzles.....	190
DL-GR7400 – Grinding machine for nozzle needles with rotation speed indicators in percent.....	191
DL-GR7300 – Grinding machine for the needles of nozzles with speed indicators.....	192
Sets with an industrial microscope, an extended stand, a backlight and a monitor.....	193
Abrasive stones for GR machines.....	199
Diamond pencils, stone holder, stone balancing axis.....	201
Balancing fixture, stone remover, drive pulley kit.....	202
Additional equipment and accessories for grinding machines.....	203
GM-08 – surface grinder with lower movable work table.....	206
MGM-500 – sliding column surface grinder.....	208
Universal clamping tools for CR and CR Denso injectors.....	209
Nozzle holder blocks CR for vise.....	210
Wrenches for disassembling / assembling injectors.....	211
Bit wrenches for mounting / dismantling the nozzle nut of CR injectors.....	213
Nozzle wrenches for mounting / dismantling the collar nut of the CR injector injectors.....	214
Nozzle wrenches for mounting / dismantling the atomizer nut for BOSCH, VDO (Siemens) and BOSCH series 111 piezo injectors.....	215
Nozzle wrenches for mounting / dismantling the nut of the spray nozzle CR BOSCH, VDO (Siemens), DENSO, DELPHI all types.....	216
Hexagonal wrenches with a square hole for a torque handle.....	218
Keys for disassembly / assembly of the CR SCANIA injector.....	219
Nozzle wrenches for mounting / dismantling the nut of the Delphi Smart Ø20.9mm, Bosch Ø25.8mm injector nozzles. Tools for installing / removing the CRIN injector valve.....	220
CR injector support ring removal and installation kit.....	221

Set of tools for installing the paronite ring of CRIN injectors.....	221
DENSO CR injector filter removal and installation kit.....	222
Sets of cutters for cleaning the seats of the engine injectors Delphi, Bosch.....	223
Torque wrenches, adapters.....	224
Pullers for extracting CR injectors.....	225
Compressor kit for diesel engines.....	227
Kits for measuring compression in diesel engines.....	227
Set for measuring fuel pressure in the low pressure line in diesel and gasoline engines.....	227
Mechanical measuring heads.....	228
Indicator measuring heads.....	229
Racks magnetic for installation of an indicator measuring head.....	234
Digital caliper. Digital micrometer.....	235

3

Auxiliary equipment and tools for checking and repairing dta

Special table-workbench CR-NEXT-ST01	236
Bathtubs are corrosion-proof. ultrasonic baths. Small Parts Cleaning Container.....	236
A set of anti-magnetic tweezers. High magnification lens. microscopes.....	237
Sets with industrial microscope, tripod, illumination and monitor.....	238
Tripod holders for the microscope.....	246
Control rack for test benches for injectors and injection pumps.....	247
Endoscope camera.....	247
Hand presses.....	248

4

Equipment and tools for testing and repairing common rail pumps

PUMP TEST.02 – equipment for testing injection pump CR.....	250
FMDE-520 – CR injection pump performance tester.....	251
PTC-2520 CP TESTER - a device for testing high pressure fuel pumps CR.....	251
ST-03 – universal cradle for CR pumps.....	252
Flanges for injection pump CR.....	253
Couplings for injection pump CR.....	256
A set of supports for installation on the stand of Denso HP0 pumps.....	259
Equipment for repair of injection pump CR CP4 Bosch.....	259
Set of clamps for assembly of injection pump CP3.....	259
Adapters for pressure measurement in injection pump CR CP-3.....	260
Adapter kit for measuring the pressure of the booster pump CR.....	260
Set of fittings with lock for pump test CP1.....	260
Additional equipment for adapter DL-CR31497.....	261
Fittings for connecting high-pressure fuel pumps. Liquid filters.....	262

5

Stands and equipment
for testing unit injectors (UIS) and pump sections (UPS)

DORPAT Multi-Cam11 – stand for testing unit injectors, pump sections.....	263
Additional equipment for DORPAT Multi-Cam11	270
CAM-BOX1 FORCE – basic kit for testing unit injectors and single pumps (UI / UP SYSTEM).....	277
Additional equipment for CAM-BOX 1.....	280
CAM-BOX 2 MASTER – test kit for unit injectors and single pumps.....	282
Additional equipment for CAM-BOX 2.....	285
CAMBAT-FLOW – injection meter of pump-injectors of pumping sections of the UIS/UPS system (for UIS-Tester MULTICAM).....	293
CAMBAT-FULL-SET – equipment for testing and checking the unit injector of pump sections of the UIS / UPS system with a mechanical part.....	295

6

Equipment and tools
for the repair of unit injectors (UIS) and pump sections (UPS)

DL-ST02 – clamp for dismantling and assembling the unit injector of CR injectors.....	296
Keys for positioning the electromagnet in unit injectors.....	300
Keys for mounting / dismantling the nut of the electromagnet of the pump injector valve.....	301
Keys for mounting / dismantling the spray nut of the unit injectors.....	303
Caterpillar injector holder adapter.....	303
Kit for measuring the stroke of the unit injector valve.....	304
Stand adapter for indicator.....	304
Set of keys for disassembly and assembly of AUDI/VW pump injectors.....	305
Tool kit for disassembly-assembly NF Audi / VW Siemens VDO.....	306
Tool kit for disassembly-assembly NF AUDI / VW 1.9 PDE-P1.5.....	307
Tool kit for disassembly-assembly NF AUDI / VW 2.0.....	308
Adapters for testing the injector part of unit injectors.....	309
Adapters for CATERPILLAR.....	312
Adapter kits for testing the injector part.....	314
Hand presses.....	315
A set of diamond laps and reamers for restoring the valve seat.....	317
BOSCH injector pump.....	317
Injector pump valve for VOLVO, SCANIA, IVECO.....	317
Sets of diamond laps and reamers.....	318

7

Equipment and tools
for testing and repairing heui unit injectors

Equipment and tools for checking and repairing HEUI unit injectors.....	319
Adapter for testing the injector part of HEUI unit injectors.....	320
O-ring installation kit for HEUI unit injectors.....	320
Wrench for unscrewing the nut of the HEUI unit injector sprayer.....	320

8

Stands for testing fuel pumps
high pressure injection pump

SPF-708,SPF-712,SPF-1108,SPF-1112,SPF-1508,SPF-1512 - assay stands for injection pumps.....	321
PTB-3, PTB-5, PTB-7, PTB-9, PTB-12 –	323
high-power assay stands for high-pressure fuel pumps	323
PTB14 – assay stand with a capacity of 45 kW for injection pump.....	324
Additional equipment and accessories for stands for testing high-pressure fuel pumps.....	326

9

Equipment and tools
for repair of high pressure fuel pumps

Compensation clutches. Couplings are flanged. Couplings are conical. Spline couplings.....	328
Equipment and tooling for rotary injection pumps and in-line injection pumps.....	329
Devices for adjusting in-line injection pumps.....	332
Couplings for fastening to the pump flange for high-pressure fuel pumps of the VP series.....	333
ST-03 – universal cradle for CR pumps.....	334

10

Electronic devices for diagnostics
and repair of diesel fuel equipment

CR TESTER CRT-5040 – device for testing 1-4 CR injectors.....	335
FLAGMAN FULL – equipment for testing 1-4 CR injectors without coding.....	336
FLAGMAN-FLOW –injector dosage measuring unit 8-channel.....	336
FLAGMAN-CODE – equipment for testing 1-4 CR injectors with coding.....	337
FLAGMAN-CODE-L – equipment for testing 1-4 CR injectors with coding.....	338
CRISTINA – complex for assembly and adjustment of CR injectors.....	339
DL-UNI20150 CRISTINA - PIEZO – PIEZO injector tester CR.....	340
DL-UNI20150A CRISTINA - PIEZO ACOUSTIC – PIEZO injector tester CR.....	341
DL-UNI20050 CRISTINA - PIEZO – set for check and regul. PIEZO-CR injectors.....	342
DL-UNI20050F CRISTINA - PIEZO – set for check and regul. PIEZO-CR injectors.....	343
DL-UNI20050A CRISTINA - PIEZO ACOUSTIC – kit for checking and adjusting PIEZO injectors CR.....	344
DL-UNI20050FA CRISTINA - PIEZO ACOUSTIC – kit for checking and adjusting PIEZO i injectors CR.....	345
DL-UNI20051 set for checking and adjusting PIEZO injectors CR without clamp.....	346
DL-UNI20051A set for checking and adjusting PIEZO injectors CR without clamp.....	347
Additional equipment for CRISTINA-PIEZO.....	348
CR-NeXT – Armature activator device for Common-Rail injector solenoid valve.....	353
Device for measuring the capacitance of piezo-packet injectors RLC.....	354
PUMP TEST.02 – equipment for testing injection pump CR.....	355
FMDE-520 – instrument for checking the performance of injection pump CR.....	356
PTC-2520 CP TESTER – injection pump tester CR.....	356
UIS-TESTER Multi-CAM – device for testing unit injectors and pump sections.....	357

PR- INDICATOR – electronic pressure gauges.....	358
PR-TESTER.V05 – 2-channel pressure measuring device.....	359
PR-TESTER.V03 – a device for measuring pressure. Oscilloscope attachment.....	361
CR test kits.....	362

11

Control and measuring tool and Instrumentation

Pressure gauges and accessories.....	364
Dial-type mechanical measuring heads.....	369
Indicator measuring heads.....	370
Racks magnetic for installation of an indicator measuring head.....	375
Digital caliper. Digital micrometer.....	376
Stand for digital micrometer.....	376
Compression measurement kits in diesel engines.....	377
Set for measuring fuel pressure in the low pressure line in diesel and gasoline engines.....	377
Torque wrenches, adapters.....	378
Hand presses.....	379
Set of goniometers to control the tightening of the atomizer nut.....	381

12

Filters and consumables for test stands for Diesel Fuel Equipment

Liquid fine filters.....	382
Filters - settlers. Liquid filters. Mesh 15 µm for filters.....	383
High pressure filter adapter DL-UNF21100.....	385
High pressure filter for pressure accumulators (Rail).....	385
Adapter with high pressure Bosch filter.....	385
Calibration fluid SRS.....	386
Supplied complete with power supply.....	387
Fittings for connecting hydraulic and pneumatic systems.....	388

13

Spare parts for repair Diesel Fuel Equipment and other equipment

Adjusting washers for Common-Rail injectors BOSCH.....	392
Adjusting washers for CR DENSO injectors.....	397
Adjusting washers for Common-Rail VDO (SIEMENS) PIEZO injectors.....	398
Adjusting washers and adjusting elements for Common-Rail injectors DELPHI.....	399
Adjusting washers for Unit Injectors (UIS) and Single Pumps (PLD).....	400
Tools and fixtures for grinding washers and other parts.....	402

14

Control boards for Dieselland equipment

Control boards for Dieselland equipment.....	403
----------------------------------------------	-----

TRIUMF

TRIUMF benches are manufactured with the possibility of retrofitting with a hardware and software complex for encoding Bosch, Delphi, Denso injectors. To encode the Delphi injectors, a device is additionally installed, which allows to create a vacuum in the backleak line of the injector. The set of the vacuum creating device is a gear pump, a venturi tube and an electric motor. The device is installed on the bulkhead, which is located in the lower part of the bench above the cooling unit.

- The software allows you to code injectors BOSCH isa / ima cod, Delphi C2i / C3i / C4i*, Denso, VDO Siemens.
- Working pressure up to 1800 bar. It is possible to increase the working pressure to 2400 bar.
- The stand is produced with the following characteristics of the main drive:
 - TRIUMF 4 kW 380 V
 - TRIUMF 5,5 kW 380 V

* coding Delphi C4i in the stand TRIUMF 5,5 kW 380 V



TRIUMF

Software «CASCADE»



The software has a user-friendly interface. The program contains built-in test plans for testing and coding Bosch, Delphi, Denso, Siemens (VDO) injectors. Functions for creating new test plans, editing built-in ones, as well as creating targets for Delphi C2i, C3i, C4i injectors are available. The results and progress of testing are displayed in graphical form and saved to a file and sent to print.

The stand is equipped with a modern system of thermal stabilization test liquids in the tank, which includes:

1. Two radiators with forced air cooling for the backflow line from the injection pump and the backflow line from the pressure accumulator (rail).
2. Pressure accumulator with cooling. The rail cooling line includes an individual air-cooled radiator and a circulation pump.
3. Independent refrigeration unit with air heat exchanger.
4. Three individual thermal controllers for controlling radiator fans.
5. Tubular electric heater with a power of 1000 W for heating the test liquid in the tank.

- Operating pressure up to 2400 bar.
- The pressure is controlled by two regulators.
- The stand has an electronic measurement system with the ability to check four injectors at the same time.
- The stand is equipped with a frequency converter.

TRIUMF

STAND EQUIPMENT

**DL-CAU001**

Cable for BOSCH injectors (universal)

**DL-CAU002**

Cable for Delphi injectors (C2i, C3i)

**DL-CAU003**

Delphi injector cable (C3i)

**DL-CAU004**

Cable for injectors BOSCH, SIEMENS

**DL-CAU005**

Cable for BOSCH injectors

**DL-CAU007**

Cable for cargo injectors

**DL-CAU006**

Universal cargo injector cable

**DL-CAU09**

Pressure sensor cable

**DL-CAU10**

Pressure regulator connection cable

TRIUMF

STAND EQUIPMENT



DL-24CRM

Set of fittings for reverse draining CR injectors



DL-UNI50343

Nozzles for sprayers
nozzles Ø= 9 mm (1 pc.)



DL-UNI50083

Adapter straight with M14
on M12 for tube (4 pcs.)



DL-CR10015

Nozzle holder frame with
cups (**DL-UNI50342**) for sprayers 7 mm (4 pcs.)
and clamping sleeves

- DL-UNI31019 Ø=17 (4pcs.)
- DL-UNI31020 Ø=18,9 (1pc.)
- DL-UNI31021 Ø=19,2 (1pc.)
- DL-UNI31022 Ø=21 (1pc.)
- DL-UNI31231 Ø=21,4 (1pc.)



D-OCDE

Reverse set
drain nozzle
Denso (4 pcs.)



DL-54127

Leg (foot with
regulating
bolt) (4 pcs.)



DL-CR50162

Stubs on RAIL
(4 pcs.)



DL-UNI30497

Stub instead
regulator
pressure (1 pc.)



DL-TVD41414

High pressure pipes
M14xM14x400mm (4 pcs.)



Door key
(4 pcs.)

TRIUMF

OPTIONAL EQUIPMENT AND ACCESSORIES

**DL-MOK**

Coupling adapter with check valve
Ø 6 x Ø 6mm with collet

**DL-CR50120**

Valve for respons time (DELPHI)

**DL-CR50136**

Check valve
BOSCH electromagnetic injectors on the stand

**DL-CR50210**

Return pressure valve for testing piezo injectors
SIEMENS at the booth

**DL-CR50177**

Return pressure valve for
Bosch piezo injectors



TRIUMF

OPTIONAL EQUIPMENT AND ACCESSORIES

**DL-CR50013**

Universal adapter for cargo injectors CR (Bosch, Denso, Delphi Smart) for supply connection and back drain with approach angles 0°, 4° and 13°.



**DL-CR50140**

Universal adapter for trucks injectors CR Denso, including Volvo 21952974 for supply and return connection.

TRIUMF

OPTIONAL EQUIPMENT AND ACCESSORIES

ADAPTERS FOR TESTING CARGO INJECTORS

					
DL-02 DL-CR31046	DL-04A DL-CR30848	DL-05N DL-CR31048	DL-06 DL-CR31440	DL-07 DL-CR31044	DL-08 DL-CR31045
BOSCH MAN Ø 29MM	BOSCH RENAULT Ø 32MM	CUMMINS	DENSO Ø 27MM	DENSO Ø 23,5MM	BOSCH MAN Ø 26MM
					
DL-09 DL-CR31439	DL-010 DL-CR31047	DL-011 DL-CR30985	DL-012 DL-CR30036	DL-013 DL-CR30968	DL-014 DL-UNI30038
BOSCH VOLVO Ø 28MM	CUMMINS	SIEMENS VDO FORD	CRIN BOSCH SISU Ø 26,6MM	DELPHI SMART INJECTOR	DENSO
					
DL-015 DL-CR30822	DL-016 DL-CR31486	DL-017 DL-UNI30037	DL-018 DL-CR30595	DL-019 DL-CR30804	DL-020 DL-CR30596
DENSO Ø 18,5 MM Caterpillar, Perkins	SCANIA 2/4 pin	BOSCH DEUTZ Ø 21,5MM	CURSOR 9	BOSCH MTU	SCANIA 4 PIN
					
DL-021 DL-CR31565	DL-022 DL-CR31566	DL-023 DL-CR31567	DL-024 DL-CR31620	DL-025 DL-CR31625	DL-026 DL-CR31626
BOSCH CRIN3 0445124015	Caterpillar 3809888	Delphi Smart injector Mercedes	DAF-SMART injector	DELPHI CRIN DAF EURO 6 SMART INJ	CUMMINS
					
DL-027 DL-CR31698	DL-030 DL-CR30818	DL-031 DL-CR31040	DL-032 DL-CR31430	DL-033 DL-CR31479	DL-034 (CR31538)
BOSCH	BOSCH ЯМ3-530	BOSCH 0445120303	BOSCH 0445120134	DENSO	DENSO 1211 11L1063 (095000-121)
					
DL-035 DL-CR31561	DL-036 DL-CR31563	DL-037 DL-CR50304	DL-038 DL-CR31606		
DENSO	Delphi A9362187 Mercedes Actros Euro 6	MB Actros	5296723 DENSO		

TRIUMF

OPTIONAL EQUIPMENT AND ACCESSORIES

DL-UNF20420L

A set of sedimentation filters for testing injectors on the stand TRIUMPH.
Designed for preliminary cleaning of nozzles before their bench test.



Комплект поставки:

1. **DL-UNF20300L** Settling filter (inlet on the left) - 2 pcs.
2. **DL-UNI31427** Adapter 1/8"xM14x1.5mm – 4 pcs.
3. **34-RL010602** Quick adapter straight \varnothing 6x1/4" – 2 pcs.
4. **34-RL310602** Quick adapter angled \varnothing 6x1/4" – 2 pcs.
5. **DL-UNI31399** Splitter 1/4" – 1 pc.

Attention!
All items are also sold separately.

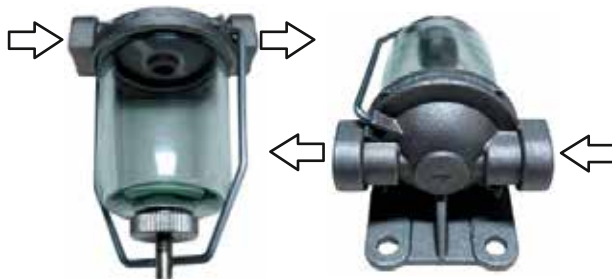

DL-UNF20420L

Filter - sump (entrance on the left)
The filter contains:

1. Holes for entry and exit M14x1.5mm
2. Mounting holes \varnothing 8mm



DL-UNI31399

Splitter 1/4"
Attached to the splitter:

1. **34-RL010802** Two quick adapters \varnothing 8mm (at ends)
2. **34-RL310601** Two corner fast adapter \varnothing 6mm (at the ends)

TRIUMF

OPTIONAL EQUIPMENT AND ACCESSORIES

DL-UNI01792

A set of open-end wrenches for the TRIUMF stand has a convenient and secure fixation of keys directly in the test bench.

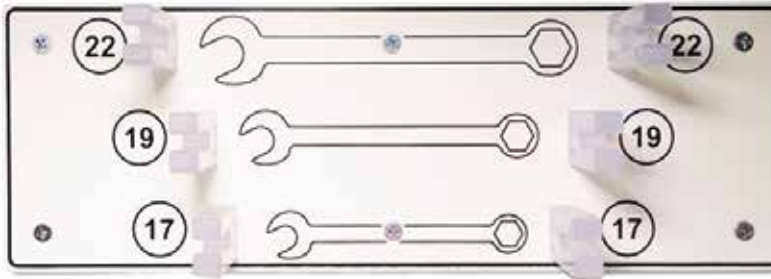

Contents of delivery:

1. **DL-TRF50244** Key holder
2. **DL-UNI31217** Open-end wrench 17x17mm -1 pc
3. **DL-UNI31219** Open-end key. 19x19mm -1 pc.
4. **DL-UNI31222** Open-end key. 22x22mm -1 pc.

Attention!
All keys are also sold separately.

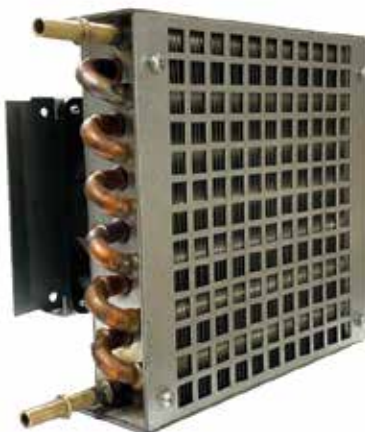

DL-ORV6

**Air defense radiator for
pressure accumulator stands TRIUMF**

TRIUMF

OPTIONAL EQUIPMENT AND ACCESSORIES

DL-HEUI0037

TRIUMF Low Pressure Equipment 0-8 bar for HEUI injector checks

24-DBK-06L	Three-way valve 3/8"	1 pc.
26-04020-06	Connecting sleeve 3/8".	1 pc.
13-VMP-06	Safety valve (SV) 3/8"	1 pc.
DL-UNI20024	SV mounting bracket to oil filter with 2 screws M16x16mm	1 pc.
13-VRFB04	Throttle 1/4"	1 pc.
DL-UNI31316	SS washer 50x22mm "OIL SUPPLY" (FUEL SUPPLY)	1 pc.
041616005	Support washer, hole diam. 22mm	1 pc.
DL-UNI30020	Union 1/4"x8mm (discharge to tank from SV)	1 pc.
DL-UNI30859	Union 3/8"x8mm (discharge from SV to tank)	1 pc.
DL-UNI30530	Union 3/8"x3/8" (three-way valve: 2 pc. SV: 1 pc.)	3 pcs.
DL-UNI30363	Banjo bolt 3/8"	2 pcs.
DL-UNI30365	Banjo bolt 1/4"	1 pc.
12-03-005	Banjo female, diam. 14mm (1/4")	1 pc.
34-MA16-08-14	Quick adapter, elbow, 8mm x 1/4"	2 pcs.
DL-UNI31036	Special union 3/8"x3/8"x1/8" for supply.	1 pc.
DL-UNI31024	Special union 3/8"x3/8"x for leak-off	1 pc.
A50051-06-06	Elbow union 3/8"x8mm for special unions.	2 pcs.
DL-UNI20016	Pressure gauge bracket	1 pc.
12-TG63-010	Flanged pressure gauge 0-10 bar	1 pc.
DL-UNI30613	Pressure gauge sleeve 1/4"x 1/8"	1 pc.
34-MA12-04-18	Quick adapter, diam. 4mm x 1/8"	1 pc.
34-PTFE-04-250	PVC tube 4mm x 250mm for pressure gauge	1 pc.

TRIUMF

OPTIONAL EQUIPMENT AND ACCESSORIES

P1331012019-850	PVC tube 8mm x 850mm for drain from throttle to tank	1 pc.
TI-1ZTX-06-090	High-pressure fuel line 3/8"x 3/8" L=90 cm	1 pc.
18-806-008-173	Low-pressure fuel line (LPFL) 8mm L=173cm (SV-Spec. union. "Oil Supply").	1 pc.
18-806-008-155	LPFL 8mm L=155cm (Throttle-Special union "Oil Return")	1 pc.
18-806-008-105	LPFL inside diam. 8mm L=105cm (SV-tank)	1 pc.
DL-UNI20021	Washer with marking "FUEL SUPPLY"	1 pc.
DL-UNI20022	Washer with marking "FUEL RETURN"	1 pc.
0540159	Clamps 15mm	8 pcs.
004636	Screw M3x6mm for pressure gauge mounting	3 pcs.
0046435	Screw M4x35mm	6 pcs.
0083645	Screw M6x45mm+washer+nut for SV mounting	2 set
D-GM1504AN	Rubber-metal washer 1/4" for banjo bolt on throttle	2 pcs.
D-GM1506AN	Rubber-metal washer 3/8" for three-way valve	4 pcs.

ATTENTION! The three low-pressure fuel lines (LPFL, items 25, 26 and 27) can be supplied as a single 433cm LPFL

TRIUMF

OPTIONAL EQUIPMENT AND ACCESSORIES

DL-HEUI0037

Equipment for 0-8 bar low pressure generation for checking of HEUI unit injectors using the test bench TRIUMF



TRIUMF

OPTIONAL EQUIPMENT AND ACCESSORIES

DL-HEUI0037

Equipment for 0-8 bar low pressure generation for checking of HEUI unit injectors using the test bench TRIUMF



TRIUMF

OPTIONAL EQUIPMENT AND ACCESSORIES

HEUI INJECTOR TESTING TOOL

HEUI CATERPILLAR 3126B,
CATERPILLAR 3126E и FORD 1998-2003
DIESEL 7.3 FUEL INJECTOR 128-6601,
AD1831489C1 (INTERNATIONAL)



Equipment includes:

1. **DL-HEUI50223** Pump installation adapter nozzles



2. **DL-HEUI50240** Set of hydraulic hoses and HP line 400mm 14x14mm
3. **DL-HEUI50219** Adapter holder with clamping strip.
4. **DL-HEUI50230** Adapter cable for connecting the unit injector
5. **DL-UNI50084** Angular adapter M14.



Attention! All accessories are sold separately.

HEUI CATERPILLAR C7-C9



Equipment includes:

1. **DL-HEUI50221** Pump installation adapter nozzles



CRUIS

The **CRUIS** stand allows you to perform procedures related to testing and checking Common-Rail injectors from manufacturers such as Bosch, Denso, Delphi, VDO (Siemens), Cummins, AZPI, as well as HEUI Caterpillar unit injectors installed on diesel engines of light and medium-sized automobiles, including high-speed engines of cars and trucks, buses, agricultural machinery and tractors.

- The software allows coding BOSCH isa / ima cod, Delphi C2i / C3i / C4i*, Denso, VDO Siemens injectors.
- Stand working pressure up to 2400 bar.
- The stand is produced with the following characteristics of the main drive:
 - CRUIS 4 kW 380 V,
 - CRUIS 5.5 kW 380 V,
 - CRUIS 4 kW 220 V

* Delphi C4i coding in CRUIS 5.5 kW 380 V

When installing additional equipment, the CASCADE program allows you to test HEUI unit injectors.



CRUIS

Software «CASCADE»

**The stand has a low noise level.**

When starting the high-pressure pump, its smooth spin-up is ensured due to the use of a Schneider frequency converter in the stand.

The design of the CR test stand and the elements of its equipment meet the requirements of international standards in terms of static and dynamic parameters of ISO 4008/1 and ISO 4008/2.

For coding Delphi injectors, a device is used that allows creating a vacuum in the injector backflow line. The set of the device that creates a vacuum includes a gear pump, a venturi tube and an electric motor. The device is installed at the bottom of the stand next to the refrigeration unit. Also, in the working (test) area at the top right, a pressure gauge is installed that measures the vacuum with an electrovalve providing vacuum access to the nozzle. In this case, the vacuum is regulated by a throttle valve installed under the monitor on the left. When coding Delphi injectors in the CRUIS stand, a sensor is used that determines the injection start time.

The program with test plans is included in the package. Software updates that include new test plans are released twice a year and are provided free of charge.

For thermal stabilization of the test liquid in the tank, the following are used:

1. two radiators with forced air cooling for the backflow line from the injection pump and the backflow line from the pressure accumulator (rail).
2. independent refrigeration unit with air heat exchanger.
3. tubular electric heater 1000 W

Operating pressure up to 1800 bar. It is possible to increase the working pressure up to 2400 bar.

The stand has an electronic measurement system with the ability to check one nozzle.

CRUIS

STAND EQUIPMENT

**DL-CAU011**

Cable for BOSCH injectors (universal)

**DL-CAU012**

Cable for Delphi injectors (C2i, C3i)

**DL-CAU013**

Delphi injector cable (C3i)

**DL-CAU014**

Cable for injectors BOSCH, SIEMENS

**DL-CAU015**

Cable for BOSCH injectors

**DL-CAU016**

Universal cargo injector cable

**DL-CAU017**

Cable for cargo injectors

**DL-CAU09**

Pressure sensor cable

**DL-CAU10**

Pressure regulator connection cable

CRUIS

STAND EQUIPMENT



Set of fittings for reverse drain nozzles CR BOSCH, DENSO, DELPHI, SIEMENS



DL-TVD41414

High pressure tube
M14 x M14 x 400mm (1 pc)



Door key
(4 pcs)



DL-UNI50083

Adapter straight
from M14 to M12 for
tubes (1 pc)



DL-UNI30497

Stub instead
regulator
pressure (1 pc)



DL-CR50162

Plug for
RAIL (1 pc)



DL-UNI31011

Clamping sleeves
Ø17; Ø18,9; Ø19,2;
Ø21 и Ø21,4



DL-UNI50343

Spray nozzle
nozzles Ø=9 mm (1 pc)



DL-54127

Leg (foot with adjustable
bolt) (4 pcs)

OPTIONAL EQUIPMENT AND ACCESSORIES



DL-CR50015

Sensor for coding
Ø=7mm (1 pc)



DL-UNI50273

Handle for convenient
stand movement.
Set includes 2 handles

CRUIS

OPTIONAL EQUIPMENT AND ACCESSORIES

**DL-MOK**

Coupling adapter with check valve
Ø 6 x Ø 6mm with collet

**DL-CR50120**

Valve for response time (DELPHI)

**DL-CR50136**

Check valve
BOSCH electromagnetic injectors on the stand

**DL-CR50210**

Return pressure valve for testing piezo injectors
SIEMENS at the booth

**DL-CR50177**

Return pressure valve for
Bosch piezo injectors



CRUIS

OPTIONAL EQUIPMENT AND ACCESSORIES

**DL-CR50013**

Universal adapter for CR truck injectors (Bosch , Denso, Delphi Smart) for supply and backflow lines at angles of 0°, 4° and 13°. It is used both for testing nozzles on test benches, and when checking the spray part of nozzles on a hand press.





**DL-CR50140**

Adapter for truck injectors CR Denso, including Volvo21952974 for connecting the supply and overflow drain

CRUIS

OPTIONAL EQUIPMENT AND ACCESSORIES

ADAPTERS FOR TESTING CARGO INJECTORS

					
DL-02 DL-CR31046	DL-04A DL-CR30848	DL-05N DL-CR31048	DL-06 DL-CR31440	DL-07 DL-CR31044	DL-08 DL-CR31045
BOSCH MAN Ø 29MM	BOSCH RENAULT Ø 32MM	CUMMINS	DENSO Ø 27MM	DENSO Ø 23,5MM	BOSCH MAN Ø 26MM
					
DL-09 DL-CR31439	DL-010 DL-CR31047	DL-011 DL-CR30985	DL-012 DL-CR30036	DL-013 DL-CR30968	DL-014 DL-UNI30038
BOSCH VOLVO Ø 28MM	CUMMINS	SIEMENS VDO FORD	CRIN BOSCH SISU Ø 26,6MM	DELPHI SMART INJECTOR	DENSO
					
DL-015 DL-CR30822	DL-016 DL-CR31486	DL-017 DL-UNI30037	DL-018 DL-CR30595	DL-019 DL-CR30804	DL-020 DL-CR30596
DENSO Ø 18,5 MM Caterpillar, Perkins	SCANIA 2/4 pin	BOSCH DEUTZ Ø 21,5MM	CURSOR 9	BOSCH MTU	SCANIA 4 PIN
					
DL-021 DL-CR31565	DL-022 DL-CR31566	DL-023 DL-CR31567	DL-024 DL-CR31620	DL-025 DL-CR31625	DL-026 DL-CR31626
BOSCH CRIN3 0445124015	Caterpillar 3809888	Delphi Smart injector Mercedes	DAF-SMART injector	DELPHI CRIN DAF EURO 6 SMART INJ	CUMMINS
					
DL-027 DL-CR31698	DL-030 DL-CR30818	DL-031 DL-CR31040	DL-032 DL-CR31430	DL-033 DL-CR31479	DL-034 (CR31538)
BOSCH	BOSCH ЯМ3-530	BOSCH 0445120303	BOSCH 0445120134	DENSO	DENSO 1211 11L1063 (095000-121)
					
DL-035 DL-CR31561	DL-036 DL-CR31563	DL-037 DL-CR50304	DL-038 DL-CR31606		
DENSO	Delphi A9362187 Mercedes Actros Euro 6	MB Actros	5296723 DENSO		

CRUIS

OPTIONAL EQUIPMENT AND ACCESSORIES

DL-UNF20420R

Set of pit filters for the injector testing on CRUIS test bench

Designed for pre-cleaning the injectors before they are tested on the test bench.

**Contents of delivery:**

1. **DL-UNF20300R** Settling filter (entrance on the right) – 2pc
2. **DL-UNI31427** Adapter 1/8"xM14x1,5mm – 4pc
3. **34-RL010602** Quick adapter straight $\text{\O} 6 \times 1/4"$ – 2pc
4. **34-RL310602** Quick adapter angled $\text{\O} 6 \times 1/4"$ – 2pc
5. **DL-UNI31399** Splitter 1/4" – 1pc

Attention!
All items are also sold separately.

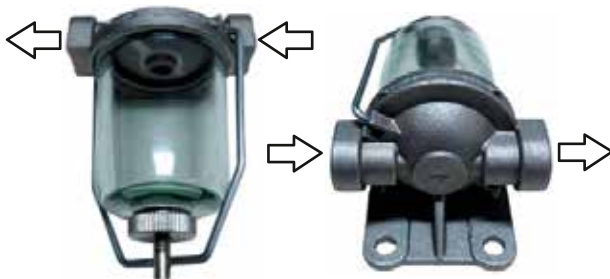
**DL-UNF20300R**

Pit filter (entrance on the right)
The filter contains:

1. Holes for entry and exit M14x1,5mm
2. Mounting holes $\text{\O} 8 \text{mm}$

**DL-UNI31399**

Splitter 1/4"
Attached to the splitter:

1. **34-RL010802** Two quick adapters $\text{\O} 8 \text{mm}$ (at ends)
2. **34-RL310601** Two corner fast adapter $\text{\O} 6 \text{mm}$ (at the ends)

CRUIS

OPTIONAL EQUIPMENT AND ACCESSORIES

DL-UNI01791

Set of open-end spanners for the CRUIS stand.

The set has a convenient and secure fixation of keys directly in the test bench.

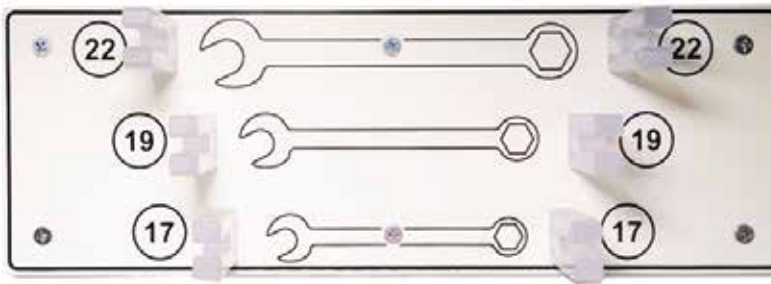
**Contents of delivery:**

1. **DL-CRS50243** Key holder
2. **DL-UNI31217** Open end wrench 17x17mm -1 pc
3. **DL-UNI31219** Open end wrench 19x19mm -1 pc
4. **DL-UNI31222** Open end wrench 22x22mm -1 pc

Attention!
All keys are also sold separately.



DL-ORV3

**Air Defense Radiator for
Cruis Stand Pressure Accumulator**

CRUIS

OPTIONAL EQUIPMENT AND ACCESSORIES

DL-HEUI0038

Equipment for creating low pressure 0-8 bar CRUIS for HEUI injector checks

24-DBK-06L	Crane 3-way 3/8"	1 pc
26-04020-06	Coupling 3/8"	1 pc
13-VMP-06	Safety valve (PC) 3/8"	1 pc
DL-UNI20023	Bracket for fastening the PC to the FTO (filter) bracket	1 pc
13-VRFB04	Choke 1/4"	1 pc
DL-UNI31316	Stainless steel washer 50 x 22mm "OILSUPPLY" (FUELSUPPLY)	1 pc
041616005	Washer persistent Ø otv. 22mm	1 pc
DL-UNI30020	Fitting 1/4 "x 8mm (draining into the tank from the PC)	1 pc
DL-UNI30859	Fitting 3/8" x 8mm (drain from PC to tank)	1 pc
DL-UNI30530	Fitting 3/8" x 3/8" (3-way valve - 2 pcs. PC - 1 pc.)	3 pcs
DL-UNI30363	Bolt Banjo 3/8"	2 pcs
DL-UNI30365	Bolt Banjo 1/4"	1 pc
12-03-005	Banjo fitting "female" Ø 14mm (1/4")	1 pc
34-MA16-08-14	Quick adapter elbow 8mm x1/4"	2 pcs
DL-UNI31036	Specialist. fitting 3/8" x 3/8" x 1/8" for supply	1 pc
DL-UNI31024	Specialist. fitting 3/8" x 3/8" for backflow	1 pc
A50051-06-06	Elbow fitting 3/8" x 8mm for special fittings	2 pcs
DL-UNI20015	pressure gauge bracket	1 pc
12-TG63-010	Flanged manometer 0-10 bar	1 pc
DL-UNI30613	Coupling for pressure gauge 1/4" x 1/8"	1 pc
34-MA12-04-18	Quick adapter Ø 4mm x 1/8"	1 pc
34-PTFE-04-250	PVC tube 4mm x 250mm for pressure gauge	1 pc

CRUIS

OPTIONAL EQUIPMENT AND ACCESSORIES

P1331012019-850	PVC pipe 8mm x 850mm for draining from the throttle into the tank	1 pc
TI-1ZTX-06-015	High pressure fuel line 3/8" x 3/8" L=15cm	1 pc
18-806-008-104	LPT Ø 8mm L=104cm (PC-Special Fitting "OilSupply")	1 pc
18-806-008-075	LPT Ø 8mm L=75cm (Throttle-Special Fitting "OilReturn")	1 pc
18-806-008-037	LPT Ø vnutr.8mm L=37sm (PC-Tank)	1 pc
DL-UNI20021	Washer labeled "FUELSUPPLY"	1 pc
DL-UNI20022	Washer labeled "FUELRETURN"	1 pc
0540159	Clamps 15mm	8 pcs
004636	Screw M3 x 6mm for fixing the pressure gauge	3 pcs
0089416	Screw M4 x 16mm for fastening special fittings	6 pcs
0083645	Screw M6 x 45mm + washer + nut for PC fixing	2 set
D-GM1504AN	Rubber washer. 1/4" for banjo bolts on throttle	2 pcs
D-GM1506AN	Rubber washer. 3/8" for 3-way valve	4 pcs

ATTENTION!

It is allowed to supply low-pressure fuel lines (LPF) in one piece 216 cm long.

CRUIS

OPTIONAL EQUIPMENT AND ACCESSORIES

DL-HEUI0038

CRUIS low pressure tool 0-8 bar for testing pump injector HEUI



CRUIS

OPTIONAL EQUIPMENT AND ACCESSORIES

DL-HEUI0038

CRUIS low pressure tool 0-8 bar for testing pump injector HEUI



CRUIS

OPTIONAL EQUIPMENT AND ACCESSORIES

DL-HEUI0038

CRUIS low pressure tool 0-8 bar for testing pump injector HEUI



CRUIS

OPTIONAL EQUIPMENT AND ACCESSORIES

ACCESSORIES FOR CHECKING HEU INJECTORS

HEUI CATERPILLAR 3126B,
CATERPILLAR 3126E и FORD 1998-2003
DIESEL 7.3 FUEL INJECTOR 128-6601,
AD1831489C1 (INTERNATIONAL)



Equipment includes:

1. **DL-HEUI50223** Pump installation adapter nozzles



2. **DL-HEUI50240** Set of hydraulic hoses and HPT 400mm 14x14mm
3. **DL-HEUI50219** Adapter holder with clamping bar
4. **DL-HEUI50230** Adapter cable for connecting the pump injector
5. **DL-UNI50084** Corner adapter M14



Attention! All accessories are sold separately.

HEUI CATERPILLAR C7-C9



Equipment includes:

1. **DL-HEUI50221** Pump installation adapter nozzles



CR-Test4E

The test bench **CR-Test4E** allows checking the following equipment of the COMMON RAIL system: BOSCH, DENSO, DELPHI nozzles, (SIEMENS optional), BOSCH, DENSO, DELPHI, SIEMENS pumps (CP1, CP2, CP3, HP2, HP3, DFP1, DFP3, DFP6, HP3, HP4), regulators and pressure sensors. The operating pressure of the test is up to 1800 bar. At the request of the customer, there is possibility to increase the working pressure to 2200 bar. Test bench is equipped with an electronic measuring system. Test bench includes a software with built-in test plans.

CR-Test-4E - test stand for Common Rail (CR) injectors and pumps with an electronic measurement system (simultaneous testing of up to 4 injectors); The performance of the CR injection pump is checked using a two-channel flow meter.



CR-Test4E

Software

«CASCADE»

The complex includes software software for testing CR injectors



«DieselTest»

The complex includes software pump testing software



CR-Test4E

Программное обеспечение «CASCADE»



The software has a user-friendly interface. The program contains built-in test plans for testing and coding Bosch, Delphi, Denso, Siemens (VDO) injectors. Functions for creating new test plans, editing built-in ones, as well as creating targets for Delphi C2i, C3i, C4i injectors are available. The results and progress of testing are displayed in graphical form and saved to a file and sent to print.

The stand is equipped with a modern system of thermal stabilization test liquids in the tank, which includes:

1. Two radiators with forced air cooling for the backflow line from the injection pump and the backflow line from the pressure accumulator (rail).
2. Pressure accumulator with cooling. The rail cooling line includes an individual air-cooled radiator and a circulation pump.
3. Independent refrigeration unit with air heat exchanger.
4. Three individual thermal controllers for controlling radiator fans.
5. Tubular electric heater with a power of 1000 W for heating the test liquid in the tank.

- Operating pressure up to 2400 bar.
- The pressure is controlled by two regulators.
- The stand has an electronic measurement system with the ability to check four injectors at the same time.
- Drive motor power for checking high pressure fuel pump - 11 kW
- Drive motor power for checking injectors - 5.5 kW
- The stand is equipped with frequency converters.

CR-Test4E

STAND EQUIPMENT

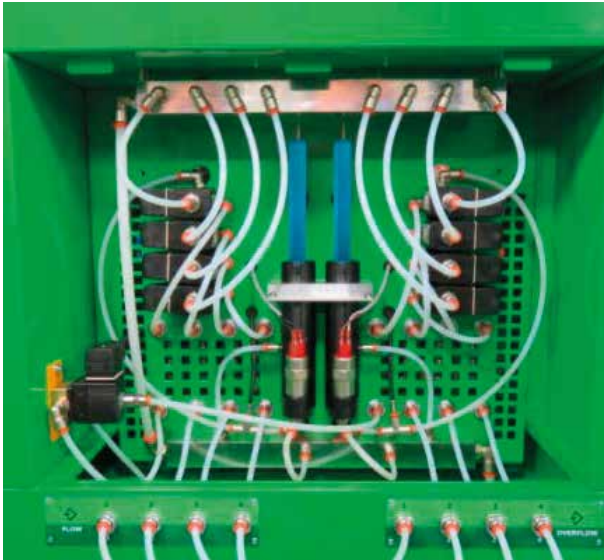

**Liquid flow meter
for simultaneous checking
from 1 to 4 nozzles.**
Installed on a stand.



FMDE-520

**Liquid flow meter
for pumps 2-channel.**
Installed on a stand.



PTC-2520

Pump control controller.
Installed on a stand.



Injector controller.
Installed on a stand.

CR-Test4E

STAND EQUIPMENT



DL-24CRM

Set of fittings for reverse draining CR injectors



DL-UNI50343

Nozzles for sprayers
nozzles $\varnothing = 9$ mm (1 pc.)



DL-UNI50083

Adapter straight with M14 on M12 for tube (4 pcs.)



DL-TVD61414 High pressure tube M14xM14x600mm - 2 pcs.

DL-TVD51414 High pressure tube M14xM14x500mm - 5 pcs.



D-OCDE

Reverse set drain nozzle Denso (4 pcs.)



DL-54127

Leg (foot with regulating bolt) (4 pcs.)



DL-CR50162

Stubs on RAIL (4 pcs.)



DL-UNI30497

Stub instead regulator pressure (5 pcs.)



DL-UNI50088

Angle adapter M14 x M14 (2 pcs.)



Door key (4 pcs.)

CR-Test4E

STAND EQUIPMENT

**DL-CR10015**

Nozzle holder frame with cups (**DL-UNI50342**) for sprayers 7 mm (4 pcs.) and clamping sleeves

DL-UNI31019 Ø=17 (4pcs)

DL-UNI31020 Ø=18,9 (1pc)

DL-UNI31021 Ø=19,2 (1pc)

DL-UNI31022 Ø=21 (1pc)

DL-UNI31231 Ø=21,4 (1pc)

**DL-CR30522KIT**

Pressure accumulator RAIL 1 (distributive) for 3 regulators pressure for checking injectors and CR pumps.

Installed on a stand.

**DL-CR31257**

Pressure accumulator RAIL 2 for checking injectors and pumps with cooling

(for 2 pressure regulators)

Installed on a stand.

**DL-CR31053KIT**

RAIL 3 pressure accumulator for 3 pressure regulators (with cooling)

to test pumps.

Installed on a stand.

CR-Test4E

STAND EQUIPMENT

**DL-UNI50008**

Bracket for pumps,
Bosch standard 125 mm installed
at the stand

FLANGES

**DL-UNI30428**

Mounting flange for injection pump
107 mm CP-3, installed on the stand

**DL-UNI30465**

Mounting flange for injection pump CR
(BMW, RENAULT, MB, Peugeot)

**DL-UNI30464**

Mounting flange for injection pump
CR (MB)

**DL-UNI30474**

Mounting flange for injection pump
MAN CP3 MAN, similar to Bosch
1685720258

**DL-UNI30884**

Mounting flange for injection pump MAN
CP3.4, similar to Bosch 1685720312

**DL-UNI30886**

Mounting flange for injection pump
107 mm CP2 Bosch 0445020036 (Renault).

**DL-CR30860**

Mounting flange for injection pump CR
DENSO HP2 , HP3.

COUPLINGS

**DL-CR31251**

Coupling cone 24mm for
High pressure fuel pump CR CP-3

**DL-CR31271**

Coupling cone 17mm for
checks of CR pumps and high pressure
fuel pump VE

**DL-CR31269**

Cone coupling 19mm for
checks of CR pumps and high pressure
fuel pump VE

**DL-CR31248**

Coupling spline (11 spline) for
testing pumps MAN CR CP-3

**DL- UNI31025**

Coupling for injection pump Bosch CP1
(included insert
UNI31028 with groove width
8 mm) and for high pressure fuel pump
VDO

(included insert UNI31027 with 9 mm
groove). Can be used on Bosch stands
instead of coupling 1685702090.

CR-Test4E

STAND EQUIPMENT

**DL-FMDE064**

Hose for measuring the "supply" of the injection pump" from the pressure accumulator to the fitting entrance to the cooling radiator (RAIL -CR PUMP FM1) $\varnothing 12 \times 3/8 \times 200 \text{mm}$ with bolt, Banjo fitting and 2 gaskets. 1 PC.

**DL-FMDE025**

Set of 2 hoses for connection from the fittings on the front panel "CR PUMP FM1" and "CR PUMP FM2" to connectors "IN1" and "IN2" of the controller flow measurement "FMDE". (hoses installed on the stand). The kit includes:

- Hose $3/8 \times 3/8 \times 250 \text{mm}$ - 1 pc.
- Hose $3/8 \times 3/8 \times 350 \text{mm}$ - 1 pc.

**DL-FMDE045**

Set of 2 hoses for connection from fittings "OUT 1" and "OUT 2" flow measurement controller "FMDE" to the fittings drain into the tank of the stand (hoses are installed on the stand)
The set includes:

- Hose $3/8 \times 3/8 \times 1550 \text{mm}$ - 1 pc.
- Hose $3/8 \times 3/8 \times 1550 \text{mm}$ - 1 pc.

**DL-1CP2304**

Set of 5 hoses for pumps CP1, CP2, CP3. The set includes:

- Hose $\varnothing 12 \times 3/8 \times 700 \text{mm}$ - 1pc.
- Hose $\varnothing 12 \times 3/8 \times 800 \text{mm}$ - 1 pc.
- Hose $\varnothing 12 \times 3/8 \times 850 \text{mm}$ - 1 pc.
- Hose $\varnothing 12 \times 3/8 \times 700 \text{mm}$ - 1pc.
- Hose $\varnothing 12 \times 3/8 \times 800 \text{mm}$ - 1 pc.
- Hose $\varnothing 12 \times 3/8 \times 850 \text{mm}$ - 1 pc.

**DL-2UMS004**

Set of 7 hoses for various connections. The set includes:

- Universal hose $\varnothing 8 \times 3/8 \times 1000 \text{mm}$. 3 pcs.
- Universal hose $\varnothing 10 \times 3/8 \times 1000 \text{mm}$. 4 pcs.

CR-Test4E

STAND EQUIPMENT

Connection set

DL-KUK0040



Kit includes :

- Conical fitting 3/8 "x10 mm - 4 pcs.;
- Taper fitting 3/8"x8 mm - 3 pcs.;
- Clamp Ø15 - 7 pcs.;
- Clamp Ø10 - 7 pcs.;
- Banjo fitting Ø16 mm x 10 mm – 2 pcs.;
- Banjo fitting Ø14 mm x 10 mm – 2 pcs.;
- Banjo fitting Ø12 mm x 8 mm – 2 pcs.;
- Bolt Banjo M16 – 2 pcs.;
- Bolt Banjo M14 – 2 pcs.;
- Bolt Banjo M12 – 6 pcs.;
- Gasket Ø12 mm - 16 pcs.;
- Gasket Ø14 mm – 12 pcs.;
- Gasket Ø16 mm - 12 pcs.;
- Gasket Ø21 mm (1/2") – 1 pc.;
- Plastic fitting for VDO pumps (Siemens) – 1 pc.
- Fitting 1/2"x3/8" - 1 pc.;
- Fitting M16x1.5x3/8" – 1 pc.
- Adapter M12xM16 (pitch 1.5 mm) - 4 pcs.
- Adapter M12xM14 (pitch 1.5 mm) - 4 pcs.
- Adapter M12xM12vn (pitch 1.5 mm) - 4 pcs.

CR-Test4E

STAND EQUIPMENT

**0 281 002 842**Pressure sensor
Bosch (2pcs) on Rail,
installed on the stand**0 281 002 494**pressure regulator
Bosch (5pcs) on Rail,
installed on the stand**DL-CAU001**

Cable for BOSCH injectors (universal)

**DL-CAU002**

Cable for Delphi injectors (C2i, C3i)

**DL-CAU003**

Delphi injector cable (C3i)

**DL-CAU004**

Cable for injectors BOSCH, SIEMENS

**DL-CAU005**

Cable for BOSCH injectors

**DL-CAU007**

Cable for cargo injectors

**DL-CAU006**

Universal cargo injector cable

**DL-CAU009**

Pressure sensor cable

**DL-CAU010**

Pressure regulator connection cable

CR-Test4E

OPTIONAL EQUIPMENT AND ACCESSORIES

**DL-MOK**

Coupling adapter with check valve
Ø 6 x Ø 6mm with collet

**DL-CR50120**

Valve for response time (DELPHI)

**DL-CR50136**

Check valve
BOSCH electromagnetic injectors on the stand

**DL-CR50210**

Return pressure valve for testing piezo injectors
SIEMENS at the booth

**DL-CR50177**

Return pressure valve for
Bosch piezo injectors



CR-Test4E

OPTIONAL EQUIPMENT AND ACCESSORIES

**DL-CR50013**

Universal adapter for CR truck injectors (Bosch , Denso, Delphi Smart) for supply and backflow lines at angles of 0°, 4° and 13°. It is used both for testing nozzles on test benches, and when checking the spray part of nozzles on a hand press.





**DL-CR50140**

Adapter for truck injectors CR Denso, including Volvo21952974 for connecting the supply and overflow drain

CR-Test4E

OPTIONAL EQUIPMENT AND ACCESSORIES

ADAPTERS FOR TESTING CARGO INJECTORS

					
DL-02 DL-CR31046	DL-04A DL-CR30848	DL-05N DL-CR31048	DL-06 DL-CR31440	DL-07 DL-CR31044	DL-08 DL-CR31045
BOSCH MAN Ø 29MM	BOSCH RENAULT Ø 32MM	CUMMINS	DENSO Ø 27MM	DENSO Ø 23,5MM	BOSCH MAN Ø 26MM
					
DL-09 DL-CR31439	DL-010 DL-CR31047	DL-011 DL-CR30985	DL-012 DL-CR30036	DL-013 DL-CR30968	DL-014 DL-UNI30038
BOSCH VOLVO Ø 28MM	CUMMINS	SIEMENS VDO FORD	CRIN BOSCH SISU Ø 26,6MM	DELPHI SMART INJECTOR	DENSO
					
DL-015 DL-CR30822	DL-016 DL-CR31486	DL-017 DL-UNI30037	DL-018 DL-CR30595	DL-019 DL-CR30804	DL-020 DL-CR30596
DENSO Ø 18,5 MM Caterpillar, Perkins	SCANIA 2/4 pin	BOSCH DEUTZ Ø 21,5MM	CURSOR 9	BOSCH MTU	SCANIA 4 PIN
					
DL-021 DL-CR31565	DL-022 DL-CR31566	DL-023 DL-CR31567	DL-024 DL-CR31620	DL-025 DL-CR31625	DL-026 DL-CR31626
BOSCH CRIN3 0445124015	Caterpillar 3809888	Delphi Smart injector Mercedes	DAF-SMART injector	DELPHI CRIN DAF EURO 6 SMART INJ	CUMMINS
					
DL-027 DL-CR31698	DL-030 DL-CR30818	DL-031 DL-CR31040	DL-032 DL-CR31430	DL-033 DL-CR31479	DL-034 (CR31538)
BOSCH	BOSCH ЯМ3-530	BOSCH 0445120303	BOSCH 0445120134	DENSO	DENSO 1211 11L1063 (095000-121)
					
DL-035 DL-CR31561	DL-036 DL-CR31563	DL-037 DL-CR50304	DL-038 DL-CR31606		
DENSO	Delphi A9362187 Mercedes Actros Euro 6	MB Actros	5296723 DENSO		

CR-Test4E

OPTIONAL EQUIPMENT AND ACCESSORIES

ACCESSORIES FOR CHECKING HEU INJECTORS

HEUI CATERPILLAR 3126B,
CATERPILLAR 3126E и FORD 1998-2003
DIESEL 7.3 FUEL INJECTOR 128-6601,
AD1831489C1 (INTERNATIONAL)



Equipment includes:

1. **DL-HEUI50223** Pump installation adapter nozzles



2. **DL-HEUI50240** Set of hydraulic hoses and HPT 400mm 14x14mm
3. **DL-HEUI50219** Adapter holder with clamping bar
4. **DL-HEUI50230** Adapter cable for connecting the pump injector
5. **DL-UNI50084** Corner adapter M14



Attention! All accessories are sold separately.

HEUI CATERPILLAR C7-C9



Equipment includes:

1. **DL-HEUI50221** Pump installation adapter nozzles



CR-Test4E
CR-JET-4EM**OPTIONAL EQUIPMENT AND ACCESSORIES****DL-KD020****DELPHI INJECTOR CODER
FOR STAND CR-TEST-4E AND CR-JET-4EM****Contents of delivery:**

- | | |
|----------------------------------------|----------------------------------------|
| 1. Control valve | 9. Tap adjustment |
| 2. Vacuum pressure gauge | 10. Electric motor ~230V 50Hz |
| 3. *Pressure accumulator (Rail) | 11. Coupling |
| 4. Sensor for coding | 12. Bracket |
| 5. Pressure valve for Delphi injectors | 13. Vacuum pump |
| 6. Venturi tube | 14. Tee with fitting |
| 7. Signal booster | 15. Connecting hose \varnothing 8mm |
| 8. Connecting tube \varnothing 6mm | 16. Connecting hose \varnothing 10mm |

* for additional order

CR-Test4E
CR-Test-2P

OPTIONAL EQUIPMENT AND ACCESSORIES

DL-UNF20400

A set of sedimentation filters for checking high-pressure fuel pumps
at the stand CR-TEST-4E and CR-TEST-2P

**Contents of delivery:**

1. **DL-UNF20300L** Settling filter (entrance on the left) - 2 pcs.
2. **DL-UNI50211** Extended adapter 3/8" x M14 x 1.5mm - 2 pcs.
3. **DL-UNI31161** Reducer short 3/8" x M14 x 1.5mm - 2 pcs.
4. **DL-UNI50213** mounting bracket filters.

DL-UNF20410

Sump filter kit for checking injectors
at the stand CR-TEST-4E

Designed for pre-cleaning nozzles before their check on the stand.

**Contents of delivery:**

1. **DL-UNF20300L** Settling filter (entrance on the left) - 1 pc.
2. **DL-UNF20300R** Settling filter (entrance on the right) - 1 pc.
3. **DL-UNI31427** Adapter 1/8" x M14 x 1.5mm - 4 pcs.
4. **34-RL020602** Quick adapter straight Ø 6x1/4" – 2 pcs.
5. **34-RL310602** Quick adapter angled Ø 6x1/4" – 2 pcs.
6. **DL-UNI50212** Filter mounting bracket.
7. **DL-UNI30090** Mounting bolt with M14 nut.

CR-Test4E
CR-Test-2P

OPTIONAL EQUIPMENT AND ACCESSORIES



DL-CR31497

Adapter for measuring the pressure of the CR booster pump

ATTENTION!
The adapter is supplied without tube fittings and pressure gauge!

DL-CR31497KIT

Adapter kit for measuring the pressure of the Common Rail feed pump.

Contents of delivery:

1. **DL-SP09570** L-shaped "quick" adapter M5 x 4mm
2. **DL-SP09580** The union "mother" 1/4" x 4 mm for the manometer
3. **DL-P1002** Flexible PVC tube dia.4mm (100cm)
4. **D-12-TV63-016** Pressure gauge 16 bar with bottom fitting 1/4"



DL-ORV9

Air-cooled radiator for testing MAN high-pressure fuel pumps workbenches CR-TEST-2P/CR-TEST-4E

TRIUMF CR-Test-4E
CRUIS CR-JET-4EM

OPTIONAL EQUIPMENT AND ACCESSORIES

Set of split bushings (basic) for installing injectors

- | | | | |
|----|-------------------------------------------------------------------------------------|--------------------|-----------------------------|
| 1. |  | DL-UNI31019 | sleeve with inner Ø 17 mm |
| 2. |  | DL-UNI31020 | sleeve with inner Ø 18.9 mm |
| 3. |  | DL-UNI31021 | sleeve with inner Ø 19.2 mm |
| 4. |  | DL-UNI31022 | sleeve with inner Ø 21 mm |
| 5. |  | DL-UNI31031 | sleeve with inner Ø 21.4 mm |

ATTENTION! All bushings are sold separately.

Set of split bushings (additional) for installing injectors

- | | | | |
|----|-------------------------------------------------------------------------------------|--------------------|---------------------------|
| 1. |  | DL-UNI31015 | sleeve with inner Ø 24 mm |
| 2. |  | DL-UNI31016 | sleeve with inner Ø 25 mm |
| 3. |  | DL-UNI31017 | sleeve with inner Ø 26 mm |

ATTENTION! All bushings are sold separately.

TRIUMF CR-Test-4E
CRUIS CR-JET-4EM

OPTIONAL EQUIPMENT AND ACCESSORIES

C4i-CODE DELPHI C4i injector coding

Software for the CASCADE program that allows code DELPHI C4i injectors on CRUIS, TRIUMF, CR-Test-4E test benches, CR Jet

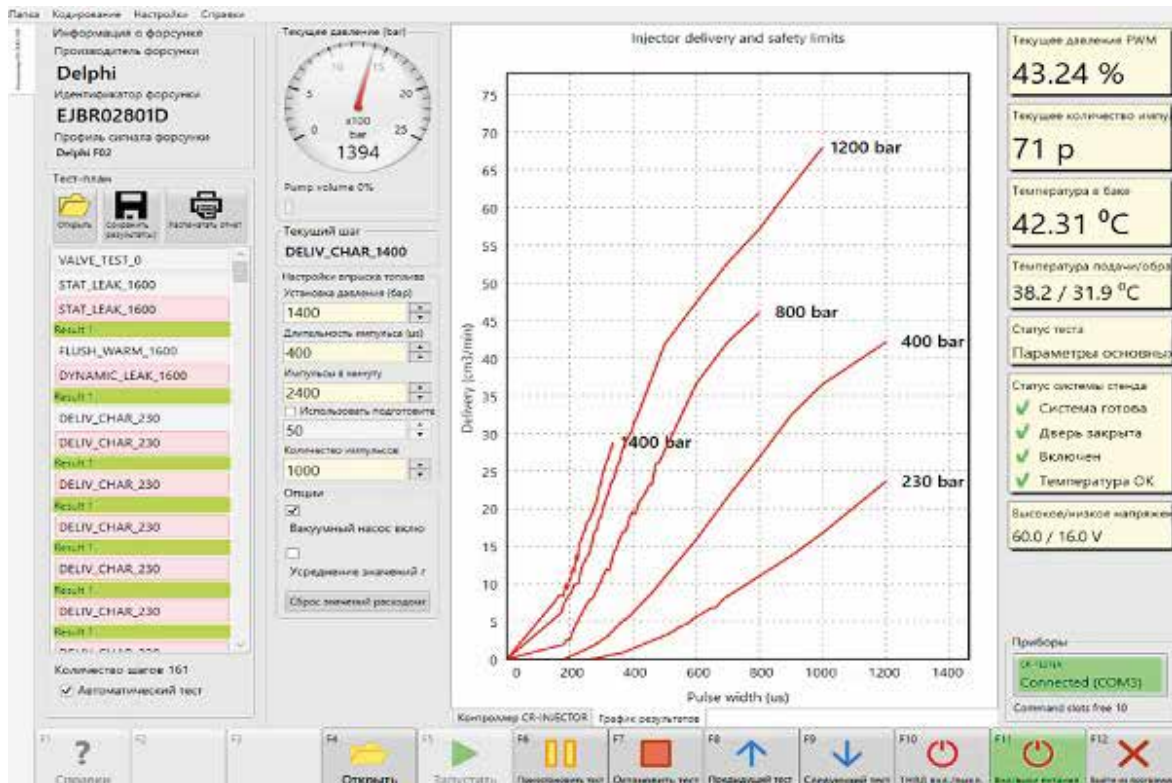

CR-Test2P

Stand **CR-Test2P** for testing high pressure fuel pumps Common Rail system.

The CR-TEST-2P test bench allows you to perform procedures related to the testing of high-pressure fuel pumps of the Common Rail system of various manufacturers (Bosch, Denso, Delphi, VDO (Siemens)). The design of the test stand CR-TEST-2P and the elements of its equipment meet the requirements of international standards in terms of static and dynamic parameters-ISO 4008/1 and ISO 4008/2.

CR-Test-2P – is a CR pump test stand with a 2-channel electronic measurement unit.



CR-Test2P

Software

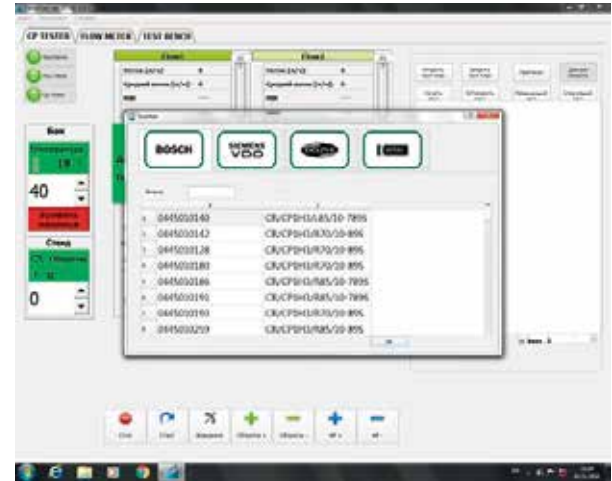

CR-Test2P

STAND EQUIPMENT



FMDE-520

Liquid flow meter for pumps 2-channel. Installed on a stand.



PTC-2520

Pump control controller. Installed on a stand.



DL-TVD61414

High pressure tube M14 x M14 x 600mm for pumps CP2 – 2 pcs.



DL-TVD51414

High pressure tube M14 x M14 x 500mm for pumps CP1, CP3 -1 pc.

0 281 002 842

Safety bosch valve on rail, installed on the stand



DL-CR31053

RAIL 3 pressure accumulator for 3 regulators pressure (with cooling) to test pumps. Installed on a stand.



0 281 002 494

Bosch pressure regulator on Rail (3pcs), installed at the stand



0 281 002 842

Bosch pressure sensor on Rail, installed at the stand



DL-54127

Leg (foot with regulating bolt) (4 pcs.)



Door key (4 pcs.)

CR-Test2P

STAND EQUIPMENT



DL-CAU018

Connection cable
pressure sensor



DL-CAU019

Connection cable
pressure regulator LP-2



DL-CAU020

Connection cable
pressure regulator NR-3



DL-UNI50008

Bracket for pumps,
Bosch standard 125 mm.
Installed on a stand.

FLANGES



DL-UNI30428

Mounting flange for injection pump 107 mm
CP-3, installed on the stand



DL-UNI30465

Mounting flange for injection pump CR
(BMW, RENAULT, MB, Peugeot)



DL-UNI30464

Mounting flange for injection pump CR
(MB)



DL-UNI30474

Mounting flange for injection pump MAN
CP3 MAN, similar to Bosch 1685720258



DL-UNI30884

Mounting flange for injection pump MAN
CP3.4, similar to Bosch 1685720312



DL-UNI30886

Mounting flange for injection pump 107 mm
CP2 Bosch 0445020036 (Renault).



DL-CR30860

Mounting flange for injection pump CR
DENSO HP2 , HP3.

COUPLINGS



DL-CR31251

Coupling cone 24mm for
High pressure fuel pump CR CP-3



DL-CR31271

Coupling cone 17mm for checks of CR
pumps and high pressure fuel pump VE



DL-CR31269

Cone coupling 19mm for checks of CR
pumps and high pressure fuel pump VE



DL-CR31248

Coupling spline (11 spline) for
testing pumps MAN CR CP-3



DL- UNI31025

Coupling for injection pump Bosch CP
1 (included insert UNI31028 with groove
width 8 mm) and for high pressure fuel
pump VDO
(included insert UNI31027 with 9 mm
groove). Can be used on Bosch
stands instead of coupling
1685702090.

CR-Test2P

STAND EQUIPMENT

**DL-FMDE014**

Hose for measuring the "supply" of the injection pump" from the pressure accumulator to the inlet fitting into the cooling radiator (RAIL-CR PUMP FM1) \varnothing 12 x 3/8 x 900 mm with bolt, Banjo fitting and 2 gaskets. - 1 PC.

**DL-FMDE024**

Set of 2 hoses for connection from fittings on the front panel "COOLLER OUT1" and "COOLLER OUT2" to connectors "IN1" and "IN2" of the controller flow measurement "FMDE". (hoses are installed on the stand)

The set includes:

- Hose \varnothing 3/8 x 3/8 x 700 mm - 1 pc.
- Hose \varnothing 3/8 x 3/8 x 800 mm - 1 pc.

**DL-1CP2304**

Set of 5 hoses for pumps CP1, CP2, CP3. The set includes:

- Hose \varnothing 12 x 3/8 x 700 mm - 1 pc.
- Hose \varnothing 12 x 3/8 x 800 mm - 1 pc.
- Hose \varnothing 12 x 3/8 x 850 mm - 1 pc.
- Hose \varnothing 12 x 3/8 x 900 mm - 1 pc.
- Hose \varnothing 3/8 x 3/8 x 1250 mm - 1pc.

**DL-2UMS004**

Set of 7 hoses for various connections. The set includes:

- Universal hose \varnothing 8 x 3/8 x 1000 mm - 3 pcs.
- Universal hose \varnothing 10 x 3/8 x 1000 mm - 4 pcs.

CR-Test2P

STAND EQUIPMENT

Connection set

DL-KUK0040



Kit includes :

- Conical fitting 3/8 "x10 mm - 4 pcs.;
- Taper fitting 3/8"x8 mm - 3 pcs.;
- Clamp Ø15 - 7 pcs.;
- Clamp Ø10 - 7 pcs.;
- Banjo fitting Ø16 mm x 10 mm – 2 pcs.;
- Banjo fitting Ø14 mm x 10 mm – 2 pcs.;
- Banjo fitting Ø12 mm x 8 mm – 2 pcs.;
- Bolt Banjo M16 – 2 pcs.;
- Bolt Banjo M14 – 2 pcs.;
- Bolt Banjo M12 – 6 pcs.;
- Gasket Ø12 mm - 16 pcs.;
- Gasket Ø14 mm – 12 pcs.;
- Gasket Ø16 mm - 12 pcs.;
- Gasket Ø21 mm (1/2") – 1 pc.;
- Plastic fitting for VDO pumps (Siemens) – 1 pc.
- Fitting 1/2"x3/8" - 1 pc.;
- Fitting M16x1.5x3/8" – 1 pc.
- Adapter M12xM16 (pitch 1.5 mm) - 4 pcs.
- Adapter M12xM14 (pitch 1.5 mm) - 4 pcs.
- Adapter M12xM12vn (pitch 1.5 mm) - 4 pcs.

ADDITIONAL EQUIPMENT FOR STANDS



DL-USN0021

Universal cradle for CR pumps

Contents of delivery:

- Rotary stand - 1 pc.
- Flange kit for mounting CR pumps, 6 pcs.
- Set of 4 pump support plates.



ADDITIONAL EQUIPMENT FOR STANDS



DL-ORV2

Cooling stand of radiator-fan type.

External heat exchangers are designed for additional temperature adjustment test liquid. They can be connected to various flows with pressure up to 0.4 MPa.

- Number of radiators: 2
- Connection fitting: M14x1.5
- Supply voltage: ~220V/50Hz
- Power consumption: 20W (0.23A; 0.5A max)
- Dimensions : width 500, height 770, depth 370 (mm)
- Total weight: net ~24kg, gross ~30kg



DL-MSP

Mobile oil station for stands

- Operating pressure 0-10 bar
- Capacity at 3 bar -150 liters / hour
- Fine filter 10 µm
- Tank 20 liters
- Power supply 380 V 50 Hz
- Power consumption 0.37 kW
- Dimensions: width 300, height 800, depth 420 (mm)
- Total weight: net ~54kg, gross ~60kg

ADDITIONAL EQUIPMENT FOR STANDS

**DL-SRS020****Calibration fluid SRS**

ISO 4113-CV-AW (VS 15665-OL-CV),
canister 20 liters.

Used in test benches for
testing of CR injectors, unit injectors
PLD sections.

**CRS Calibrol****Calibration fluid for diesel fuel
equipment**

The CRS Calibrol calibration fluid (20 litre plastic
canister container) is a test oil for testing injectors and
pumps of diesel fuel equipment.

CRS Calibrol is a low viscosity working oil for
calibration with a very tight viscosity tolerance.
It is distinguished by an exceptional level of protection
against wear and corrosion, as well as a low tendency
to foaming.

**DL-SRS200****Calibration fluid SRS**

ISO 4113-CV-AW (VS 15665-OL-CV),
Barrel 200 liters.

Used in test benches for
testing of CR injectors, unit injectors
PLD sections.

ADDITIONAL EQUIPMENT AND ACCESSORIES FOR STANDS



DL-TVD-S

High Pressure Tube
1000x14x14 1800 Bar



DL-TVD-K

High Pressure Tube

DL-TVD-K1000 (1000x14x14 2500 Bar)
DL-TVD-K830 (830x14x14 2500 Bar)
DL-TVD-K700 (700x14x14 2500 Bar)



DL-TVD-B

High Pressure Tube
800x14x14 2500 Bar



DL-TVD-G

High Pressure Tube
650x14x14 2500Bar



DL-TVD

High Pressure Tube for stands and rigs:

DL-TVD31212 (300x12x12), **DL-TVD31214** (300x12x14), **DL-TVD31414** (300x14x14),
DL-TVD41212 (400x12x12), **DL-TVD41214** (400x12x14), **DL-TVD41414** (400x14x14),
DL-TVD51212 (500x12x12), **DL-TVD51214** (500x12x14), **DL-TVD51414** (500x14x14),
DL-TVD61212 (600x12x12), **DL-TVD61214** (600x12x14), **DL-TVD61414** (600x14x14)



DL-TVD-M

High pressure metal tube

DL-TVD-M81412 (800) M14xM12
DL-TVD-M81414 (800) M14xM14
DL-TVD-M61412 (600) M14xM12
DL-TVD-M61414 (600) M14xM14



DL-CR14P2000

Pressure gauge 2000 bar



DL-CR50015

Sensor for coding

ADDITIONAL EQUIPMENT AND ACCESSORIES FOR STANDS

**DL-MOK**

Coupling adapter with check valve
Ø 6 x Ø 6mm with collet

**DL-CR50120**

Valve for response time (DELPHI)

**DL-CR50136**

Check valve
BOSCH electromagnetic injectors on the stand

**DL-CR50210**

Return pressure valve for testing piezo injectors
SIEMENS at the booth

**DL-CR50177**

Return pressure valve for
Bosch piezo injectors



ADDITIONAL EQUIPMENT AND ACCESSORIES FOR STANDS
TRIUMF, CRUIS , CR-TEST-4E AND CR-JET-4EM

Re-equipment of stands CRUIS, TRIUMF, CR-Jet
for electric motors 5.5 kW

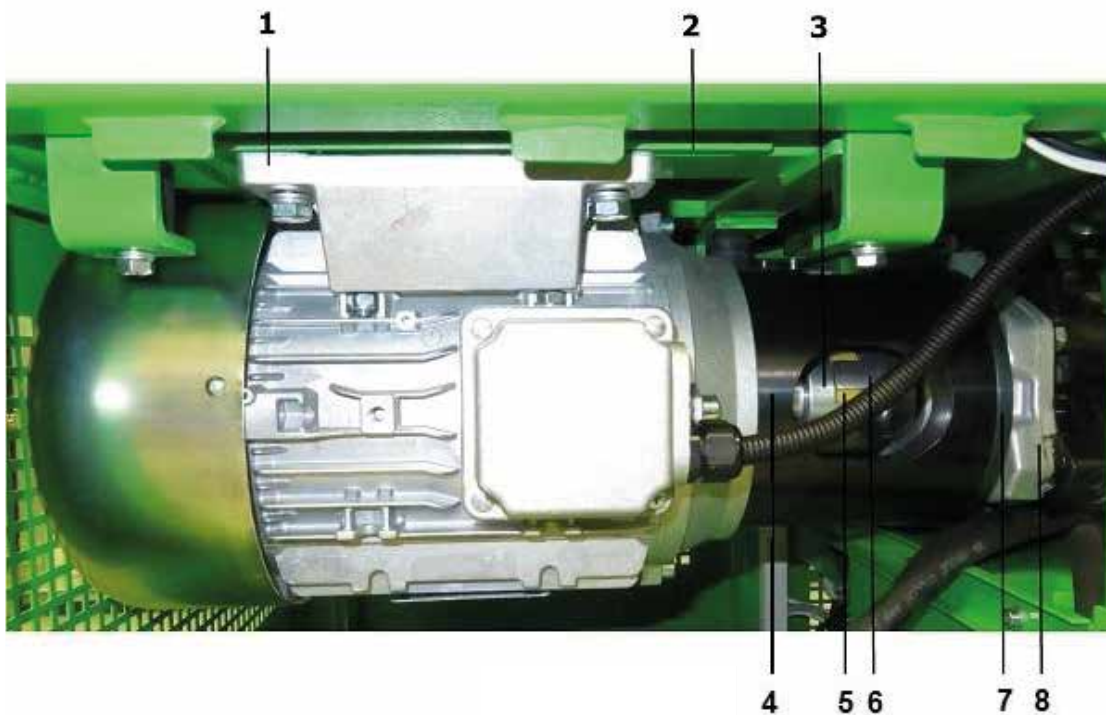

- | | | |
|----|--------------------|-------------------------------------------------------------------|
| 1. | DL-EDF0055 | Electric motor flange 5.5 kW |
| 2. | DL-UNI50277 | Motor Mounting Bracket
5.5 kW for TRIUMF, CR-Jet stands |
| | DL-UNI31521 | Motor Mounting Bracket
5.5 kW for CRUIS stand |
| 3. | DL-UNI31444 | Coupling for the engine for injection pump 0445020139, 0445020088 |
| | DL-UNI31502 | Coupling on the engine for injection pump 0445020078, 0445020119 |
| 4. | DL-UNI31449 | Clip for fastening the injection pump to the electric motor |
| 5. | DL-MUP0060 | Compensatory polyurethane insert |
| 6. | DL-UNI31443 | Coupling for injection pump 0445020139 |
| | DL-UNI31520 | Coupling for injection pump 0445020119 |
| 7. | DL-UNI31459 | Flange for injection pump 0445020078 (119,175,105) |
| 8. | THBД 020139 | High pressure fuel pump
Bosch 0445020139 |

ADDITIONAL EQUIPMENT AND ACCESSORIES FOR STANDS
TRIUMF, CRUIS , CR-TEST-4E AND CR-JET-4EM



DL-EDF0055

Electric motor flange 5.5 kW

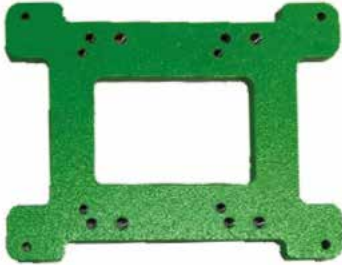

DL-UNI50277

Electric motor mounting bracket 5.5kW
for stands TRIUMF, CR-Jet

DL-UNI31521

Motor mounting bracket 5.5 kW
for stands CRUISE



DL-UNI31444

Coupling for the engine for injection pump 0445020139, 0445020088

DL-UNI31502

Coupling on the engine for injection pump 0445020078, 0445020119



DL-UNI31449

Clip for fastening the injection pump to the electric motor



DL-MUP0060

Compensatory polyurethane insert



DL-UNI31443

Coupling for injection pump 0445020139

DL-UNI31520

Coupling for injection pump 0445020119



DL-UNI31459

Flange for injection pump 0445020078 (119,175,105)



THBД 020139

High pressure fuel pump BOSCH 0445020139

MODERNIZATION KIT FOR CR-JET-4E STANDS.
INSTALLING THE CASCADE PROGRAM

DL-KMS-JET

List of modernization components:

- Electronic part / set of mounting materials
- Delphi piezo transducer for Cascade software
- Personal Computer / PC Installation Accessories
- Frequency converter / Drive control software / Mounting kit
- Vacuum system / Mounting kit
- Mounting elements for inverter and vacuum pump
- Vacuum adjustment unit / Mounting kit
- Vacuum control unit
- Bench retrofit up to 2400 bar / hydraulic kit



The Cascade software has a user-friendly interface. The program contains built-in test plans for testing and coding Bosch, Delphi, Denso, Siemens (VDO) injectors. The functions of creating new test plans, editing built-in ones, as well as creating targets for Delphi C2i, C3i, C4i injectors are available. The results and progress of testing are displayed in graphical form and saved to a file and sent to print.

Cascade software allows coding BOSCH isa / ima cod, Delphi C2i / C3i / C4i*, Denso, VDO Siemens injectors.

Stand working pressure up to 2400 bar.

* coding Delphi C4i in the configuration of the stand 5.5 kW 380 V

PUMP TEST.02

Common-Rail High Pressure Pump Testing Equipment



The kit includes:

1. The **PTC-2520** device is designed to provide user-programmable control signals to Common Rail injection pump pressure regulators to test their performance.
2. Device **FMDE-520**, designed to measure the performance of the Common Rail injection pump in two channels.
3. Tool rack on wheels for easy operation.
4. A set of adapter cables.
5. Liquid fine filters (2 pcs.)
6. Software.



CR-TESTER . CRT-5040



4-channel device for testing and testing Common Rail injectors Bosch, Denso, Delphi, Siemens VDO with a set of cables.

The device has the ability to connect to the FLAGMAN-FLOW beakerless measuring system with the ability to generate correction codes for Delphi C2i / C3i, BOSCH, DENSO injectors

At the CR-TESTER device. CRT-5040 has the functions of controlling the curtain of the metering unit, stopping the high-pressure pump, measuring and controlling the temperature in the tank, measuring the temperature of the back-tested injectors, measuring the injection start time, etc.

Computer control of the set through the CASCADE software.

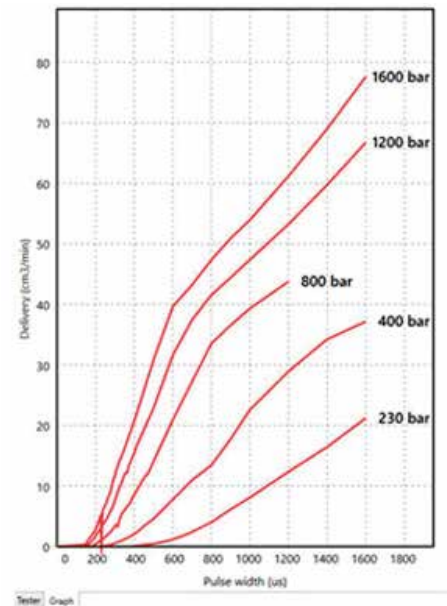
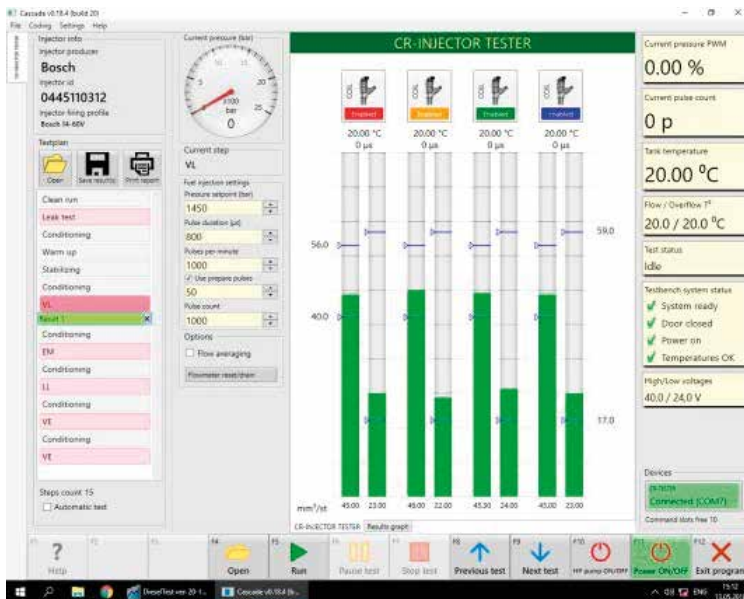



FLAGMAN-FLOW

CR injector dosage measuring unit, 8-channel for CR-TESTER device. CRT-5040

Computer control of the set through the CASCADE software.



FLAGMAN-FULL

CR injector test kit

The FLAGMAN-FULL complex is intended for testing CommonRail injectors manufactured by Bosch, Denso, Delphi, Siemens VDO at the stand.

The measurement takes place in an 8-channel FLAGMAN-FLOW system without a beaker. There is a possibility of retrofitting with a hardware-software complex for coding injectors.

Computer control of the set through the CASCADE software.



FLAGMAN-CODE (FLAGMAN-CODE-L)

CR injector test kit

The FLAGMAN-CODE complex is designed to test common rail injectors manufactured by Bosch, Denso, Delphi, Siemens VDO at the stand.

The measurement takes place in the 8-channel FLAGMAN-FLOW system without beakers. The complex consists of a FLAGMAN-FLOW measuring unit and a CR-TESTER controller. CRT-5040. The complex is also equipped with a vacuum system for coding Deiphi C2i, C3i injectors. Computer control of the set through the CASCADE software.

The FLAGMAN-CODE-L kit is equipped with equipment for installing injectors on a test bench.



DL-CR50015

Sensor for coding



FLAGMAN-CODE

CR injector test kit

The FLAGMAN-FULL complex is intended for testing CommonRail injectors manufactured by Bosch, Denso, Delphi, Siemens VDO at the stand.

The measurement takes place in an 8-channel beakerless FLAGMAN-FLOW system. The complex consists of a FLAGMAN-FLOW measuring unit and a CR-TESTER controller. CRT-5040. The complex is also equipped with a vacuum system for coding Deiphi C2i, C3i injectors. Computer control of the set through the CASCADE software.



DL-CR50015

Sensor for coding

Kit of delivery FLAGMAN-CODE

Measurement unit without beaker FLAGMAN-FLOW	1 pc
Controller CR-TESTER. CRT-5040	1 pc
Vacuum system	1 set
Software	1 pc
Passport (technical description, instruction manual)	1 pc
Set of connecting cables for FLAGMAN-FLOW measuring unit and CR-TESTER controller. CRT-5040	1 set
Extension cord for injector cables: "Injector" socket -1.5m	1 pc
Adapter cable for injectors	1 set
Adapter cable for high pressure regulators	1 pc
Adapter cable for low pressure regulators	1 pc
Adapter cable for pressure sensor	1 pc
Power cable 220 V	1 pc
Connectors for self-manufacturing of cables into sockets: "Protection", "TanktC", "RegtC", "Cycle", "Pump", "Invertor", "Rpm"	1 set
Temperature sensor for monitoring the temperature of the liquid in the tank: "TanktC" socket	1 pc
Temperature sensors for measuring the temperature of the TJ backflow	4 pcs
Reed switch for connecting a protective screen: "Protection" socket	1 pc
Fuse 3A	1 pc
Connecting pipelines	1 set
DL-CR50015 Injection start measuring sensor (for coding)	1 pc



FLAGMAN-CODE-L

CR injector test kit

The FLAGMAN-FULL complex is intended for testing common rail injectors manufactured by Bosch, Denso, Delphi, Siemens VDO at the stand.

The measurement takes place in an 8-channel beakerless FLAGMAN-FLOW system. The complex consists of a FLAGMAN-FLOW measuring unit and a CR-TESTER controller. CRT-5040. The complex is also equipped with a vacuum system for coding Deiphi C2i, C3i injectors. Computer control of the set through the CASCADE software.



DL-CR50015

Sensor for coding

Kit of delivery FLAGMAN-CODE-L

Measurement unit without beaker FLAGMAN-FLOW	1 pc
Controller CR-TESTER. CRT-5040	1 pc
Vacuum system	1 set
Software	1 pc
Passport (technical description, instruction manual)	1 pc
Set of connecting cables for FLAGMAN-FLOW measuring unit and CR-TESTER controller. CRT-5040	1 set
Extension cord for injector cables: "Injector" socket -1.5m	1 pc
Adapter cable for injectors	1 set
Adapter cable for high pressure regulators	1 pc
Adapter cable for low pressure regulators	1 pc
Adapter cable for pressure sensor	1 pc
Power cable 220 V	1 pc
Connectors for self-manufacturing of cables into sockets: "Protection", "TanktC", "RegtC", "Cycle", "Pump", "Invertor", "Rpm"	1 set
Temperature sensor for monitoring the temperature of the liquid in the tank: "TanktC" socket	1 pc
Temperature sensors for measuring the temperature of the TJ backflow	4 pcs
Reed switch for connecting a protective screen: "Protection" socket	1 pc
Fuse 3A	1 pc
Connecting pipelines	1 set
DL-CR50015 Injection start measuring sensor (for coding)	1 pc
DL-CR10015 Nozzle holder frame	1 pc
DL-CR10025 Injector holder bracket assembly	1 pc
DL-CR10006 Protective glass (6mm) or DL-CR10010 Protective glass (10mm)	1 pc



CR-Active

The **CR-Active** signal activator is designed to supply a control signal to the solenoid valve of Common-Rail injectors with a set of cables. It is used to measure the valve stroke when measuring the magnetic gap of electromagnetic Common-Rail injectors.

It has two delivery options: basic and complete. In addition to the signal activator and a set of cables, the complete set includes a stand for injectors, a set of measuring probes and adapters, and a measuring indicator head



CR-NeXT

Armature activator device for Common-Rail injector solenoid valve. The **CR-NeXT** device is designed to supply a control signal to the solenoid valve of Common-Rail injectors. It is mainly used to measure the valve stroke when measuring the magnetic gap of common-rail solenoid injectors.



MONICA CTV-08

The device "**MONICA**" CTV-08 for measuring the actuation current of the electromagnet of Common Rail type injectors

In its case, the device has 2 connectors for connecting a signal cable and a power cable. The measurement takes place by pressing the "Enter" button, after the flashing dot appears on the display, the device is ready for a new measurement. It is also possible to reset the measurement by pressing the "Reset" button



PTC-2520 CP TESTER

Device for testing and testing high-pressure fuel pumps of the Common Rail system with a set of cables.



FMDE-520

Device for testing the performance of fuel pumps of the Common Rail system of various manufacturers: Bosch, Delphi, Denso, Siemens, Cummins on a test bench.

It is a 2-channel liquid flow meter (pump supply and return discharge) in various modes, with digital information output to a backlit liquid crystal display.

CRISTINA

The **CRistina** complex is designed for assembling injectors of the COMMON RAIL BOSCH, DELPHI, DENSO systems using a technology that allows you to calculate and select all the necessary adjusting elements.

CRistina repair- and testing complex is dedicated to assembling and disassembling Bosch, Denso and Delphi Common Rail injectors according to manufacturer specified steps and mechanical tolerances. The complex offers the ability to measure relevant mechanical tolerances of the injector parts and electrical characteristics of the electromagnet. The assembly/disassembly steps and critical measurement points are presented by convenient step-by-step instructions descriptions and relevant images of the work process itself.

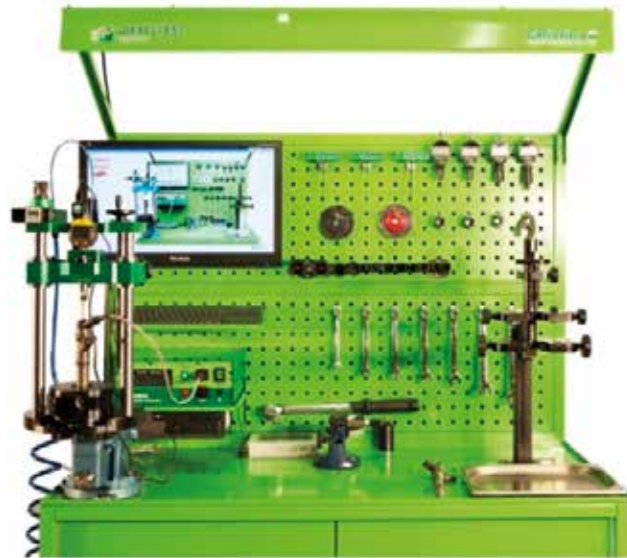

CRistina-PIEZO

Device for testing piezo injectors and piezo element.

Features of the device:

- Feeding signal to activate the injector on the hand press
- Measuring the resistance of a piezo
- Measuring the capacity of the piezo
- Measurement function of the smooth running of the piezo



PR-TESTER.V05

Electronic pressure gauge
2 channel

DL-UNI20061

**Delivery set for measurement
pressure on 2 CHANNELS:**

1. **DL-UNI20065** Electronic pressure gauge
2. **DL-UNI20071** Main adapter cable for 2-channel connection - 1 pc.
3. **DL-UNI20072** Adapter cable for pressure sensor BOSCH type 1 – 2 pcs.
4. **DL-UNI20073** Adapter cable for pressure sensor BOSCH 2 type – 2 pcs.
5. **DL-UNI20074** DELPHI pressure sensor adapter cable – 2 pcs.
6. **DL-UNI20075** Adapter cable for universal for pressure sensor - 2 pcs.
7. Charger
8. The passport



PR-TESTER.V05

Electronic pressure gauge
2 channel

DL-UNI20060

**Delivery set for measurement
pressure on 1 CHANNEL:**

1. **DL-UNI20065** Electronic pressure gauge
2. **DL-UNI20070** Main adapter cable for single-channel connection – 1 pc.
3. **DL-UNI20072** Adapter cable for pressure sensor BOSCH type 1 – 1 pc.
4. **DL-UNI20073** BOSCH pressure sensor adapter cable 2 type – 1 pc.
5. **DL-UNI20074** DELPHI pressure sensor adapter cable – 1 pc.
6. **DL-UNI20075** Universal adapter cable for pressure sensor - 1 pc.
7. Charger
8. The passport





DL-UNI20065

PR-TESTER.V05

Electronic pressure gauge included with charger



DL-UNI20077

adapter cable for pressure sensor BOSCH 1500 bar



DL-UNI21030

mounting bracket electronic manometer



DL-UNI30237

Pressure gauge leg (fitting) G1/2 with nut M12 x 1.25 mm

DL-UNI30445

Manometer leg (fitting) M20 x 1.5mm with nut M12 x 1.25 mm



DL-CR10058

DL-CR10059

DL-CR10060

Pressure sensor 1500 bar

DL-UNI20065 PR-TESTER.V05

Electronic pressure gauge suitable for manual presses:



DL-RP420

(without pressure sensor)

DL-RP425

(with pressure sensor 1500 bar)

Hand press RP 400 for injector testing with electronic pressure gauge DL-UNI20065

Contents of delivery:

- mechanical press - 1 pc.
- connecting tube – 2 pcs.
- electronic pressure gauge with cable – 1 pc.
- battery charger - 1 pc.
- pressure sensor (for RP 425) for 1500 bar – 1 pc.



DL-RP520

(without pressure sensor)

DL-RP525

(with pressure sensor 1500 bar)

ZECA hand press for injector testing with electronic pressure gauge DL-UNI20065

Contents of delivery:

- mechanical press - 1 pc.
- connecting tube – 2 pcs.
- electronic pressure gauge with cable – 1 pc.
- battery charger - 1 pc.
- pressure sensor (for RP 525) for 1500 bar – 1 pc.

BASIC KITS FOR CR NOZZLE TESTING

WITH THE HELP OF A MEASURING BLOCK. FROM
POSSIBILITY OF CONNECTING TO ELECTRONIC MEASURING
FLAGMAN-MUFI-CR UNIT AND CODING RETROFIT
FLAGMAN CODE.



DL-CR10030

A set of basic equipment for testing CR injectors with a controller CR-TESTER CRT-5040 and High pressure fuel pump Basic equipment kit designed to test Common Rail injectors various manufacturers (Bosch, Denso, Delphi, VDO (Siemens) Cummins, Caterpillar, AZPI).

The **DL-CR10030** set is completed with a **DL-CR00088** injection pump with a working pressure of 1800 bar.

DL-CR10031

Basic equipment kit for testing CR injectors with controller CR-TESTER CRT-5040 without injection pump kit CP3 **DL-CR00088**

DL-CR10020

Basic kit for testing CR injectors without controller CR-TESTER **CRT-5040**

DL-CR10021

Basic kit for testing CR injectors without controller CR-TESTER CRT-5040 and injection pump CP3 **DL-CR00088**

DL-CR00139

The injection pump kit **DL-CR00139** is used with a working pressure of 2400 bar and is supplied by separate order. Also, when installing **DL-CR00139** in the basic equipment kit, it is necessary to replace the sensor and pressure regulator for 2400 Bar and 2200 Bar, respectively.

BASIC KITS FOR CR NOZZLE TESTING

DL-CR10030 Basic equipment kit for testing CR injectors with controller CR-tester CRT-5040 and injection pump. The basic equipment kit is designed to test CommonRail injectors from various manufacturers (Bosch, Denso, Delphi, VDO (Siemens) Cummins, Caterpillar, AZPI).

The injection pump kit **DL-CR00139** is used for operating pressures of 2400 bar or 2200 bar and is available upon separate order. When installing DL-CR00139 in the basic equipment kit, it is necessary to replace the sensor and pressure regulator with 2400 bar or 2200 bar, respectively.

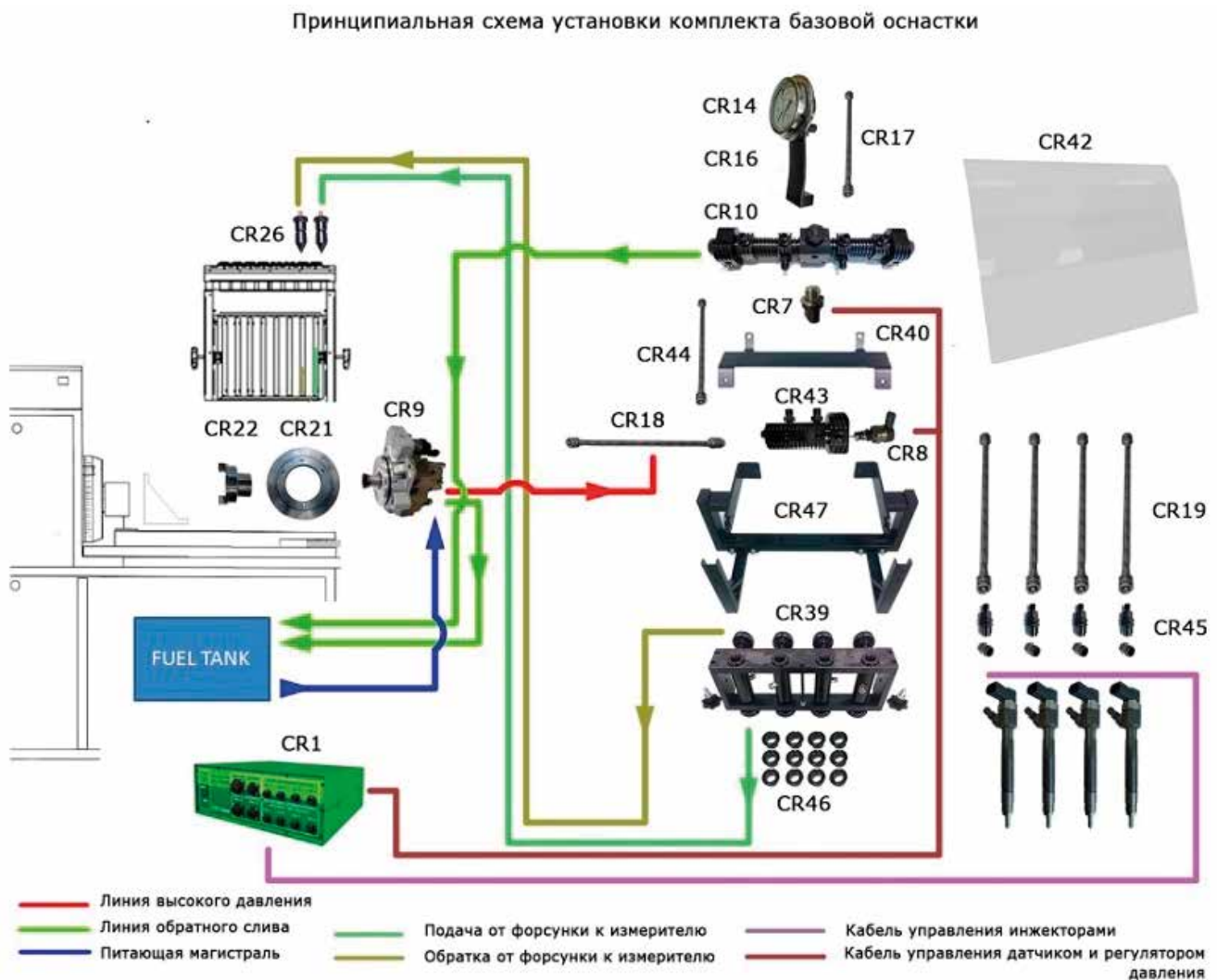

DL-CR10030

EQUIPMENT KIT FOR TESTING CR INJECTORS

CR1	Common Rail Injector Test Controller	CRT-5040	1 pc
	Pressure sensor 1800 bar	DL-CR10050	1 pc
CR7	*Pressure sensor 2200 bar	DL-CR10052	1 pc
	*Pressure sensor 2400 bar	DL-CR10053	1 pc
	Pressure regulator 1800 bar	DL-CR10051	1 pc
CR8	*Pressure regulator 2200 bar	DL-CR10054	1 pc
	*Pressure regulator 2700 bar	DL-CR10055	1 pc
CR43	Rail pressure accumulator small	DL-CR30180	1 pc
CR10	Rail pressure accumulator for 2 regulators	DL-CR30181	1 pc
CR43	*Rail pressure accumulator for 2 regulators with cooling	DL-CR30188	1 pc
CR32	*Safety valve for pressure accumulator 1800 bar	DL-CR10056	1 pc
CR32	*Safety valve for pressure accumulator 2400 bar	DL-CR10057	1 pc
CR30	Plug M14 cap	DL-UNI50271	4 pcs
CR19	High pressure pipes M14 x 14 x 400 mm / M12 x 14 x 400 mm for injectors	DL-TVD41414 DL-TVD41214	4 pcs
CR17	High pressure tube M14 x 14 x 300 mm for pressure gauge	DL-TVD31414	1 pc
CR44	High pressure tube M14 x 14 x 300 mm for rail connection	DL-TVD31414	1 pc
CR45	Adapter from M14 to M12 / M12 to M12	DL-UNI50083 DL-UNI50087	4 pcs
CR39	Nozzle holder frame	DL-CR10015	4 pcs
CR46	Bushing set DL-UNI31019 -Ø 17 (4pcs); DL-UNI31020 -Ø 18.9 (1pc); DL-UNI31021 -Ø 19.2 (1pc); DL-UNI31022 -Ø21 (1pc) and DL-UNI31231 -Ø21.4(1pc)	DL-UNI50161	1 set
CR24	Beaker - Clamp for 9mm atomizers	DL-UNI50343	2 pcs
CR47	Bracket - injector frame holder	DL-CR10025	1 pc
CR29	Tube TEFLON for connection of injectors to dia. 6 mm	P1004	16 m
CR31	Plug instead of pressure regulator	DL-UNI30497	2 pcs
CR32	Plug instead of safety valve	DL-CR30493	1 pc
CR36	Backflow connection kit DENSO banjo fitting, bolt M8 x 1 mm, copper washers 2 pcs.	DL-CR20060	4 sets

CR38	Return fitting for "rail" (banjo 12 mm + M12 bolt + rubber-metal washers)	DL-CR20062	2 sets
CR35	A set of fittings for measuring the return flow of fuel from the injectors	DL-24CRM	1 set
CR40	Bracket-holder "rail" on the frame	DL-CR10028	1 pc
CR41	Mounting kit for rail and frame	DL-CR20063	1 set
CR42	Protective cover (plexiglass) + 2 brackets-holders	DL-CR10006	1 pc
CR26	Defoamers	DL-UNI30156	8 pcs
CR28	Quick connect adapters for defoamers	34-RL310602	8 pcs
CR14	Pressure gauge 0-2500 bar	DL-CR14P2500	1 pc
CR15	Adapter 1/2" X M14 (for pressure gauge)	DL-UNI30287	1 pc
CR16	Pressure gauge holder	DL-KM2500	1 pc

Set of equipment injection pump CP3 DL-CR00088 1800 bar

CR9	High pressure fuel pump SR-3 1800 bar	DL-CR10088	1 pc
CR18	High pressure pipe M14 X 14 X 400 mm for injection pump	DL-TVD51414	1 pc
CR21	Pump bracket adapter (diameter 107 mm)	DL-UNI30428	1 pc
CR22	Coupling for connecting the pump to the drive	DL-M24/DL-M19	1 pc
CR34	Rubber hose dia.8 mm for fuel supply to the pump	D-18-806-008	2,4 m
CR38	Fitting (banjo 12 mm + M12 bolt + rubber-metal washers) for injection pump	DL-CR20062	1 set
—	Clamps 13 mm for rubber hoses Φ 8 mm	DL-CR20066	4 pcs
—	Conical fitting M12x1.5, for a hose with a diameter of 8 mm	DL-UNI30112	3 pcs
—	Washer, rubber-metal, M12	D-GM1537AN	5 pcs

***Set of equipment injection pump CP3 DL-CR00139 2400 bar**

CR9	High pressure fuel pump SR-3 2400 bar	DL-CR10139	1 pc
CR18	High pressure pipe M14 X 14 X 400 mm for injection pump	DL-TVD51414	1 pc
CR21	Pump bracket adapter (diameter 107 mm)	DL-UNI30428	1 pc
CR22	Coupling for connecting the pump to the drive	DL-M24	1 pc
CR34	Rubber hose dia.8 mm for fuel supply to the pump	D-18-806-008	2 m
CR38	Fitting (banjo 12 mm + M12 bolt + rubber-metal washers) for injection pump	DL-CR20062	2 sets
—	Clamps 13 mm for rubber hoses Φ 8 mm	DL-CR20066	4 pcs
—	Conical fitting M12x1.5, for a hose with a diameter of 8 mm	DL-UNI30112	3 pcs
—	Washer, rubber-metal, M12	D-GM1537AN	5 pcs

* for additional order

CR INJECTOR TEST KITS

**DL-CR10000**

Basic set of equipment
CR with CR-Tester and with
high pressure fuel pump CP-3

DL-CR10001

CR tool kit
(without pump, without CR-Tester)

DL-CR10000**BASIC EQUIPMENT KIT COMMON RAIL****Electronic part:**

CR1	Signal simulator 4-channel CR-Tester	1 pc
CR2	Cable kit (basic)	1 pc
CR3	Connector-adapter (male) for connecting injectors "on the thread"	1 pc
CR4	Connector-adapter for connecting Delphi injectors	1 pc
CR5	Connector-adapter for connecting MB injectors	1 pc
CR6	Connector-adapter for connecting BMW injectors	1 pc
CR7	Pressure sensor (0281002921 -1800 bar)	1 pc
CR8	Pressure regulator (0281002494)	1 pc

Mechanical part:

CR9	injection pump (CP3) BOSCH	1 pc
CR10	"Rail" for 4 nozzles on 2 RD	1 pc
CR11	Fitting for "Rail" M14xM14 in a set with gaskets	5 pcs
CR12	Fitting for "Rail" M14xM12(M14) in a set with gaskets	1 pc
CR14	Pressure gauge 0-2500 bar D-CR14P2500	1 pc
CR15	Pressure gauge adapter	1 pc
CR16	Pressure gauge holder	1 pc
CR17	High pressure pipes M14 x M12 (M14) x 300 mm for pressure gauge	1 pc
CR18	High pressure pipes M12 x M12 (M14) x 300 mm for injection pump	1 pc
CR19	High pressure pipes M14XM14 x300mm for injectors	4 pcs
CR20	Straight adapter from M14 to M12 for high pressure tube	4 pcs
CR21	Adapter for mounting the pump on a bracket (Ø107mm.)	1 pc
CR22	Coupling for connecting the pump to the drive	1 pc
CR23	BOSCH-DENSO injector adapter	4 pcs
CR24	Adapter-glass for installing DELPHI injectors	4 pcs
CR25	Clamp (collet) for injector nozzles 7mm	4 pcs
CR26	Defoamers	8 pcs
CR27	1/8" adapters for quick connection (Ø 6mm angled)	4 pcs
CR28	1/4" adapters for quick connection (Ø 6mm) straight	8 pcs
CR29	PVC spout Ø 6 mm	16 m
CR30	Plug M14 for "Rail"	4 pcs
CR31	Plug instead of RD	1 pc
CR32	Plug instead of safety valve	1 pc
CR33	Plug M12 instead of return fitting "Rail"	1 pc
CR34	PVC hose 8mm for fuel supply to the pump	1,5 m
CR35	BOSCH injector return fitting	4 pcs
CR36	DENSO injector return fitting	4 pcs
CR37	"Bolts" for DENSO injector return fittings	4 pcs
CR38	Return fitting for "Rail" (banjo12mm + bolt M12 + washers)	2 sets
CR39	Nozzle holder frame	1 pc
CR40	Rail bracket on frame	1 pc
CR41	Mounting kit for "Rail" and frame	1 pc
CR42	Protective cover	1 set

**DL-12CRM**

Reverse flask set
draining CR injectors

**DL-24CRM**

Set of flasks with measuring adapters
return flow of CR injectors

**DL-36CRM**

Connection adapter set
return flow of CR injectors

DL-80CRM**Set of connections for measuring the fuel
backflow from Common Rail injectors**

Kit includes :

1	DL-6015168	Fitting for injectors FORD (Siemens VDO)	4 pcs
2	DL-6015188	Fitting for FORD Transit (Siemens VDO)	4 pcs
3	DL-60151111	Fitting for injectors BOSCH Piezo	4 pcs
4	DL-6015166	Fitting for SIEMENS VDO injectors	4 pcs
5	DL-GSDE	L-shaped fitting with bracket for Denso injectors	4 pcs
6	DL-OCDE	Banjo fitting for Denso injectors	4 pcs
7	DL-6015195	Fitting for DELPHI injectors	4 pcs
8	DL-6015176	Fitting for injectors 0445110368 (BOSCH)	4 pcs
9	DL-6015130	DELPHI injector fitting	4 pcs
10	DL-6015161	Fitting for SIEMENS injectors	4 pcs
11	DL-KLB01	Fitting with bracket for BOSCH injectors	4 pcs
12	DL-SMS01	Clamp long for clamping SIEMENS fitting	4 pcs
13	DL-SMS02	Medium bracket for clamping the SIEMENS fitting	4 pcs
14	DL-SMS03	Bracket standard for clamping the SIEMENS fitting	4 pcs

1

STANDS and EQUIPMENT for testing common rail injectors and pumps

1



DL-6015168

Nozzle fitting
FORD (Siemens VDO)

2



DL-6015188

Nozzle fitting FORD
Transit (Siemens VDO)

3



DL-6015111

Nozzle fitting
BOSCH Piezo

4



DL-6015166

Nozzle fitting
SIEMENS VDO

5



DL-GSDE

Fitting L-shaped with
bracket for injectors
Denso

6



DL-OCDE

Banjo fitting for
Denso injectors

7



DL-6015195

Nozzle fitting DELPHI

8



DL-6015176

Nozzle fitting
0445110368 (BOSCH)

9



DL-6015130

Nozzle fitting DELPHI

10



DL-6015161

Nozzle fitting
SIEMENS

11



DL-KLB01

Union with clamp
for Bosch injectors

12



DL-SMS01

Bracket long for
fitting clamp
SIEMENS

13



DL-SMS02

Bracket medium for
fitting clamp
SIEMENS

14



DL-SMS03

Bracket standard
for fitting clamp
SIEMENS

DL-90CRM**Set of connections for measuring the fuel backflow from Common Rail injectors**

Kit includes :

1	DL-6015168	Fitting for injectors FORD (Siemens VDO)	4 pcs
2	DL-6015188	Fitting for FORD Transit (Siemens VDO)	4 pcs
3	DL-60151111	Fitting for injectors BOSCH Piezo	4 pcs
4	DL-6015166	Fitting for SIEMENS VDO injectors	4 pcs
5	DL-GSDE	L-shaped fitting with bracket for Denso injectors	4 pcs
6	DL-OCDE	Banjo fitting for Denso injectors	4 pcs
7	DL-6015195	Fitting for DELPHI injectors	4 pcs
8	DL-6015176	Fitting for injectors 0445110368 (BOSCH)	4 pcs
9	DL-6015130	DELPHI injector fitting	4 pcs
10	DL-6015161	Fitting for SIEMENS injectors	4 pcs
11	DL-KLB01	Fitting with bracket for BOSCH injectors	4 pcs
12	DL-6015181	Fitting for SIEMENS injectors	4 pcs
13	DL-6015193	Fitting for injectors 0445110550 (BOSCH)	4 pcs
14	DL-SMS01	Clamp long for clamping SIEMENS fitting	4 pcs
15	DL-SMS02	Medium bracket for clamping the SIEMENS fitting	4 pcs
16	DL-SMS03	Bracket standard for clamping the SIEMENS fitting	4 pcs

1



DL-6015168

Nozzle fitting
FORD (Siemens VDO)

2



DL-6015188

Nozzle fitting FORD
Transit (Siemens VDO)

3



DL-6015111

Nozzle fitting
BOSCH Piezo

4



DL-6015166

Nozzle fitting
SIEMENS VDO

5



DL-GSDE

Fitting L-shaped with
bracket for injectors
Denso

6



DL-OCDE

Banjo fitting for
Denso injectors

7



DL-6015195

Nozzle fitting DELPHI

8



DL-6015176

Nozzle fitting
0445110368 (BOSCH)

9



DL-6015130

Nozzle fitting DELPHI

10



DL-6015161

Nozzle fitting
SIEMENS

11



DL-KLB01

Union with clamp
for Bosch injectors

12



DL-6015181

Nozzle fitting
SIEMENS

13



DL-6015193

Nozzle fitting
0445110550 (BOSCH)

14



DL-SMS01

Bracket long for
fitting clamp
SIEMENS

15



DL-SMS02

Bracket medium for
fitting clamp
SIEMENS

16



DL-SMS03

Bracket standard
for fitting clamp
SIEMENS

DL-100CRM**Set of connections for measuring the fuel
backflow from Common Rail injectors**

Kit includes :

1	DL-6015168	Fitting for injectors FORD (Siemens VDO)	4 pcs
2	DL-6015188	Fitting for FORD Transit (Siemens VDO)	4 pcs
3	DL-60151111	Fitting for injectors BOSCH Piezo	4 pcs
4	DL-6015166	Fitting for SIEMENS VDO injectors	4 pcs
5	DL-GSDE	L-shaped fitting with bracket for Denso injectors	4 pcs
6	DL-OCDE	Banjo fitting for Denso injectors	4 pcs
7	DL-6015195	Fitting for DELPHI injectors	4 pcs
8	DL-6015176	Fitting for injectors 0445110368 (BOSCH)	4 pcs
9	DL-6015130	DELPHI injector fitting	4 pcs
10	DL-6015161	Fitting for SIEMENS injectors	4 pcs
11	DL-KLB01	Fitting with bracket for BOSCH injectors	4 pcs
12	DL-6015181	Fitting for SIEMENS injectors	4 pcs
13	DL-6015193	Fitting for injectors 0445110550 (BOSCH)	4 pcs
14	DL-CR31256	Fitting for injectors Denso M8 x 1mm	4 pcs
15	DL-CR31312	Fitting for injectors Denso M8 x 1.25mm	4 pcs
16	DL-CR31254	Fitting for Denso injectors	4 pcs
17	DL-CR31255	Fitting for Denso injectors	4 pcs
18	DL-SMS01	Clamp long for clamping SIEMENS fitting	4 pcs
19	DL-SMS02	Medium bracket for clamping the SIEMENS fitting	4 pcs
20	DL-SMS03	Bracket standard for clamping the SIEMENS fitting	4 pcs

1

STANDS and EQUIPMENT for testing common rail injectors and pumps

1



DL-6015168

Nozzle fitting
FORD (Siemens VDO)

2



DL-6015188

Nozzle fitting FORD
Transit (Siemens VDO)

3



DL-60151111

Nozzle fitting
BOSCH Piezo

4



DL-6015166

Nozzle fitting
SIEMENS VDO

5



DL-GSDE

Fitting L-shaped with
bracket for injectors
Denso

6



DL-OCDE

Banjo fitting for
Denso injectors

7



DL-6015195

Nozzle fitting DELPHI

8



DL-6015176

Nozzle fitting
0445110368 (BOSCH)

9



DL-6015130

Nozzle fitting DELPHI

10



DL-6015161

Nozzle fitting
SIEMENS

11



DL-KLB01

Union with clamp
for Bosch injectors

12



DL-6015181

Nozzle fitting
SIEMENS

13



DL-6015193

Nozzle fitting
0445110550 (BOSCH)

14



DL-CR31256

Nozzle fitting Denso
M8 x 1mm

15



DL-CR31312

Nozzle fitting Denso
M8 x 1,25mm

16



DL-CR31254

Nozzle fitting Denso

17



DL-CR31255

Nozzle fitting Denso

18



DL-SMS01

Bracket long for
fitting clamp
SIEMENS

19



DL-SMS02

Bracket medium for
fitting clamp
SIEMENS

20



DL-SMS03

Bracket standard
for fitting clamp
SIEMENS

DL-120CRM**Set of connections for measuring the fuel
backflow from Common Rail injectors**

Kit includes :

1	DL-6015168	Fitting for injectors FORD (Siemens VDO)	4 pcs
2	DL-6015188	Fitting for FORD Transit (Siemens VDO)	4 pcs
3	DL-60151111	Fitting for injectors BOSCH Piezo	4 pcs
4	DL-6015166	Fitting for SIEMENS VDO injectors	4 pcs
5	DL-GSDE	L-shaped fitting with bracket for Denso injectors	4 pcs
6	DL-OCDE	Banjo fitting for Denso injectors	4 pcs
7	DL-6015195	Fitting for DELPHI injectors	4 pcs
8	DL-7247800	Fitting for DELPHI injectors	4 pcs
9	DL-7271100	Fitting for DELPHI injectors	4 pcs
10	DL-6015176	Fitting for injectors 0445110368 (BOSCH)	4 pcs
11	DL-6015130	DELPHI injector fitting	4 pcs
12	DL-6015161	Fitting for SIEMENS injectors	4 pcs
13	DL-KLB01	Fitting with bracket for BOSCH injectors	4 pcs
14	DL-6015181	Fitting for SIEMENS injectors	4 pcs
15	DL-6015193	Fitting for injectors 0445110550 (BOSCH)	4 pcs
16	DL-CR31256	Fitting for injectors Denso M8 x 1mm	4 pcs
17	DL-CR31312	Fitting for injectors Denso M8 x 1.25mm	4 pcs
18	DL-CR31254	Fitting for Denso injectors	4 pcs
19	DL-CR31255	Fitting for Denso injectors	4 pcs
20	DL-SMS01	Clamp long for clamping SIEMENS fitting	4 pcs
21	DL-SMS02	Medium bracket for clamping the SIEMENS fitting	4 pcs
22	DL-SMS03	Bracket standard for clamping the SIEMENS fitting	4 pcs

1

STANDS and EQUIPMENT for testing common rail injectors and pumps



DL-6015168

Nozzle fitting
FORD (Siemens VDO)



DL-6015188

Nozzle fitting FORD
Transit (Siemens VDO)



DL-60151111

Nozzle fitting
BOSCH Piezo



DL-6015166

Nozzle fitting
SIEMENS VDO



DL-GSDE

Fitting L-shaped with
bracket for injectors
Denso



DL-OCDE

Banjo fitting for
Denso injectors



DL-6015195

Nozzle fitting
DELPHI



DL-7247800

Nozzle fitting
DELPHI



DL-7271100

Nozzle fitting
DELPHI



DL-6015176

Nozzle fitting
0445110368 (BOSCH)



DL-6015130

Nozzle fitting DELPHI



DL-6015161

Nozzle fitting
SIEMENS



DL-KLB01

Union with clamp
for Bosch injectors



DL-6015181

Nozzle fitting
SIEMENS



DL-6015193

Nozzle fitting
0445110550
(BOSCH)



DL-CR31256

Nozzle fitting Denso
M8 x 1mm



DL-CR31312

Nozzle fitting
Denso
M8 x 1,25mm



DL-CR31254

Nozzle fitting
Denso



DL-CR31255

Nozzle fitting
Denso



DL-SMS01

Bracket long for
fitting clamp
SIEMENS



DL-SMS02

Bracket medium for
fitting clamp
SIEMENS



DL-SMS03

Bracket standard
for fitting clamp
SIEMENS

Universal adapter for truck CR injectors (Bosch , Denso, Delphi Smart) for supply and backflow lines at angles of 0°, 4° and 13°**DL-CR50013****Kit includes :**

DL-CR30219	Adapter housing
DL- CR50035	Holding bracket with fitting and fitting for backflow
DL- CR30419	Nozzle for backflow of CR Delphi Smart injectors
DL- CR30238	The fitting extended for connection of giving
DL- CR30225	Standard fitting for supply connection
DL- CR30661	Nozzle for backflow of injectors CR Bosch 0445120147,0445120098
DL- CR30269	A fitting with a fitting for backflow of injectors Delphi, Smart, Denso, Bosch 0445120147, 0445120098
D-27-200078	O-ring for backflow fitting (2pcs). Hex wrench 3mm.

**Universal adapter repair kit****Kit includes :**

1. **D-27-026000** Sealing rubber ring - 1 pc.
2. **D-27-026210** Sealing rubber ring - 1 pc.
3. **D-27-200078** Sealing rubber ring - 4 pcs.

EXAMPLES OF USING THE UNIVERSAL ADAPTER DL-CR50013



**Installation in nozzle adapter
Bosch 0445120218 with direct connection "0°".**

Used:

- **DL-CR30219** Adapter body (wide shelf towards sprayer)
- **DL-CR30225** Standard fitting for supply connection
- **DL-CR50035** Holding bracket with fitting and fitting for backflow



**Installation in nozzle adapter
Bosch 0445120067 with approach angle "13°".**

Used:

- **DL-CR30219** Adapter body (wide shelf towards sprayer)
- **DL-CR30238** The fitting extended for connection of giving
- **DL-CR50035** Holding bracket with fitting and fitting for backflow
- Allen key for fixing the swivel base of the adapter housing by 13°

EXAMPLES OF USING THE UNIVERSAL ADAPTER DL-CR50013



Installation in nozzle adapter

Bosch 0445120147, 0445120098 with direct connection "0°".

Used:

- **DL-CR30219** Adapter body (wide shelf towards sprayer)
- **DL-CR30661** Backflow nozzle
- **DL-CR30225** Standard fitting for supply connection
- **DL-CR30269** Short fitting with backflow fitting



Installation in nozzle adapter

Denso with approach angle "0°".

Used:

- **DL-CR30219** Adapter body (wide shelf towards sprayer)
- **DL-CR30225** Standard fitting for supply connection
- **DL-CR30269** Short fitting with backflow fitting

EXAMPLES OF USING THE UNIVERSAL ADAPTER DL-CR50013

**Installation in nozzle adapter
Delphi Smart with direct "0°" approach.**

Used:

- **DL-CR30219** Adapter body (wide shelf towards sprayer)
- **DL-CR30225** Standard fitting for supply connection
- **DL-CR30419** Nozzle for backflow of nozzles
- **DL-CR30269** Short fitting with backflow fitting

**Adapter for CR Denso truck injectors, incl.
Volvo 21952974 for supply and return connection**

DL-CR50140



Kit includes :

1. **DL-CR31031** Adapter housing
2. **DL-CR30225** Feed connector
3. **DL-CR50035** Holding bracket with fitting and fitting for backflow

ADAPTERS FOR TESTING CARGO INJECTORS



DL-01 (UIS31524)

Adapter for testing mechanical injectors sections PLD MB ACTROS and MB ATEGO

Contents of delivery:

adapter - 1 pc, cola receiver (7mm) - 1 pc, side fitting - 1 pc, fitting - 1 pc, screw - 1 pc.



DL-02 (DL-CR31046)

**Truck injector adapter
Bosch 0445120098, 0445120147 MAN Ø 29mm**

Contents of delivery:

adapter - 1 pc, cola receiver (7mm) - 1 pc, side fitting - 1 pc, fitting - 2 pcs, screw - 1 pc.



DL-04A (DL-CR30848)

**Adapter for truck injectors RENAULT Ø 32mm
0445120020, 0445120019, 0445120003, 0445120004**

Contents of delivery:

adapter - 1 pc, cola receiver (9mm) - 1 pc, side fitting - 1 pc, fitting - 2 pcs, screw - 1 pc.



DL-05N (DL-CR31048)

**Truck injector adapter
CUMMINS Be110/162kW;
KAMAZ 11TS 150/133kW, 20TS 207kW, 25TS 207W
0445120123**

Contents of delivery:

adapter - 1 pc, cola receiver (7mm) - 1 pc, side fitting - 1 pc, fitting - 2 pcs, screw - 1 pc.



DL-06 (DL-CR31440)

**Truck injector adapter
DENSO Ø 27mm**

Contents of delivery:

adapter - 1 pc, cola receiver (7mm) - 1 pc, side fitting - 1 pc, fitting - 2 pcs, screw - 1 pc.

ADAPTERS FOR TESTING CARGO INJECTORS



DL-07 (DL-CR31044)

Truck injector adapter
DENSO Ø 23.5mm

Contents of delivery:

adapter - 1 pc, cola receiver (7mm) - 1 pc,
side fitting with axial compression of the core without rotation - 1 pc,
fitting - 2 pcs, screw - 1 pc.



DL-08 (DL-CR31045)

Truck injector adapter
MAN Ø 26mm

Contents of delivery:

adapter - 1 pc, cola receiver (7mm) - 1 pc,
side fitting - 1 pc, fitting - 2 pcs, screw - 1 pc.



DL-09 (DL-CR31439)

Truck injector adapter
MAN Ø 28mm (Volvo) 0445120044

Contents of delivery:

adapter - 1 pc, cola receiver (7mm) - 1 pc,
side fitting 1 pc, fitting 2 pcs, screw - 1 pc.



DL-010 (DL-CR31047)

Truck injector adapter
CUMMINS 0445120121, 0445120125

Contents of delivery:

adapter - 1 pc, cola receiver (7mm) - 1 pc,
side fitting - 1 pc, fitting - 2 pcs, screw - 1 pc.



DL-011 (DL-CR30985)

Adapter for connecting the return flow of cargo injectors
SIEMENS VDO FORD

Contents of delivery:

adapter - 1 pc, cola receiver (7mm) - 1 pc,
fitting - 2 pcs, screw - 1 pc.

ADAPTERS FOR TESTING CARGO INJECTORS

**DL-012 (DL-CR30036)**

Truck injector adapter
Bosch 0445120063

Contents of delivery:

adapter - 1 pc, cola receiver (7mm) - 1 pc,
side fitting - 1 pc, fitting - 2 pcs, screw - 1 pc.

**DL-013 (DL-CR30968)**

Truck injector adapter
Delphi Smart

Contents of delivery:

adapter - 1 pc, cola receiver (7mm) - 1 pc,
side fitting with axial compression of the core without rotation - 1 pc,
fitting - 2 pcs, screw - 1 pc.

**DL-014 (DL-CR30038)**

Adapter for connecting the return flow of cargo injectors
Denso 24mm

Contents of delivery:

adapter - 1 pc, cola receiver (7mm) - 1 pc,
fitting - 2 pcs, screw - 1 pc.

**DL-015 (DL-CR30822)**

Adapter for connecting the return flow of cargo injectors
Denso 18.5mm, Caterpillar, Perkins

Contents of delivery:

adapter - 1 pc, cola receiver (7mm) - 1 pc,
fitting - 2 pcs, screw - 1 pc.

**DL-016 (DL-CR31486)**

Adapter for connecting the return line of SCANIA 2/4 pin cargo injectors

Contents of delivery:

adapter - 1pc, cola receiver (9mm) - 1pc,
fitting - 2 pcs, screw - 1 pc.

**DL-017 (DL-UNI30037)**

Adapter for connection of return to cargo injectors

Bosch 0445120066

Contents of delivery:

adapter - 1 pc, cola receiver (7mm) - 1 pc,
fitting - 2 pcs, screw - 1 pc.

ADAPTERS FOR TESTING CARGO INJECTORS

**DL-018 (DL-CR30595)**

Adapter for connecting the return flow of trucks nozzles Cursor 9

Contents of delivery:

adapter - 1 pc, cola receiver (7mm) - 1 pc, fitting - 2 pcs, screw - 1 pc.

**DL-019 (DL-CR30804)**

Adapter for connecting the return flow of trucks injectors Bosch MTU

Contents of delivery:

adapter - 1 pc, cola receiver (7mm) - 1 pc, fitting - 2 pcs, screw - 1 pc.

**DL-020 (DL-CR30596)**

Adapter for connecting the return flow of trucks injectors MB 4PIN

Contents of delivery:

adapter - 1 pc, cola receiver (7mm) - 1 pc, fitting - 2 pcs, screw - 1 pc.

**DL-021 (DL-CR31565)**

BOSCH injector test adapter
CRIN3 0445124015

Contents of delivery:

adapter - 1 pc, cola receiver (7mm) - 1 pc, fitting - 1 pc, screw - 1 pc.

**DL-022 (DL-CR31566)**

Truck injector test adapter
Caterpillar 3809888

Contents of delivery:

adapter - 1 pc, cola receiver (7mm) - 1 pc, side fitting with axial compression of the core without rotation - 1 pc, fitting - 2 pcs, screw - 1 pc.

**DL-023 (DL-CR31567)**

Truck injector test adapter
Delphi Smart injector Mercedes

Contents of delivery:

adapter - 1 pc, cola receiver (7mm) - 1 pc, side fitting with axial compression of the core without rotation - 1 pc, fitting - 2 pcs, screw - 1 pc.

ADAPTERS FOR TESTING CARGO INJECTORS

**DL-024 (DL-CR31620)**

**Adapter for connecting backflow of injectors
CR DAF-SMART injector (DAF-1826007)**

Contents of delivery:

adapter - 1 pc, cola receiver (7mm) - 1 pc,
fitting - 2 pcs, screw - 1 pc.

**DL-025 (DL-CR31625)**

**Adapter for connecting backflow of injectors
DELPHI CRIN DAF EURO 6 SMART INJ**

Contents of delivery:

adapter - 1 pc, cola receiver (7mm) - 1 pc,
side fitting - 1 pc, fitting - 2 pcs, screw - 1 pc.

**DL-026 (DL-CR31626)**

**Adapter for connecting the supply and backflow
injectors CUMMINS D26**

Contents of delivery:

adapter - 1 pc, cola receiver (7mm) - 1 pc,
side fitting - 1 pc, fitting - 2 pcs, screw - 1 pc.

**DL-027 (DL-CR31698)**

Truck injector adapter

**Bosch 0445120086, 0445120087, 0445120127, 0445120265,
0445120266, 0445120389, 0445120391, 0445120412, 0445120462,
0445120474, 0445120524, 0445120526, 0445120527, 0445120531,
0445120562, 0445120571, 0445120580.**

Contents of delivery:

adapter - 1 pc, cola receiver (7mm) - 1 pc,
side fitting - 1 pc, fitting - 2 pcs, screw - 1 pc.

**DL-030 (DL-CR30818)**

Truck injector adapter

Bosch 0445120178 YaMZ-530

Contents of delivery:

adapter - 1 pc, cola receiver (7mm) - 1 pc,
side fitting - 1 pc, fitting - 2 pcs, screw - 1 pc

**DL-031 (DL-CR31040)**

**Adapter for connecting backflow of injectors
Bosch 0445120303**

Contents of delivery:

adapter - 1 pc, cola receiver (7mm) - 1 pc,
fitting - 2 pcs, screw - 1 pc.

ADAPTERS FOR TESTING CARGO INJECTORS



DL-032 (DL-CR31430)

**Backflow connection adapter
injectors Bosch 0445120134**

Contents of delivery:

adapter - 1 pc, cola receiver (7mm) - 1 pc,
fitting - 2 pcs, screw - 1 pc.



DL-033 (DL-CR31479)

**Adapter for connecting the return flow of trucks
injector DENSO 7140 08S02953 33800-52000**

Contents of delivery:

adapter - 1 pc, cola receiver (7mm) - 1 pc,
fitting - 2 pcs, screw - 1 pc.



DL-034 (DL-CR31538)

**Nozzle Backflow Adapter
DENSO 1211 11L1063 (095000-121)**

Contents of delivery:

adapter - 1 pc, sealing rubber ring - 2 pcs.
fitting - 1 pc, locking screw - 1 pc.



DL-035 (DL-CR31561)

**Nozzle Backflow Adapter
DENSO 2300/3100 07T00365 (5213417 Komatsu)**

Contents of delivery:

adapter - 1 pc, cola receiver (7mm) - 1 pc,
fitting - 2 pcs, screw - 1 pc.



DL-036 (DL-CR31563)

**Injector test adapter
Delphi A9362187 Mercedes Actros Euro 6**

Contents of delivery:

adapter - 1 pc, cola receiver (7mm) - 1 pc,
fitting - 1 pc, screw - 1 pc.



DL-037 (DL-CR50304)

**Adapter for testing 4-pin
injectors MB Actros**

Contents of delivery:

adapter - 1 pc, clamp - 1 pc, bracket - 1 pc,
set of screws - 1 pc, fitting - 2 pcs.

ADAPTERS FOR TESTING CARGO INJECTORS

**DL-037KIT (DL-CR50304KIT)**

Комплект для проверки 4-х контактной форсунки MB Actros 0445120303

Contents of delivery:

- **DL-037** Adapter for fixing the 4-pin nozzle MB Actros - 1 pc.
- **DL-SHL02037** 20mm x 150mm reverse drain hose for the stand - 1 pc.
- **DL-ADS04020** Adapter cable with 2 connectors - 1 pc.
- **DL-UNI31616** Fitting with external threads G1/4 to G1/8- 1 piece.
- **34-GU11-21-0014** Fitting quick-release adapter G1/4", type "dad" - 1 piece.
- **DL-34-N3-213B** Fitting Ø 6mm x 1/8"- 1 piece.
- **D-GM1537AN** Rubber-metal washer Ø12mm - 1 piece.
- Rubber-metal washer Ø10mm - 2 pcs.

**DL-038 (CR31606)**

Connection adapter injectors 5296723 DENSO

Contents of delivery:

Adapter - 1 pc, cola receiver (7mm) - 1 pc, fitting (quick adapter) - 2 pcs, screw-"butterfly" - 1 pc.

**DL-CR30429 (DL-EA)**

Side fitting for cargo adapters

**DL-CR30972**

Feed connector for weight adapter

**DL-CR50303**

Feed connector for weight adapter assembly (nipple + bushing + nut + copper washer)

EQUIPMENT FOR CHECKING PUMPS AND INJECTORS



DL-K7 (DL-CR30161)

**Fuel jet catcher (cola receiver) for
nozzle nozzles (nozzle on the nozzle) Ø7 mm**

Contents of delivery:

cola receiver - 1 pc, fitting - 1 pc, fixing screw - 1 pc.



DL-K9 (DL-CR30505)

**Fuel jet catcher (cola receiver) for
nozzle nozzles (nozzle on the nozzle) Ø9 mm**

Contents of delivery:

cola receiver - 1 pc, fitting - 1 pc, fixing screw - 1 pc.



DL-UNI30156 (DL-PG)

Defoamer Liquid

Contents of delivery:

defoamer - 1 pc, fitting - 1 pc.



DL-MOK 6MM x 6MM

Quick coupling with return valve

Connection holes Ø 6mm X 6mm

EQUIPMENT FOR CHECKING PUMPS AND INJECTORS

**DL-CR10028 DL-KD (CR40)**

Bracket for Rail DL-CR30181KIT, DL-CR30522KIT
from CR accessories

**DL-ASB (CR23)**

Adapter cup for Bosch
injectors to frame
CR-equipment

**DL-ASD (CR24)**

Adapter cup for Delphi
injectors to frame
CR-equipment

**DL-RF (CR39)**

Frame - nozzle holder

**DL-CR10015 DL-RFJ**

Nozzle holder frame with cups (DL-UNI50342) for
sprayers 7 mm (4 pcs.) and clamping sleeves

DL-UNI31019 inner Ø 17 mm – 4pcs

DL-UNI31020 inner Ø 18,9 mm – 1pc

DL-UNI31021 inner Ø 19,2 mm – 1pc

DL-UNI31022 inner Ø 21 mm – 1pc

DL-UNI31031 inner Ø 21,4 mm – 1pc

EQUIPMENT FOR CHECKING PUMPS AND INJECTORS

DL-UNI31011

Set of split sleeves (basic)
to install injectors



DL-UNI31019	inner Ø 17 mm
DL-UNI31020	inner Ø 18,9 mm
DL-UNI31021	inner Ø 19,2 mm
DL-UNI31022	inner Ø 21 mm
DL-UNI31031	inner Ø 21,4 mm

Attention! All bushings are also sold separately.

DL-UNI31013

Split sleeve kit for
nozzle settings



DL-UNI31015	inner Ø 24 mm
DL-UNI31016	inner Ø 25 mm
DL-UNI31017	inner Ø 26 mm

Attention! All bushings are also sold separately.

**DL-UNI50342**

Cup-clamp for
nozzles Ø7 mm

**DL-UNI50343**

Cup-clamp for
nozzles Ø9 mm

EQUIPMENT FOR CHECKING PUMPS AND INJECTORS



DL-CR50302

Nozzle holder frame for one channel

Included in the package:

DL-UNI31019	inner Ø 17 mm – 1pc*
DL-UNI31020	inner Ø 18,9 mm – 1pc
DL-UNI31021	inner Ø 19,2 mm – 1pc
DL-UNI31022	inner Ø 21 mm – 1pc
DL-UNI31031	inner Ø 21,4 mm – 1pc
DL-SZR	cup-clamp sprayer 7 mm *

* mounted on a frame



DL-UNI21032

holder bracket
injectors per channel



Nozzle holder frame for one channel
with bracket assembly

Installation example for nozzle holder, brackets and accumulators pressure on the stand plate

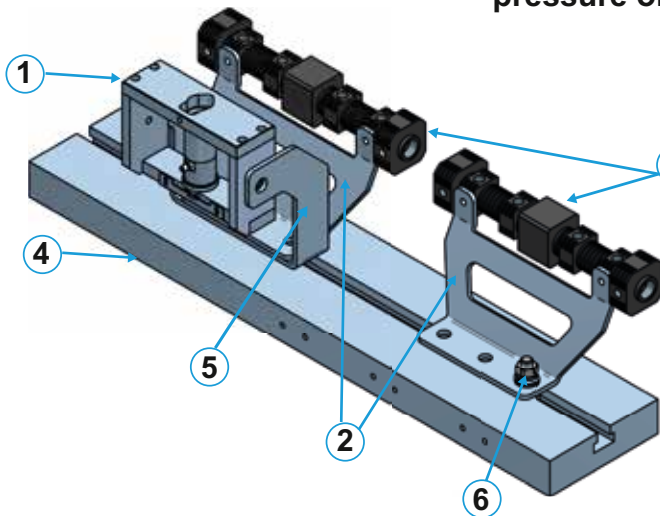

- 1 **DL-CR50302** Nozzle holder frame per channel
- 2 **DL-CR10028** Bracket for RailDL-CR30181KIT, DL-CR30522KIT, DL-CR31053KIT
- 3 Pressure accumulator: DL-CR30181KIT, DL-CR30522KIT, DL-CR31053KIT
- 4 **DL-SPN30535** Stand mounting plate
- 5 **DL-UNI21032** holder bracket injectors per channel
- 6 **DL-UNI30089** T-Slot Bolt

EQUIPMENT FOR CHECKING PUMPS AND INJECTORS

**DL-CR10025 DL-KDRJ****Bracket - injector frame holder****Contents of delivery:**

- Frame 1 pc.
- Intermediate bracket 2 pcs.
- Protective glass bracket 2 pcs. (can be welded to the frame)
- Bracket holder of an additional pressure accumulator. (can be welded to the frame)

**DL-CR10026****Drive Side Fixing Bracket pressure (Rail)**

The bracket is fixed with M8x25 bolts to the carrier plate in the test compartment of the stand, or to a structure that performs a similar function.

Used to mount pressure accumulators (Rail): DL-CR30181, DL-CR30522 and DL-CR31053.

Attention! Bolts and nuts are not included in the scope of delivery!

**DL-CR10027****Bracket for pressure accumulator (Rail)****Suitable for the following pressure accumulators:**

DL-CR30181KIT for 2 pressure regulators

DL-CR30522KIT for 3 pressure regulators

DL-CR31053KIT rail with cooling for 3 pressure regulators

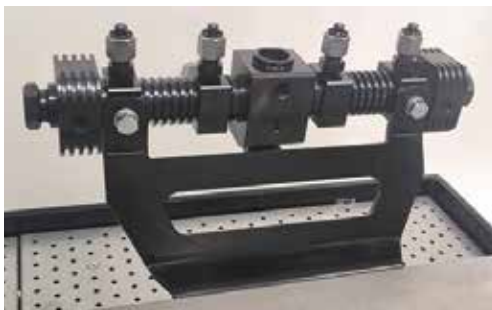

Some drives can be installed from various vehicles

It is installed regularly on stands CR-TEST 4E, CR-TEST-2P, on stands of the SPF series manufactured by Dieselland.

For installation on other stands, it is necessary to make two M10 threaded holes on the side of the plate in a convenient place.

EQUIPMENT FOR CHECKING PUMPS AND INJECTORS

**DL-CR10029**

Bracket for pressure accumulator (Rail)

Suitable for the following pressure accumulators:

DL-CR30181KIT or 2 pressure regulators

DL-CR30522KIT for 3 pressure regulators

DL-CR31053KIT rail with cooling for 3 pressure regulators

Some drives can be installed from various vehicles

It is established on any stands.

For installation, it is necessary to fix the bracket with one or two bolts on top of the stand plate. One or two bolts are preliminarily installed in the T-slot of the plate.

The number of bolts is determined independently or depending on the location of the bracket. For example, with a longitudinal installation on the stand plate, it is possible to fix the bracket with 1-2 bolts, and with a transverse arrangement, fastening is possible with only one bolt. The bracket is put on the bolts through the holes and the bracket is fixed to the plate with nuts.



ATTENTION!

Bolts and nuts are not included in the scope of delivery!

**DL-CR10006**

Protective glass from polycarbonate 6 mm thick.

Protective glass is mounted on brackets **DL-CR10011** or **DL-CR-10025**

Contents of delivery:

Protective glass - 1 pc. U-shaped handle - 2 pcs.

**DL-CR10010**

Protective glass from polycarbonate 8 mm thick.

Protective glass is mounted on brackets **DL-CR10011** or **DL-CR-10025**

Contents of delivery:

Protective glass - 1 pc. U-shaped handle - 2 pcs.

**DL-CR10011**

A set of brackets for installing a protective fences

Installed with protective railing polycarbonate **DL-CR10006** and **DL-CR10010** directly on the stand plate.

Contents of delivery:

Protection mounting bracket - 2 pcs.

Nut "lamb" for fixing the protection - 2 pcs.

EQUIPMENT FOR CHECKING PUMPS AND INJECTORS

DL-CR30181KIT (for 2 regulators)

Pressure accumulator (Rail) for checking nozzles and CR pumps on the stand



The rail has holes for:

- pressure sensor connection M18x1.5
- pressure regulator connections M24x1.5 (2 holes)
- backflow connections M12x1.5 (4 holes)
- liquid supply to rail M14x1.5 (2 holes)
- exit of liquid from rail M14x1.5 (4 holes)
- connection of safety valve M20x1.5
- pressure relief in case of its excess \varnothing 3mm. or M5
- M6 pressure gauge mounts (2 blind holes)
- M8 rail attachments (2 or 4 blind holes).

Contents of delivery:

1. **DL-CR30181** ramp (Rail) - 1 pc,
2. **DL-UNI30218** fitting M14x1.5 in a set with washers-gaskets SHP15084 - 6 pcs,
3. **DL-UNI50271** plug with internal thread M14x1.5 - 5 pcs,
4. **DL-UNI30497** plug instead of pressure regulator - 2 pcs.,
5. **DL-CR30493** plug instead of safety valve M20x1.5 - 1 pc.
6. **DL-SHP15084** washer-gasket for pressure sensor
7. **DL-UNI30162** M18x1.5 plug instead of pressure sensor

DL- CR30522KIT (for 3 regulators)

Pressure accumulator (Rail) for testing pumps CP1, CP2, CP3, CP4, Delphi, Denso and CR injectors on the bench



The rail has holes for:

- pressure sensor connection M18x1.5
- pressure regulator connections M24x1.5 (3 holes)
- backflow connections M12x1.5 (5 holes)
- liquid supply to rail M14x1.5 (2 holes)
- liquid outlet from rail M14x1.5 (2 holes)
- connection of safety valve M20x1.5
- pressure relief in case of its excess \varnothing 3mm. or M12x1.5
- M6 pressure gauge mounts (2 blind holes)
- M8 rail attachments (2 or 4 blind holes).

Contents of delivery:

1. **DL- CR30522** ramp (Rail) - 1 pc,
2. **DL-UNI30218** fitting M14x1.5 in a set with washers-gaskets SHP15084 - 6 pcs,
3. **DL-UNI50271** plug with internal thread M14x1.5 - 5 pcs,
4. **DL-UNI30497** plug instead of pressure regulator - 3 pcs.,
5. **DL-CR30493** plug instead of safety valve M20x1.5 - 1 pc.
6. **DL-SHP15084** washer-gasket for pressure sensor
7. **DL-UNI30162** M18x1.5 plug instead of pressure sensor

EQUIPMENT FOR CHECKING PUMPS AND INJECTORS

**DL-CR30777KIT**

Pressure accumulator (Rail) for testing CR injectors, pumps BOSCH CP1, CP2, CP3, CP4, various types High pressure fuel pump Delphi, Denso, Siemens and other CR pumps. (Mounting holes 90° away from fittings.)

The rail has threaded holes for:

- pressure sensor connection M18x1.5
- pressure regulator connections M24x1.5
- backflow connections 1 hole M12x1.5
- supply and exit of liquid from the rail 2 holes for fittings M14x1.5
- mounting rail M8 (2 blind holes)
- additional fitting made in one whole with rail M14x1.5

Contents of delivery:

1. **DL-CR30777** ramp (Rail) - 1 pc.
2. **DL-UNI30218** fitting M14x1.5 in a set with washers-gaskets SHP15084 - 2 pcs.
3. **DL-UNI30497** plug instead of pressure regulator - 1 pc.
4. **DL-UNI50271** plug with internal thread M14x1.5 - 2 pcs.

**DL-CR30180KIT**

Pressure accumulator (Rail) for testing pumps CP1, CP2, CP3, CP4, Delphi, Denso and CR injectors

The rail has threaded holes for:

- pressure regulator connections M24x1.5
- backflow connections 1 hole. M12x1.5
- supply and exit of liquid from the rail 2 holes. for fittings M14x1.5
- M8 rail attachments (2 blind holes)
- nipple M14x1.5

Комплект поставки:

1. **DL-CR30180** ramp (Rail) - 1 pc.
2. **DL-UNI30218** fitting M14x1.5 in a set with washers-gaskets SHP15084 - 2 pcs.
3. **DL-UNI30497** plug instead of pressure regulator - 1 pc.
4. **DL-UNI50271** plug with internal thread M14x1.5 - 2 pcs.

EQUIPMENT FOR CHECKING PUMPS AND INJECTORS

DL-CR30526KIT

Pressure accumulator (Rail) for testing pumps CP1, CP2, CP3, CP4, Delphi, Denso and CR injectors below the pressure sensor.
(Mounting holes 180° from fittings.)

**The rail has threaded holes for:**

- pressure sensor connection M18x1.5
- pressure regulator connections M24x1.5
- backflow connections 1 hole M12x1.5
- supply and exit of liquid from the rail 2 holes for fittings M14x1.5
- mounting rail M8 (2 blind holes)

Contents of delivery:

1. **DL-CR30526** ramp (Rail) - 1 pc.
2. **DL-UNI30218** fitting M14x1.5 in a set with washers-gaskets SHP15084 - 2 pcs.
3. **DL-UNI30497** plug instead of pressure regulator - 1 pc.
4. **DL-UNI50271** plug with internal thread M14x1.5 - 2 pcs.

DL-CR30878KIT

Pressure accumulator (Rail) for testing pumps CP1, CP2, CP3, CP4, Delphi, Denso and CR injectors below the pressure sensor.
(Mounting holes 90° away from fittings.)

**The rail has threaded holes for:**

- pressure sensor connection M18x1.5
- pressure regulator connections M24x1.5
- backflow connections 1 hole M12x1.5
- supply and exit of liquid from the rail 2 holes for fittings M14x1.5
- mounting rail M8 (2 blind holes)

Contents of delivery:

1. **DL-CR30878** ramp (Rail) - 1 pc.
2. **DL-UNI30218** fitting M14x1.5 in a set with washers-gaskets SHP15084 - 2 pcs.
3. **DL-UNI30497** plug instead of pressure regulator - 1 pc.
4. **DL-UNI50271** plug with internal thread M14x1.5 - 2 pcs.

EQUIPMENT FOR CHECKING PUMPS AND INJECTORS

DL-CR30479KIT

Pressure accumulator (Rail) for testing pumps and CR injectors for pressure regulator and safety valve.



The rail has threaded holes for:

- connection of the pressure regulator M24x1.5 (1 hole)
- backflow connections M12x1.5 (1 hole)
- supply and exit of liquid from the rail M14x1.5 (3 holes)
- connection of safety valve M20x1.5
- pressure relief if it is exceeded M12x1.5
- M6 pressure gauge mounts (2 blind holes)
- M8 rail attachments (4 blind holes)

ATTENTION!

Pressure regulators and pressure sensor included supplies are not included!

The pressure sensor is connected through the fitting-adaptor M14xM18

Contents of delivery:

1. **DL-CR30479** Ramp (Rail) - 1 piece
2. **DL-UNI30218** Fitting M14x1.5 complete with washers-gaskets SHP15084 - 3 pcs.
3. **DL-UNI30497** Plug instead of pressure regulator - 1 pc.
4. **DL-UNI50271** Plug with internal thread M14x1.5 - 3 pcs.
5. **DL-UNI30796** Special fitting-adaptor for the sensor pressure M14xM18 - 1 pc.
6. **DL-UNI30493** Plug instead of safety valve - 1 pc.
7. **22-HS-06** M12x1.5 bolt-banjo fitting for connection backflow, hole next to the pressure regulator - 1 pc.
8. **22-RSN-06** Banjo fitting Ø12mm x 8mm (herringbone) for connection back drain - 1 pc.
9. **D-GM1537AN** Rubber-metal washer Ø12mm, installed on the plug DL-UNI30636, banjo bolt 22-HS-06 and similar parts providing connection tightness - 2 pcs.

*Instead of a banjo fitting Ø12mm x 8mm **22-RSN-06**, an M12" x 8 fitting can be used **34-R0608** M12 x 1.5 allowing backflow through Teflon tube **P1006**

**DL-CR50269**

**Drive holder bracket
Pressure (RAIL) DL-CR30180**

Also suitable for pressure accumulators
DL-CR30479, DL-CR30526, DL-CR30878, DL-CR30777

**DL-CR50268**

**Drive holder bracket
Pressure (RAIL) DL-CR30188**

EQUIPMENT FOR CHECKING PUMPS AND INJECTORS

**DL-CR30188KIT**

Pressure accumulator (Rail) for testing pumps CP1, CP2, CP3, CP4, Delphi, Denso and CR injectors. Rail has channels cooling for improved thermal stability during testing and testing of nozzles and pumps of the Common-Rail system.

The rail has threaded holes for:

- pressure sensor connection M18x1.5
- pressure regulator connections
- backflow connections 1 hole. M12x1.5
- fitting for connecting a hose or tube for rail cooling Ø8mm
- supply and exit of liquid from the rail 3 holes. for fittings M14x1.5
- fixings, 4 blind holes. M8.

**Contents of delivery:**

1. **DL-CR30188** ramna (Rail) – 1 шт.
2. **DL-UNI30218** fitting M14x1.5 complete with washers-gaskets SHP15084 - 3 pcs.
3. **DL-UNI30497** plug instead of pressure regulator - 1 pc.
4. **DL-UNI50271** plug with internal thread M14x1.5 - 2 pcs.
5. **DL-UNI30293** fitting 1/8"x8 (herringbone) for connecting hoses cooling - 2 pcs.
6. **DL-UNI30162** plug instead of pressure sensor M18x1.5 - 1 pc.

DL-CR31068KIT

Pressure accumulator (Rail) for testing pumps CP1, CP2, CP3, CP4, Delphi, Denso and CR injectors. The rail has cooling channels for improved thermal stability in testing and testing nozzles and pumps of the Common-Rail system.

**The rail has threaded holes for:**

- pressure sensor connection M18x1.5
- pressure regulator connections
- backflow connections 1 hole M12x1.5
- safety valve
- fitting for connecting a hose or tube for cooling rail diameter 8mm
- supply and exit of liquid from the rail 3 holes for fittings M14x1.5
- fixings, 4 blind holes M8

Contents of delivery:

1. **DL-CR31068** ramp (Rail) - 1 pc.
2. **DL-UNI30218** fitting M14x1.5 in a set with washers-gaskets SHP15084 - 3 pcs.
3. **DL-UNI30497** plug instead of pressure regulator - 1 pc.
4. **DL-UNI50271** plug with internal thread M14x1.5 - 1 pc.
5. **DL-UNI30293** fitting 1/8"x8 (herringbone) for connecting hoses cooling - 2 pcs.
6. **DL-UNI30162** plug instead of pressure sensor M18x1.5 - 1 pc.

EQUIPMENT FOR CHECKING PUMPS AND INJECTORS

DL-CR31053KIT



Pressure accumulator for 3 regulators with cooling for testing injection pump CR

Contents of delivery:

1. **DL-CR31053** ramp (Rail) - 1 pc.
2. **DL-UNI30151** Plug instead of pressure regulator - 3 pcs.
3. **DL-UNI30162** Plug M18x1.5 instead of pressure sensor - 1 pc.
4. **34-R0608M12X1.5** Fitting M12 "x8 for backflow - 3 pcs.
5. **34-RL0408** Fitting-angle 8mmx8mm for backflow - 2 pcs.
6. **34-RL0508** Tee fitting 8mmx8mmx8mm for backflow - 1 pc.
7. **P1006** Teflon tube d.8mmx180mm - 2 pcs.
8. **22-HS-06** M12x1.5 bolt-banjo fitting for hose connection return drain - 1 pc.
9. **22-RSN-06** Banjo fitting Ø12mmx8mm (herringbone) for backflow hose connections - 1 pc.
10. **D-GM1537AN** Rubber-metal washer Ø12mm - 2pcs
11. **DL-UNI30636** Plugs in backflow channels - 2 pcs.
12. **DL-UNI30293** 1/8"x8 (herringbone) fitting for connecting hoses cooling - 2 pcs.
13. **DL-UNI30218** High pressure fitting M14(1.5)xM14(1.5) in a set with washers-gaskets SHP15084 - 2 pcs.
14. **DL-UNI50271** Plug for high pressure fitting - 2 pcs.
15. **DL-SHP15084** Gasket for pressure sensor - 1 pc.

DL-UNI30828KIT



high pressure Bosch filter adapter for testing pumps CP2-CP4.

The adapter is mounted in one of the 2 holes M14x1.5 in Rail. Used with pressure accumulators (rail) **DL-CR31053** , **DL-CR30181** and **DL-CR30522**

The adapter has threaded holes:

- for a filter for a special fitting M18x1.5 (1 hole)
- for liquid supply M14x1.5 (2 holes from above)
- for connecting a pressure sensor M18x1.5 (1 hole)
- for connecting a safety valve M20x1.5 (1 hole)
- to relieve pressure in case of its excess M5 (1 hole)

Contents of delivery:

1. **DL-UNI30828** Adapter housing - 1 pc,
2. **DL-UNF21100** High pressure filter - 1 pc.,
3. **DL-UNI30871** Special fitting for high pressure filter M14xM18 - 1 pc.,
4. **DL-UNI30218** Fitting M14x1.5 -2 pcs.,
5. **DL-SHP15084** Sealing washer - 3 pcs.,
6. **DL-UNI50271** Plug M14x1.5 -1 pc.,
7. **34-RL01006M5** Straight fitting Ø 6mm x M5 or 34-RL3106M5 elbow fitting Ø 6mm x M5.,
8. **DL-SHP15084** Gasket for pressure sensor - 1 pc.



EQUIPMENT FOR CHECKING PUMPS AND INJECTORS

**DL-CR31049KIT****Pressure accumulator (rail) for checking injectors and pumps with cooling (for 3 pressure regulators)**

Pressure accumulator (Rail) for testing pumps CP1, CP2, CP3, CP4, Delphi, Denso and CR injectors. The rail has cooling channels for improved thermal stabilization during testing and testing nozzles and pumps of the Common-Rail system.

Contents of delivery:

1. **DL-CR31049** Pressure accumulator for 3 pressure regulators
2. **DL-CR30497** Plug (M24x1.5mm) instead of regulator pressure - 2 pcs.
3. **DL-UNI30162** Plug (M18x1.5mm) instead of pressure sensor - 1 pc
4. **DL-UNI30056** Cooling fitting (1/2"x8mm) - 2 pcs.
5. **DL-UNI30020** Fitting (1/4 "x8mm) outlet of the return drain from the pressure regulator - 3 pcs.
6. **DL-UNI31478** Fitting (M18x1.5mm X M14x1.5mm) for high pressure tube - 3 pcs.
7. **DL-UNI50271** Plug for fitting DL-UNI31478 - 1 pc.
8. **DL-UNI30203** Plugs (1/8") for cooling channels - 4 pcs.
9. **DL-UNI30635** Plug (M12x1.5) for rubber-metal washer - 1 pc.



ATTENTION! Regulators and pressure sensor not included!

DL-UNI21042**Pressure accumulator bracket****DL-CR31514 Drain rail**

Designed to work with the main pressure accumulator (rail) with installed 3 taxiways. This drain rail facilitates switching drain hoses.

Normally, the pressure accumulator **DL-CR31049** is drained from each pressure regulator (RD). When using this rail drain is made from one fitting.

**DL-CR31528 Drain rail**

Designed to work with the main pressure accumulator (rail) with installed 2 taxiways. This drain rail facilitates switching drain hoses.

Normally, the pressure accumulator **DL-CR31049** is drained from each pressure regulator (RD). When using this rail drain is made from one fitting.

EQUIPMENT FOR CHECKING PUMPS AND INJECTORS

**DL-CR31257KIT**

Pressure accumulator (rail) for checking injectors and pumps with cooling (for 2 pressure regulators)

The rail has threaded holes for:

- pressure sensor connection (M18x1.5)
- pressure regulator connection (2 holes M24x1.5mm)
- backflow connections and plugs (4 holes 1/8")
- a fitting for connecting a hose or tube for rail cooling and plugs (5 holes 1/4")
- supply and output of high pressure fluid from the rail (2 holes M24x1.5mm)
- high-pressure fluid inlet and outlet from the rail on the side (2 holes M14x1.5mm)
- rail mounting (4 blind holes M8)

Contents of delivery:

1. **DL-CR31257** Pressure accumulator for 2 pressure regulators
2. **DL-CR30497** Plug (M24x1.5mm) instead of pressure regulator (1 pc.)
3. **DL-UNI30162** Plug (M18x1.5mm) instead of pressure sensor (1 pc.)
4. **DL-UNI30020** Fitting (1/4"x8mm) for inlet and outlet of TJ for cooling (2 pcs.)
5. **DL-UNI30202** Plug (1/4") cooling channel (3 pcs.)
5. **DL-UNI30293** Fitting (1/8"x8mm) for backflow outlet from RD (1 pc.)
6. **DL-UNI30203** Plug (1/8") for the rubber gasket in the channel back drain (1 pc.)
7. **DL-UNI31082** Plug (1/8") slotted in the backflow channel with rail ends (2 pcs.)
6. **DL-UNI31041** Fitting (M24x1.5mm X M14x1.5mm) for TVD (1 pc.)
7. **DL-UNI31039** Plug (M24x1.5mm) for HP channel (1 pc.)
8. **DL-UNI31535** Fitting (M14x1.5 X M14x1.5mm) for TVD (2 pcs.)
9. **DL-UNI50271** Plug for fitting DL-UNI31535 (1 pc.)

ATTENTION!

Regulators and pressure sensor not included!

**DL-UNI21041**

Pressure accumulator bracket

EQUIPMENT FOR CHECKING PUMPS AND INJECTORS

ANGLE ADAPTERS

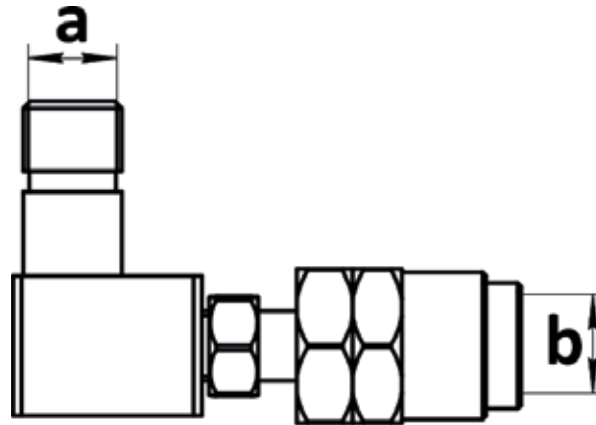

Article	a (mm)	b (mm)
DL-UNI50278	M14 x 1,5	M14 x 1,5
DL-UNI50279	M14 x 1,5	M12 x 1,5
DL-UNI50280	M14 x 1,5	M16 x 1
DL-UNI50281	M14 x 1,5	M16 x 1,5
DL-UNI50282	M14 x 1,5	M18 x 1,5

A photograph of a black metal angle adapter, showing a 90-degree bend. The vertical part has a threaded end, and the horizontal part has a flared end. The adapter is shown against a white background.

DL-UNI50283	M12 x 1,5	M14 x 1,5
DL-UNI50284	M12 x 1,5	M12 x 1,5
DL-UNI50285	M12 x 1,5	M16x1
DL-UNI50286	M12 x 1,5	M16x1,5
DL-UNI50287	M12 x 1,5	M18 x 1,5

A photograph of a black metal angle adapter, showing a 90-degree bend. The vertical part has a threaded end, and the horizontal part has a flared end. The adapter is shown against a white background.

EQUIPMENT FOR CHECKING PUMPS AND INJECTORS

ADAPTERS STRAIGHT

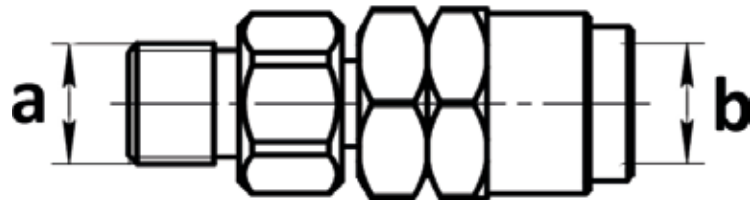

Article	a (mm)	b (mm)
DL-UNI50288	M14 x 1,5	M14 x 1,5
DL-UNI50289	M14 x 1,5	M12 x 1,5
DL-UNI50290	M14 x 1,5	M16 x 1
DL-UNI50291	M14 x 1,5	M16 x 1,5
DL-UNI50292	M14 x 1,5	M18 x 1,5



A photograph of a straight adapter, showing the component from a perspective view. The adapter is black and has a threaded section on the left, followed by a hexagonal section, a central section with a hexagonal bore, and a final section with a hexagonal end.

DL-UNI50293	M12 x 1,5	M14 x 1,5
DL-UNI50294	M12 x 1,5	M12 x 1,5
DL-UNI50295	M12 x 1,5	M16 x 1
DL-UNI50296	M12 x 1,5	M16 x 1,5
DL-UNI50297	M12 x 1,5	M18 x 1,5



A photograph of a straight adapter, showing the component from a perspective view. The adapter is black and has a threaded section on the left, followed by a hexagonal section, a central section with a hexagonal bore, and a final section with a hexagonal end.

EQUIPMENT FOR CHECKING PUMPS AND INJECTORS

ANGLE ADAPTERS WITH INTERCHANGEABLE NUT

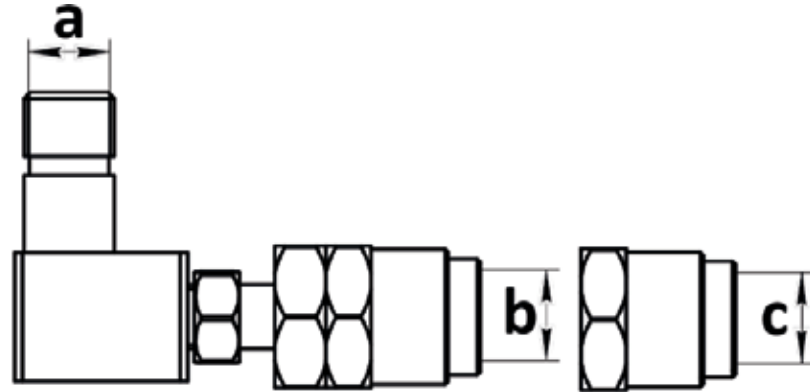

Article	a (mm)	b (mm)	c (mm)
DL-UNI50084	M14 x 1,5	M12 x 1,5	M14 x 1,5
DL-UNI50088	M12 x 1,5	M12 x 1,5	M14 x 1,5



ADAPTERS STRAIGHT WITH INTERCHANGEABLE NUT

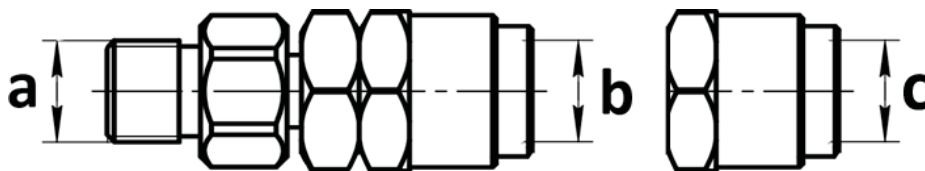

Article	a (mm)	b (mm)	c (mm)
DL-UNI50083	M14x1,5	M12x1,5	M14x1,5
DL-UNI50087	M12x1,5	M12x1,5	M14x1,5



EQUIPMENT FOR CHECKING PUMPS AND INJECTORS



DL-UNI30980

Replaceable nut from M16x1.0 to M18x1.5
for injector CR Bosch 0445120303 (MB)



DL-UNI30981

Replacement nut from M16x1.5 to M18x1.5 for pumps
CR Bosch CP4 0445010637, 0445010506, 0445010512.



DL-UNI31398

Replaceable nut from M18x1.5 to M18x1.5 for connection
to pressure accumulator BOSCH EPS-815 / EPS-708



DL-UNI50175

Adapter straight long
M14xM12 (pitch 1.5mm) with inner cone

Used for installation on a pressure accumulator

*Can be installed for testing
BOSCH PIEZO injectors.*



EQUIPMENT FOR CHECKING PUMPS AND INJECTORS

**DL-UNI50055**

Thread adapter
M14x1.5mm to M12x1.5mm

Contents of delivery
adapter - 1 pc.

**DL-UNI50056**

Thread adapter
M12x1.5mm to M14x1.5mm

Contents of delivery
adapter - 1 pc.

**DL-UNI50276**

Thread adapter
M14x1.5mm to M14x1.5mm

Contents of delivery
adapter - 1 pc.

DL-CR50121

High pressure filter adapter DL-UNF21100
Mounted instead of a conventional fitting in the drive
pressure (Rail) DL-CR30479, DL-CR30180, DL-CR30181,
DL-CR30188, DL-CR30522, DL-CR30526

Contents of delivery:
adapter - 1 pc., adapter body with M14x1.5 thread - 1 pc.

ВНИМАНИЕ!

Фильтр высокого давления DL-UNF21100 в комплект поставки не входит и заказывается отдельно!

**DL-UNI30650**

Safety valve adapter for
pressure accumulator (Rail) DL-CR30188, DL-CR30180

Contents of delivery:
adapter - 1 pc.

**DL-UNI30796**

Adapter from M14 to M18 thread for installation
pressure sensor in pressure accumulators
DL-CR30479, DL-CR30180

Contents of delivery:
adapter - 1 pc.

EQUIPMENT FOR CHECKING PUMPS AND INJECTORS

**DL-CR14014**

**Angle adapter with thread
M14x1.5mm to M14x1.5mm**

Convenient when connected to pumps
high pressure, pressure accumulators
(rails) and nozzles.

Delivery set: adapter 1 pc.

**DL-CR14012**

**Angle adapter with thread
M14x1.5mm to M12x1.5mm**

Convenient when connected to pumps
high pressure, pressure accumulators
(rails) and nozzles.

Delivery set: adapter 1 pc.



EQUIPMENT FOR CHECKING PUMPS AND INJECTORS

**DL-UNI30287**

Adapter with internal thread G1/2" for pressure gauge at 2000 bar. Has a connecting M14x1.5mm thread with 60° cone for tube high pressure (HPT)

Contents of delivery:
adapter - 1 pc.

**DL-UNI30508**

Adapter with internal thread M20x1.5mm for pressure gauge at 2500 bar. Has a connecting M14x1.5mm thread with 60° cone for tube high pressure (HPT).

Contents of delivery:
adapter - 1 pc.

**DL-SM**

Gasket for pressure gauge

**DL-CR14P2000**

Pressure gauge 2000 bar

**DL-CR14P2500**

Pressure gauge 2500 bar

EQUIPMENT FOR CHECKING PUMPS AND INJECTORS



DL-KM2000

**Pressure gauge bracket for 2000bar.
For rail DL-CR30181 and DL-CR30522**

Contents of delivery:

- bracket
- clamping bar
- M6x60 bolt, nuts, washers - 2 sets
- M6x45 bolt, washers - 2 sets



DL-KM3000

**Pressure gauge bracket 2000bar
for installation on a stand plate.**

Contents of delivery:

- bracket
- Profile bolt with nut, washer and grommet
- clamping bar
- M6X60mm bolt with nut, washer and grommet – 2 sets



DL-KM2500

**Pressure gauge bracket for 2500bar.
For rail DL-CR30181 and DL-CR30522**

Contents of delivery:

- main bracket
- pressure gauge mounting ring
- M6x45 bolt, washers - 2 sets
- M6x30 bolt, washers - 2 sets
- M6x10mm bolt - 3 pcs.



DL-KM3500

**Pressure gauge bracket 2500bar
for installation on a stand plate**

Contents of delivery:

- main bracket
- pressure gauge mounting ring
- Profile bolt with nut, washer and grommet
- M6 x30mm bolt with washer and grommet – 2 sets
- M6x10mm bolt - 3 pcs.

EQUIPMENT FOR CHECKING PUMPS AND INJECTORS

**DL-CR10045**Pressure sensor 150 bar for the compressor
DL-UNI20008**DL-CR10046**Pressure sensor 250 bar for the compressor
DL-UNI20008**DL-CR10058**

Bosch pressure sensor 1500 bar

**DL-CR10059**

Bosch pressure sensor 1500 bar

**DL-CR10060**

Bosch pressure sensor 1500 bar

**DL-CR10050**

Bosch pressure sensor 1800 bar

**DL-CR10061**

Bosch pressure sensor 1800 bar

**DL-CR10052**

Bosch pressure sensor 2200 bar

**DL-CR10053**

Bosch pressure sensor 2400 bar

**DL-CR10062**

Bosch pressure sensor 2400 bar

**DL-CR10063**

Bosch pressure sensor 2400 bar

EQUIPMENT FOR CHECKING PUMPS AND INJECTORS

**DL-CR10051**

Bosch pressure regulator 1800 bar

**DL-CR10064**

Bosch pressure regulator 1800 bar

**DL-CR10065**

Bosch pressure regulator 1800 bar

**DL-CR10054**

Bosch pressure regulator 2200 bar

**DL-CR10055**

Bosch pressure regulator 2700 bar

**DL-CR10056**

Safety valve Bosch 1800 bar

**DL-CR10066**

Safety valve Bosch 1800 bar

**DL-CR10057**

Safety valve Bosch 2400 bar

EQUIPMENT FOR CHECKING PUMPS AND INJECTORS

**DL-MOK**

Coupling adapter with check valve
Ø 6 x Ø 6mm with collet

**DL-CR50120**

Valve for response time (DELPHI)

**DL-CR50136**

Check valve
BOSCH electromagnetic injectors on the stand

**DL-CR50210**

Return pressure valve for testing piezo injectors
SIEMENS at the booth

**DL-CR50177**

Return pressure valve for
Bosch piezo injectors



EQUIPMENT FOR CHECKING PUMPS AND INJECTORS

**DL-CR50204**

Set with pressure gauge for testing back pressure in the injector return BOSCH Piezo.

The test is carried out on the vehicle. The pressure gauge is installed in the device with a hook fixing it over the motor space (eg under the hood).

Using this valve kit backwater **DL-CR50177** possible control the correct operation this valve when testing injectors BOSCH Piezo **on the stand.**



Contents of delivery:

1. **D-12-TV63-016** Pressure gauge 0-16 bar
2. **DL-CR31311** Special adapter for pressure gauge
3. **DL-CR31310** Union with rubber gasket for connection to the trunk back drain in the car.
4. **DL-CR31285** Union with fixing screw for installation in the return connection drain nozzle
5. **34-RL0506** Tee with quick fittings 6mm
6. **34-RL010601** Straight quick-release fitting 1/8x6mm - 2 pcs.
7. **DL-CR50246** Suspended Mounting Bracket
8. **D-P1004** Teflon tube - 100cm

ATTENTION! Valve *DL-CR50177* is not included in the scope of delivery!

EQUIPMENT FOR CHECKING PUMPS AND INJECTORS

**DL-UNI30218**

M14x1.5 x M14x1.5 fitting for pressure accumulator (Rail)

**DL-UNI31498**

M14x1.5 x M12x1.5 fitting for pressure accumulator (Rail)

**DL-CR30493**

Plug with external thread M20 x1.5 instead of safety valve for pressure accumulator (Rail)

**DL-UNI30159**

Plug with external thread M24x1.5 heat-treated instead of pressure regulator for pressure accumulator (Rail)

**DL-UNI30162**

Plug with external thread M18x1.5 instead of pressure sensor for pressure accumulator (Rail)

**DL-UNI30636**

Plug with external thread M12x1.5 for drain hole in the pressure accumulator (Rail)

**DL-UNI30529**

Plug with external thread M14x1.5

**DL-UNI50271 (CR30)**

Plug with internal thread M14x1.5 for fitting **DL-UNI30218** for pressure accumulator (Rail)

**DL-UNI50275**

Plug with internal thread M12x1.5 for fitting **DL-UNI3021** for pressure accumulator (Rail)

EQUIPMENT FOR CHECKING PUMPS AND INJECTORS

**DL-UNI30003**

Fitting M14x1.5 X M14x1.5 60° cone for connecting two high pressure pipes

**DL-UNI31589**

Fitting M14x1.5 X M12x1.5 60° cone for connecting two high pressure pipes

**DL-UNI31592**

Fitting M12x1.5 X M12x1.5 60° cone for connecting two high pressure pipes

**DL-UNI50312**

Set of fittings and plugs for (TVD) fuel lines
high pressure

Contents of delivery:

DL-UNI30003 Tubing adapter

M14x1.5 X M14x1.5mm. Has a cone on both sides for tight fit to the cone of the tube

DL-UNI31589 Tubing adapter

M14x1.5 X M12x1.5mm. Has a cone on both sides for tight fit to the cone of the tube

DL-UNI31592 Tubing adapter

M12x1.5 X M12x1.5mm. Has a cone on both sides for tight fit to the cone of the tube

DL-UNI31590 Plug M12x1,5 cone 60°

DL-UNI31591 Plug M14x1,5 cone 60°

**DL-UNI31591**

M14x1.5 plug 60° cone for high pressure pipe

**DL-UNI31590**

M12x1.5 plug 60° cone for high pressure pipe

EQUIPMENT FOR CHECKING PUMPS AND INJECTORS

**DL-TVD-S (Type 5/4 grey)**

High Pressure Tube
1000x14x14 mm 1800 bar

**DL-TVD-K1000**

High Pressure Tube 1000x14x14 mm
2500 bar

**DL-TVD-K830**

High Pressure Tube 840x14x14 mm
2500 bar

**DL-TVD-K700**

High Pressure Tube 700x14x14 mm
2500 bar

**DL-TVD-G**

High Pressure Tube
650x14x14 mm 2500 Bar

**DL-TVD-M**

High pressure metal tube

DL-TVD-M81412 (800) M14xM12
DL-TVD-M81414 (800) M14xM14
DL-TVD-M61412 (600) M14xM12
DL-TVD-M61414 (600) M14xM14

**DL-TVD**

High Pressure tube for stands and equipment:

TVD31212 (300x12x12), TVD31214 (300x12x14), TVD31414 (300x14x14),
 TVD41212 (400x12x12), TVD41214 (400x12x14), TVD41414 (400x14x14),
 TVD51212 (500x12x12), TVD51214 (500x12x14), TVD51414 (500x14x14),
 TVD61212 (600x12x12), TVD61214 (600x12x14), TVD61414 (600x14x14)

DL-CR50149

**Retrofit kit for CR-Jet stands
for pressure 2400 bar**

**Kit includes:**

1. Plug in Rail - 4 pcs.
2. Plug instead of pressure regulator
3. Pressure sensor 2400 bar
4. Pressure regulator 2400 bar
5. Bracket for rail
6. Tee fitting 1/8" x1.5 - 2 pcs.
7. Fitting quick adapter M12x1.5 - 2 pcs.
8. Corner fittings 8x8 - 2 pcs.
9. Fitting M14x M14 (step 1.5) - 4 pcs.
10. Teflon tube Ø 8mm
11. Rail with cooling
12. Flange Ø 107mm
13. Hose Ø 8mm
14. Banjo 14.5x8 mm, banjo bolt M14x1.5 (for supplying TJ to high-pressure fuel pump)
15. Rubber-metal gasket M14x1.5 - 2 pcs.
16. M14x1.5 fitting for backflow from high pressure fuel pump
17. Rubber-metal gasket 14x1.5
18. Fitting M12x1.5 - 3 pcs. (two for injection pump and one for rail drain)
19. Rubber-metal gasket M12
20. Clamp 13 mm - 3 pcs.
21. High pressure fuel pump

DL-CR50149

**Retrofit kit for CR-Jet stands
for pressure 2400 bar without injection pump**

CRISTINA

CRistina High-quality testing and assembly complex of BOSCH, DENSO and DELPHI Common Rail injectors.

CRistina repair- and testing complex is dedicated to assembling and disassembling Bosch, Denso and Delphi Common Rail injectors according to manufacturer specified steps and mechanical tolerances.

The complex offers the ability to measure relevant mechanical tolerances of the injector parts and electrical characteristics of the electromagnet. The assembly/disassembly steps and critical measurement points are presented by convenient step-by-step instructions descriptions and relevant images of the work process itself.

Available in options:

- CRISTINA-BASE
- CRISTINA-BASE-F
- CRISTINA-FULL
- CRISTINA-PROF
- CRISTINA-PROF-FULL
- CRISTINA-SPECIAL



CRISTINA-BASE

Contents of delivery:

1. **DL-CRN005** Stand for measuring and adjusting injector parameters 1 set
2. **DL-KIP020 or DL-KIP025** Indicator digital measuring head
3. **DL-KIP0023 or DL-KIP0028** Communication device for measuring head
4. **DL-CRN50094** Probe set and adapters
5. **DL-CRN50099** Set of 4 adapters for measuring clearances of injectors BOSCH, DENSO
6. **DL-CRistina** Injector control signal activator "Valve stroke actuator" with kit cables including:
 - Power cable 220V - 1 pc.
 - Main cable for connection to the electromagnet – 1 pc.
 - Adapter cable for light injector – 1 pc.
 - Adapter cable for cargo injector – 1 pc.
7. CRistina Software
8. **DL-PASSCRistina** Passport (technical description, instruction manual)

NOTE: Dedicated workbench table is not included.



CRISTINA-BASE-F**Contents of delivery:**

1. **DL-CRN005** Stand for measuring and adjusting injector parameters 1 set
2. **DL-ST01** Clamp for disassembling and assembling nozzle elements and measuring its parameters.
3. **DL-KIP020 or DL-KIP025** Indicator digital measuring head
4. **DL-KIP0023 or DL-KIP0028** Communication device for measuring head
5. **DL-CRN50094** Probe set and adapters
6. **DL-CRN50099** Set of 4 adapters for measuring clearances of injectors BOSCH, DENSO
7. **DL-CRistina** Injector control signal activator in large case with a set of cables including:
 - Power cable 220V - 1 pc.
 - Main cable for connection to the electromagnet – 1 pc.
 - Adapter cable for light injector – 1 pc.
 - Adapter cable for cargo injector – 1 pc.
8. PC with monitor, keyboard
9. CRistina Software
10. **DL-PASSCRistina** Passport (technical description, operating instructions)

NOTE: Dedicated workbench table is not included.



CRISTINA-FULL**Contents of delivery:**

1. **DL-CRN005** Stand for measuring and adjusting injector parameters 1 set
2. **DL-KIP020 or DL-KIP025** Indicator digital measuring head
3. **DL-KIP0023 or DL-KIP0028** Communication device for measuring head
4. **DL-CRN50094** Probe set and adapters
5. **DL-CRN50099** Set of 4 adapters for measuring clearances of injectors BOSCH, DENSO
6. **DL-CRistina** Injector control signal activator "Valve stroke actuator" with kit cables including:
 - Power cable 220V - 1 pc.
 - Main cable for connection to the electromagnet – 1 pc.
 - Adapter cable for light injector – 1 pc.
 - Adapter cable for cargo injector – 1 pc.
7. PC with monitor, keyboard
8. CRistina Software
9. **DL-PASSCRistina** Passport (technical description, operating instructions)
10. **DL-125** Vice L=250mm
11. **CR-NEXT-ST01** Special table-workbench with two drawers included:
 - Table with two drawers
 - Perforated wall for tool placement
 - Lighting ramp with two holders
 - PC shelf
 - Shelf for signal generator

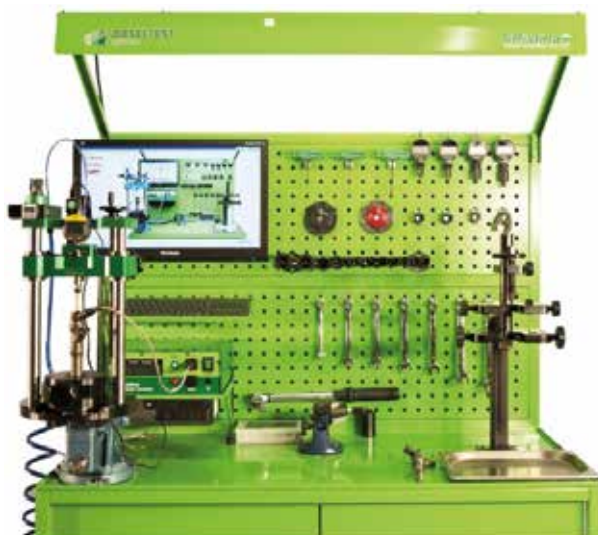

or



CRISTINA-PROF**Contents of delivery:**

1. **DL-CRN005** Stand for measuring and adjusting injector parameters 1 set
2. **DL-KIP020 or DL-KIP025** Indicator digital measuring head
3. **DL-KIP0023 or DL-KIP0028** Communication device for measuring head
4. **DL-CRN50094** Probe set and adapters
5. **DL-CRN50099** Set of 4 adapters for measuring clearances of injectors BOSCH, DENSO
6. **DL-CRistina** Injector control signal activator "Valve stroke actuator" with kit cables including:
 - Power cable 220V - 1 pc.
 - Main cable for connection to the electromagnet – 1 pc.
 - Adapter cable for light injector – 1 pc.
 - Adapter cable for cargo injector – 1 pc.
7. CRistina Software
8. **DL-PASSCRistina** Passport (technical description, operating instructions)
9. **D-MV200UM** Electron microscope
10. **D-07147122** Torque wrench 1/2" 20-100 Nm
11. **DL-CR50104** Support ring set
12. **DL-UNI30390** Wrench for removing the solenoid for CR injectors with a 30 mm hexagon.
13. **DL-UNI30389** Wrench for removing the solenoid for CR injectors with a 29 mm hexagon.
14. **DL-UNI30435** Wrench for removing the solenoid of CR injectors with a 28 mm dodecahedron.
15. **DL-UNI30434** Wrench for removing the solenoid of CR injectors with a 27 mm dodecahedron.
16. **DL-UNI50046** 3 prong wrench for removing the nut in the electronic part of DENSO injectors.
17. **DL-UNI30545** Wrench for removing the nut in the electronic part of Siemens injectors **DL-UNI30545**
18. **DL-UNI50050** A set of wrenches for dismantling the atomizer nut (hexagon 14 mm, 15 mm, 17mm, 19mm, 16mm and 17.5mm octagon and 27mm wrench)
19. **DL-CR30561** Wrench for dismantling the multiplier nut for Bosch CR injectors, hexagon 10 mm.
20. **DL-TORX10** Wrench for removing the nut in the electronic part of Bosch injectors 10 mm.

21. **DL-TORX12** Wrench for removing the nut in the electronic part of Bosch injectors 12 mm.
22. **DL-AP2** Set of 2 anti-magnetic tweezers.
23. **DL-08CR5-244** Adjusting washers 55 pcs.
24. **DL-09CR5-219** Adjusting washers 55 pcs.
25. **DL-11CR5-236** Adjusting washers 55 pcs.
26. **DL-12CR5-230** Adjusting washers 130 pcs.
27. **DL-16CR5-232** Adjusting washers 60 pcs.
28. **DL-18CR5-271** Adjusting washers 55 pcs.
29. **DL-19CR5-273** Adjusting washers 55 pcs.
30. **DL-25CR5-288** Adjusting washers 55 pcs.
31. **DL-28CR5-287** Adjusting washers 110 pcs.

NOTE: Dedicated workbench table is not included.



CRISTINA-PROF-FULL**Contents of delivery:**

1. **DL-CRN005** Stand for measuring and adjusting injector parameters 1 set
2. **DL-KIP020 or DL-KIP025** Indicator digital measuring head
3. **DL-KIP0023 or DL-KIP0028** Communication device for measuring head
4. **DL-CRN50094** Probe set and adapters
5. **DL-CRN50099** Set of 4 adapters for measuring clearances of injectors BOSCH, DENSO
6. **DL-CRistina** Injector control signal activator "Valve stroke actuator" with kit cables including:
 - Power cable 220V - 1 pc.
 - Main cable for connection to the electromagnet – 1 pc.
 - Adapter cable for light injector – 1 pc.
 - Adapter cable for cargo injector – 1 pc.
7. CRistina Software
8. **DL-PASSCRistina** Passport (technical description, operating instructions)
9. **D-MV200UM** Electron microscope
10. **D-07147122** Torque wrench 1/2" 20-100 Nm
11. **DL-CR50104** Support ring set
12. **DL-UNI30390** Wrench for removing the solenoid for CR injectors with a 30 mm hexagon.
13. **DL-UNI30389** Wrench for removing the solenoid for CR injectors with a 29 mm hexagon.
14. **DL-UNI30435** Wrench for removing the solenoid of CR injectors with a 28 mm dodecahedron.
15. **DL-UNI30434** Wrench for removing the solenoid of CR injectors with a 27 mm dodecahedron.
16. **DL-UNI50046** 3 prong wrench for removing the nut in the electronic part of DENSO injectors.
17. **DL-UNI30545** Wrench for removing the nut in the electronic part of Siemens injectors **DL-UNI30545**
18. **DL-UNI50050** A set of wrenches for dismantling the atomizer nut (hexagon 14 mm, 15 mm, 17mm, 19mm, 16mm and 17.5mm octagon and 27mm wrench)
19. **DL-CR30561** Wrench for dismantling the multiplier nut for Bosch CR injectors, hexagon 10 mm.
20. **DL-TORX10** Wrench for removing the nut in the electronic part of Bosch injectors 10 mm.

21. **DL-TORX12** Wrench for removing the nut in the electronic part of Bosch injectors 12 mm.
22. **DL-AP2** Set of 2 anti-magnetic tweezers.
23. **DL-08CR5-244** Adjusting washers 55 pcs.
24. **DL-09CR5-219** Adjusting washers 55 pcs.
25. **DL-11CR5-236** Adjusting washers 55 pcs.
26. **DL-12CR5-230** Adjusting washers 130 pcs.
27. **DL-16CR5-232** Adjusting washers 60 pcs.
28. **DL-18CR5-271** Adjusting washers 55 pcs.
29. **DL-19CR5-273** Adjusting washers 55 pcs.
30. **DL-25CR5-288** Adjusting washers 55 pcs.
31. **DL-28CR5-287** Adjusting washers 110 pcs.
32. **DL-125** Vice L=250 mm
33. **CR-NEXT-ST01** Special table-workbench with two drawers included:
 - Table with two drawers
 - Perforated wall for tool placement
 - Lighting ramp with two holders
 - PC shelf
 - Shelf for signal generator
34. PC with monitor, keyboard
35. **DL-KIP010** Digital measuring head 0.01mm, travel 12.7mm (1pc)
36. **DL-KIP011** Digital measuring heads 0.001mm, travel 12.7mm (2pcs)
37. **DL-KIP012** Digital measuring head 0.001mm, stroke 25.4mm (1pc.)
38. **DL-ST-01** Clamp for disassembly-assembly of injectors.

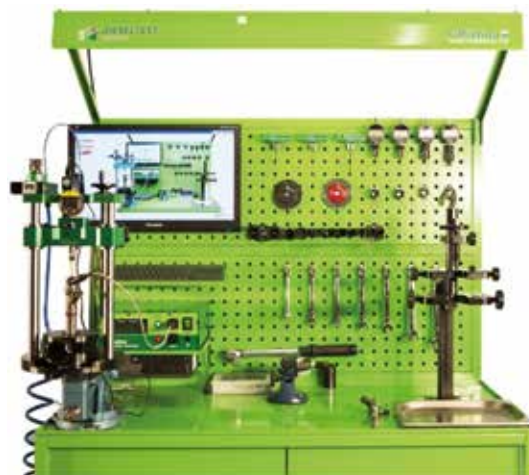

CRISTINA-SPECIAL**Contents of delivery**

1. **DL-CRN005** Stand for measuring and adjusting injector parameters 1 set
2. **DL-KIP020 or DL-KIP025** Indicator digital measuring head
3. **DL-KIP0023 or DL-KIP0028** Communication device for measuring head
4. **DL-CRN50094** Probe set and adapters
5. **DL-CRN50099** Set of 4 adapters for measuring clearances of injectors BOSCH, DENSO
6. **DL-CRistina** Injector control signal activator "Valve stroke actuator" with kit cables including:
 - Power cable 220V - 1 pc.
 - Main cable for connection to the electromagnet – 1 pc.
 - Adapter cable for light injector – 1 pc.
 - Adapter cable for cargo injector – 1 pc.
7. CRistina Software
8. **DL-PASSCRistina** Passport (technical description, instruction manual)
9. **D-MV200UM** Electron microscope
10. **D-07147122** Torque wrench 1/2" 20-100 Nm
11. **DL-CR50104** Support ring set
12. **DL-UNI30390** Wrench for removing the solenoid for CR injectors with a 30 mm hexagon.
13. **DL-UNI30389** Wrench for removing the solenoid for CR injectors with a 29 mm hexagon.
14. **DL-UNI30435** Wrench for removing the solenoid of CR injectors with a 28 mm dodecahedron.
15. **DL-UNI30434** Wrench for removing the solenoid of CR injectors with a 27 mm dodecahedron.
16. **DL-UNI50046** 3-prong wrench for removing the nut in the electronic part of DENSO injectors.
17. **DL-UNI30545** Wrench for removing the nut in the electronic part of Siemens injectors **DL-UNI30545**
18. **DL-UNI50050** A set of wrenches for dismantling the atomizer nut (hexagon 14 mm, 15 mm, 17mm, 19mm, 16mm and 17.5mm octagon and 27mm wrench)
19. **DL-CR30561** Wrench for dismantling the multiplier nut for Bosch CR injectors, hexagon 10 mm.
20. **DL-TORX10** Wrench for removing the nut in the electronic part of Bosch injectors 10 mm.

21. **DL-TORX12** Wrench for removing the nut in the electronic part of Bosch injectors 12 mm.
22. **DL-AP2** Set of 2 anti-magnetic tweezers.
23. **DL-08CR5-244** Adjusting washers 55 pcs.
24. **DL-09CR5-219** Adjusting washers 55 pcs.
25. **DL-11CR5-236** Adjusting washers 55 pcs.
26. **DL-12CR5-230** Adjusting washers 130 pcs.
27. **DL-16CR5-232** Adjusting washers 60 pcs.
28. **DL-18CR5-271** Adjusting washers 55 pcs.
29. **DL-19CR5-273** Adjusting washers 55 pcs.
30. **DL-25CR5-288** Adjusting washers 55 pcs.
31. **DL-28CR5-287** Adjusting washers 110 pcs.
32. **DL-125** Vice L=125 mm
33. **DL-STN** Special table-workbench with two drawers included:
 - Table with two drawers
 - Perforated wall for tool placement
 - Lighting ramp with two holders
 - PC shelf
 - Shelf for signal generator
34. PC with monitor, keyboard
35. **DL-KIP010** Digital measuring head 0-12.7mm, 0.01µm (1pc)
36. **DL-KIP011** Digital measuring head 0-12.7mm, 0.001µm (2pcs)
37. **DL-KIP012** Digital measuring head 0-25.4mm, 0.001µm (1pc)
38. **DL-ST-01** Clamp for disassembly-assembly of injectors.
39. **DL-CRN50113** Set of goniometers to control the tightening of
40. **D-1012020001** Stainless steel bath
41. **DL-M035** Digital micrometer
42. **DL-M040** Tripod stand for micrometer
43. **D-07147120** Torque wrench 1/4"-1/2" with a force of 1-25 Nm
44. **DL-TX10** T-key Tx10
45. **DL-TX25** T-wrench 2.5 mm.
46. **DL-TX30** T-key 3 mm

- 46. **DL-UNI31113** The socket wrench is 6-sided by 13 mm.
- 47. **DL-UNI31114** The socket wrench is 6-sided by 14 mm.
- 48. **DL-UNI31115** The socket wrench is 6-sided by 15 mm.
- 49. **DL-UNI31119** The socket wrench is 6-sided by 19 mm.
- 50. **DL-CR50052** Device for filling the hydraulic compensator of the Bosch piezo injector.
- 51. **DL-UNI50043** Universal clamping tool for CR injectors.
- 52. **DL-UNI50032** Universal clamping tool for CR DENSO injectors.
- 53. **DL-1219KIT** Set of box spanners 10mm, 12mm, 13mm, 14mm, 15mm, 17mm, 19mm
- 54. **DL-UNI30776** Adapter from 1/4" to 1/2" for torque wrench

For additional payment: *DL-UNI31117 Long hex wrench 17 mm.*

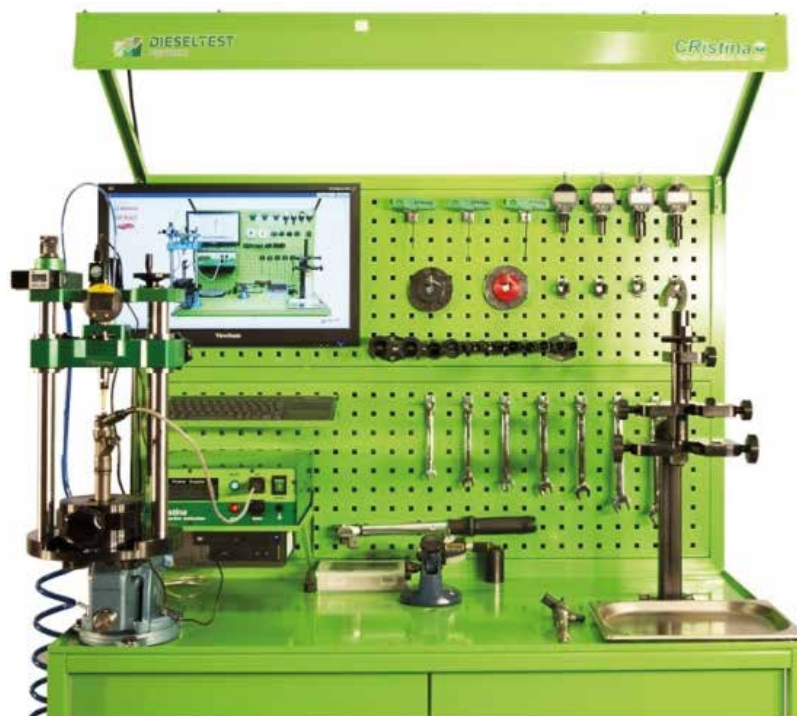

**DL-CRN50134**

Table stand for tripod CR-CRistina

Contents of delivery :

- Base **CRN30918** – 1pc
- Rack **CRN30919** – 4 pcs
- Bolt with internal hexagon DIN912 M8x25 – 8 pcs.

**DL-1019KIT**

Open-end spanner set:

Contents of delivery :

- **DL-UNI31210** - 10 mm
- **DL-UNI31212** - 12 mm
- **DL-UNI31213** - 13 mm
- **DL-UNI31214** - 14 mm
- **DL-UNI31215** - 15 mm
- **DL-UNI31217** - 17 mm
- **DL-UNI31219** - 19 mm

**DL-PNP08****Pneumatic press**

for pressing in the stop sleeve
adjusting washer of the magnetic gap of the injectors
Common Rail Bosch with pressure range 0-8 bar.

Contents of delivery :

- pneumatic press
- **DL-CRN30914** adapter
- **DL-CRN30921** pusher
- **DL-CRN30915** adapter
- **DL-CRN30920** pusher

**DL-CRN30915**

adapter

**DL-CRN30920**pusher for
pneumatic press**DL-CRN30914**

adapter

**DL-CRN30921**pusher for
pneumatic press**DL-CRNRLS02**

**Adapter kit for
pneumatic press**

Contents of delivery :

- **DL-CRN30914** adapter
- **DL-CRN30921** pusher
- **DL-CRN30915** adapter
- **DL-CRN30920** pusher

DL-CRTOOLKIT-22 Tool kit for repairing CR injectors

- | | | |
|----|--------------------|----------------------------------------------------------------------------------------------------|
| 1 | DL-CR50104 | Support ring removal/installation kit |
| 2 | DL-UNI30390 | CR injector solenoid wrench with 30 mm hexagon |
| 3 | DL-UNI30389 | Wrench for removing the solenoid for CR injectors with a 29 mm hexagon |
| 4 | DL-UNI30435 | Wrench for removing the solenoid for CR injectors with 28 mm dodecahedron |
| 5 | DL-UNI30434 | Wrench for removing the solenoid for CR injectors with 27 mm dodecahedron |
| 6 | DL-UNI50046 | 3-prong wrench for removing the nut in the electronic part of Denso injectors |
| 7 | DL-UNI30545 | Wrench for removing the nut in the electronic part of Siemens injectors |
| 8 | DL-UNI50050 | Dismantling wrench set, 14,15,17,19 mm hex, 16, 17.5 mm octagon and 27 mm wrench for torque handle |
| 9 | DL-CR30561 | Wrench for dismantling the nut of the Bosch CR injector multiplier, hexagon 10 Wrench |
| 10 | DL-UNI31010 | The key for removing the nut in the electronic part of the Bosch injector |
| 11 | DL-UNI31012 | The key for mounting / dismantling the nut of multiplier of the CRIN truck injectors |
| 12 | DL-AP2 | Set of 2 anti-magnetic tweezers DL-AP2 |
| 13 | DL-UNI31110 | T-key Tx10 |
| 14 | DL-UNI31125 | T-wrench 2.5mm |
| 15 | DL-UNI31130 | T-key 3 mm |
| 16 | DL-UNI31113 | Allen wrench hexagon 13 mm |
| 17 | DL-UNI31114 | Allen key 14 mm hex |
| 18 | DL-UNI31115 | Allen key hexagonal 15 mm |
| 19 | DL-UNI31119 | Allen key 19 mm hex |
| 20 | DL-CR50052 | Bosch piezo injector hydraulic compensator filling tool |
| 21 | DL-UNI50043 | Universal clamping tool for CR injectors |
| 22 | DL-UNI50032 | Universal clamping tool for CR Denso injectors |

DL-CRTOOLKIT-12 CR injector repair tool kit



- | | | |
|----|--------------------|----------------------------------------------------------------------------------------------------|
| 1 | DL-CR50104 | Support ring removal/installation kit |
| 2 | DL-UNI30390 | CR injector solenoid wrench with 30 mm hexagon |
| 3 | DL-UNI30389 | Wrench for removing the solenoid for CR injectors with a 29 mm hexagon |
| 4 | DL-UNI30435 | Wrench for removing the solenoid for CR injectors with 28 mm dodecahedron |
| 5 | DL-UNI30434 | Wrench for removing the solenoid for CR injectors with 27 mm dodecahedron |
| 6 | DL-UNI50046 | 3-prong wrench for removing the nut in the electronic part of Denso injectors |
| 7 | DL-UNI30545 | Wrench for removing the nut in the electronic part of Siemens injectors |
| 8 | DL-UNI50050 | Dismantling wrench set, 14,15,17,19 mm hex, 16, 17.5 mm octagon and 27 mm wrench for torque handle |
| 9 | DL-CR30561 | Wrench for dismantling the nut of the Bosch CR injector multiplier, hexagon 10 |
| 10 | DL-UNI31010 | The key for removing the nut in the electronic part of the Bosch injector |
| 11 | DL-UNI31012 | The key for mounting / dismantling the nut of multiplier of the CRIN truck injectors |
| 12 | DL-AP2 | Set of 2 anti-magnetic tweezers DL-AP2 |

CRN-50250

Set of probes and adapters

DL-CRN50099 Set of adapters for injectors:



DL-CRN30027

Needle stroke adapter
BOSCH, overstroke adapter
BOSCH CRI 2.0/2.2



DL-CRN30028



DL-CRN30029

Magnetic gap adapter BOSCH CRI 1,
CRI 2.0/2.2, CRIN 1/1.6.



DL-CRN30030



DL-CRN30031

Injector Magnetic Gap Adapter
BOSCH CR1 2.1



DL-CRN30032



DL-CRN30033

Overstroke adapter for injectors
Denso



DL-CRN30034

DL-CRN50094 Probe set:



DL -CRN30096



DL -CRN30503



DL -CRN30097



DL -CRN30099



DL -CRN50106



DL -CRN50007



DL -CRN30100



DL -CRN30098



DL -CRN30101



DL -CRN30095



DL -CRN50006

DL-CRN50113

Set of goniometers to control the tightening of the atomizer nut

Contents of delivery:**DL-CRN50107**

Protractor for injectors with nut diameter
atomizer 17 mm
Angle range: 0° - 360°

**DL-CRN50110**

Protractor for injectors with diameter
atomizer nuts 19 mm

Angle range: 0° - 360°

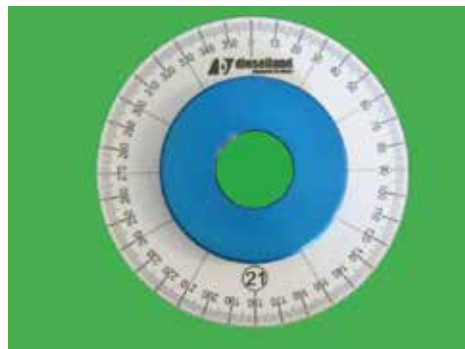
**DL-CRN50108**

Protractor for injectors with diameter
atomizer nuts 21 mm

Angle range: 0° - 360°

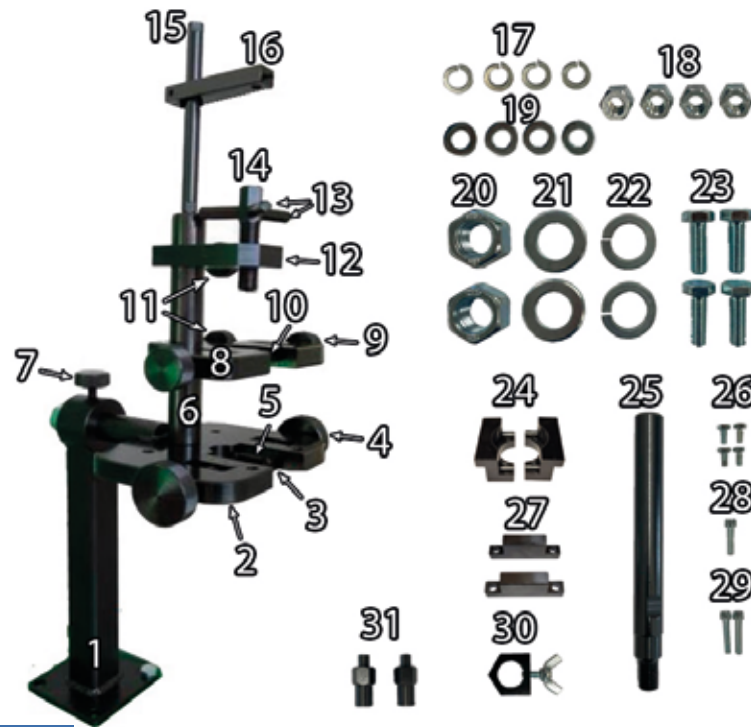

*All goniometers are for sale
also separately.*

**DL-ST01****Clamping stand for assembling and disassembling CR injectors**

Clamping stand for assembling and disassembling CR injectors allows the installation and fixation of the following types of injectors and producers: Injectors CR BOSCH CRI/CRIN; Injectors CR DENSO ; Injectors CR DELPHI ; Injectors Smart ; Injectors CR SIEMENS, Continental VDO

Contents of delivery:

1. STD50115	Rack - 1 pc.	17. Din127	Grover washer for 10 - 4 pcs.
2. STD50116	Large vice - 1 pc.	18. Din034	Nut M10m - 4 pcs.
3. STD30586	Clamp - 2 pcs.	19. Din0125	Washer 10.5x20x2 - 4 pcs.
4. STD50116	Locking handle large vise - 2 pcs.	20. Din034	Nut M20 - 2 pcs.
5. STD30498	Replaceable foot - 2 pcs.	21. Din0125	Washer 21x37x3 - 2 pcs.
6. STD30540	Guide post - 1 pc.	22. Din127	Grover 20 - 2 pcs.
7. STD30468	Retainer - 1 pc.	23. Din033	Bolt M10x30 - 4 pcs.
8. STD50117	Small vise - 1 pc.	24. STD30752	Replacement foot for Denso nozzles - 2 pcs.
9. STD30500	Locking handle small vise - 2 pcs.	25. STD30873	Axis under the sight - 1 pc.
10. STD30563	Small vise clamp - 2 pcs.	26. Din012	Screw M4x8 - 4 pcs.
11. STD30468	Locking handle - 3 pcs.	27. STD31172	Presser foot elongated - 2 pcs.
12. STD30610	Bracket - 1 pc.	28. Din012	Screw M4x16 - 1 pc.
13. STD30810	Clamp screw handles - 3 pcs.	29. Din012	Screw M4x20 - 2 pcs.
14. STD30810	Clamp screw - 1 pc.	30. STD30874	Protractor sight - 1 pc.
15. STD30812	Axle - 1 pc.	31. STD30148/ STD30147	stop Ø7 mm / stop Ø9 mm

OPTIONAL CLAMP DL-ST01

DL-STD50072 KIT

Single pump section holder kit (PLD sections)
and unit injectors Audi / VW



DL-STD50070 K

Set of single section holders
pumps (PLD sections)

Contents of delivery:

- | | | |
|---|-----------------------|----------------|
| 1 | STD-50077 | AT holder |
| 2 | STD-50078 | speaker holder |
| 3 | STD-30671 | plank |
| 4 | STD-30672 | rack |
| 5 | STD-30673 | emphasis |
| 6 | screw M10x60 - 2 pcs. | |



DL-STD50071 K

Set of holders for unit injectors
Audi/VW

Contents of delivery:

- | | | |
|---|------------------|--------------------------------|
| 1 | STD-50009 | clip VW2.0 |
| 2 | STD-50010 | clip VW1.9 |
| 3 | STD-30656 | plank |
| 4 | STD-30657 | stand - 2 pcs. |
| 5 | STD-30678 | emphasis |
| 6 | STD-30658 | bolt |
| 7 | STD31245 | Rack shortened
UIS - 2 pcs. |



DL-STD30874

Viewfinder for goniometer



DL-STD30873

Axis under sight

**DL-CR50341****Bracket with measuring adapter
BOSCH piezo injector valve travel**

Bracket with measuring adapter
BOSCH piezo injector valve travel,
applied during assembly.

Adapter included

DL-CR31201 and measuring probe **DL-CR31206**

**DL-CR50340****Bracket for measurement adapter
BOSCH piezo injector valve travel**

Bracket for measurement adapter
BOSCH piezo injector valve travel,
applied during assembly.

Adapter **DL-CR31201** and measuring probe
DL-CR31206 not included.



SPARE PARTS FOR CLAMP DL-ST01

**STD-30498**

Sponges for DL-ST01
clamping interchangeable universal

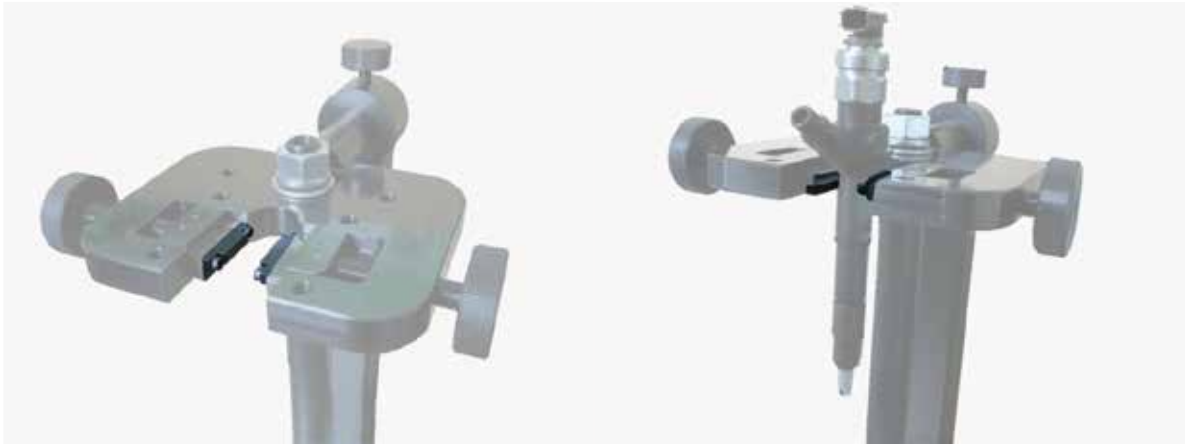
**STD-30752**

Sponges for DL-ST01
replacement clamps for Denso injectors

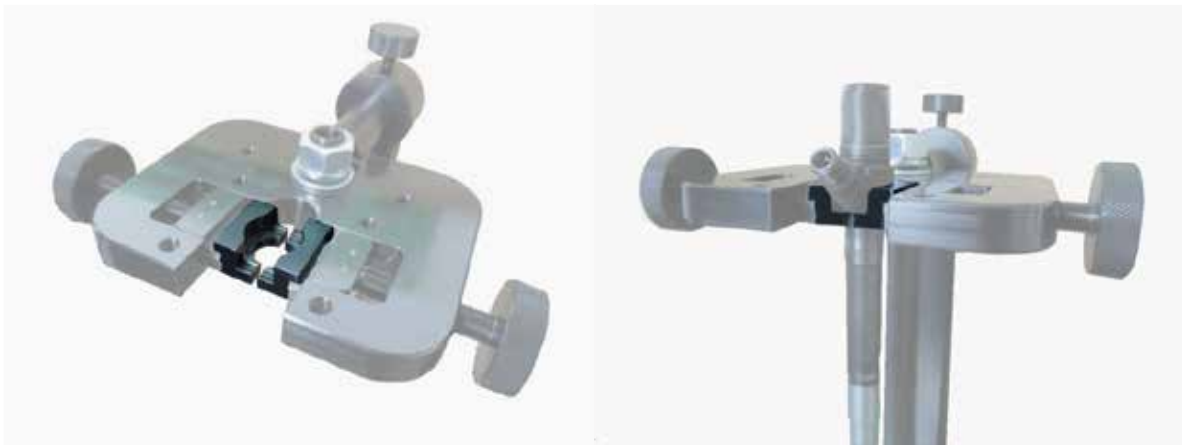

OPTIONAL CLAMP DL-ST01

**DL-STD50206**

Injector holder
AUDI / VW 1.9 to adjust
el. magnetana clamp
ST-01 / ST-02

**DL-STD50207**

Injector holder
AUDI / VW 2.0 to adjust
el. magnetana clamp
ST-01 / ST-02



DL-CRN50091**Set of adapters with digital indicators**

Adapter set with digital dial indicators for assembly gaps measurement and nozzle valve and needle stroke measurement.

**Kit includes:**

- | | |
|-----------------------------------------------------------------------------------------------------------------------------------------|----------------------|
| 1. DL-CRI 2.1-RLS-N, CRN 30031
BOSCH CR 12.1 injector magnetic gap adapter | 1.1 CRN 30032 |
| 2. DL-CRI 1-AHE, CRN 50089
Valve travel adapter for injectors BOSCH CRI 1, CRI 2.0/2.2, CRIN 1/1.6 | 2.1 CRN 30708 |
| 3. DL-DENSO016-N, CRN 30033
Denso injector overstroke adapter | 3.1 CRN 30034 |
| 4. DL-CRI-DNH-N, CRN 30027
BOSCH needle stroke adapter, BOSCH CRI 2.0/2.2 excess stroke adapter | 4.1 CRN 30028 |
| 5. DL-CRI-RLS-N, CRN 30029
Magnetic gap adapter BOSCH CRI 1, CRI 2.0/2.2, CRIN 1/1.6,
overstroke adapter BOSCH CRI 2.0/2.2 | 5.1 CRN 30030 |
| 6. DL-CRI 2.1-AHE1 CRN 30705
BOSCH CRI 2.1 injector valve stroke adapter indirect measurement | 6.1 CRN 30706 |
| 7. DL-CRI 2.1-AHE 2, CRN 30707
Адаптер хода клапана инжекторов BOSCH CRI 2.1 прямой замер | 7.1 CRN 50007 |
| 8. DL-VFK-DFK, CRN 30709
BOSCH Atomizer Spring and Armature Spring Adapter for BOSCH Injectors | 8.1 CRN 30710 |
| 9. DL-CRIN 2/3AHE, CRN 50299
Valve travel and overstroke adapter for BOSCH CRIN 2, CRIN 3 injectors | |
| 10. Digital measuring head 0-12.7mm, 0.001mm | DL-KIP011 |
| 11. Digital measuring head 0-25.4mm, 0.001mm | DL-KIP012 |
| 12. Allen key 2.5 mm | |

DL-CRN50092**Set of adapters with digital indicators**

Adapter set with digital dial indicators for assembly gaps measurement and nozzle valve and needle stroke measurement.

**Kit includes:**

- | | |
|-----------------------------------------------------------------------------------------------------------------------------------------|----------------------|
| 1. DL-CRI 2.1-RLS-N, CRN 30031
BOSCH CR 12.1 injector magnetic gap adapter | 1.1 CRN 30032 |
| 2. DL-CRI 1-AHE, CRN 50089
Valve travel adapter for injectors BOSCH CRI 1, CRI 2.0/2.2, CRIN 1/1.6 | 2.1 CRN 30708 |
| 3. DL-DENSO016-N, CRN 30033
Denso injector overstroke adapter | 3.1 CRN 30034 |
| 4. DL-CRI-DNH-N, CRN 30027
BOSCH needle stroke adapter, BOSCH CRI 2.0/2.2 excess stroke adapter | 4.1 CRN 30028 |
| 5. DL-CRI-RLS-N, CRN 30029
Magnetic gap adapter BOSCH CRI 1, CRI 2.0/2.2, CRIN 1/1.6,
overstroke adapter BOSCH CRI 2.0/2.2 | 5.1 CRN 30030 |
| 6. DL-CRI 2.1-AHE1 CRN 30705
BOSCH CRI 2.1 injector valve stroke adapter indirect measurement | 6.1 CRN 30706 |
| 7. DL-CRI 2.1-AHE 2, CRN 30707
Адаптер хода клапана инжекторов BOSCH CRI 2.1 прямой замер | 7.1 CRN 50007 |
| 8. DL-VFK-DFK, CRN 30709
BOSCH Atomizer Spring and Armature Spring Adapter for BOSCH Injectors | 8.1 CRN 30710 |
| 9. DL-CRIN 2/3AHE, CRN 50299
Valve travel and overstroke adapter for BOSCH CRIN 2, CRIN 3 injectors | |
| 10. DL-KIP025MS Digital measuring head 0-12.7mm, 0.001mm (PC connection possible) | |
| 11. DL-KIP0026 Digital measuring head 0-25.4mm, 0.001mm (PC connection possible) | |
| 12. Allen key 2.5 m | |

**DL-CRN50090**

Adapter for measuring valve stroke of CRIN 2/3 injectors. Used together with probe DL-CRN30708.

Contents of delivery:

DL-CRN50090	adapter CRIN 2/3 — 1 pc.
DL-CRN30708	probe - 1 pc.

**DL-CRN50299**

Адаптер измерения хода клапана и избыточного хода форсунок CRIN 2/3

Contents of delivery:

DL-CR31555	adapter case — 1 pc
DL-CR31527	adapter nut — 1 pc
DL-CRN30708	measuring probe — 1 pc.
DL-CR31556	anchor fixing sleeve — 1 pc

**DL-CRN50299KIT****Valve Stroke Measurement Kit and overstroke CRIN 2 / CRIN 3 with collapsible and a non-separable anchor****Contents of delivery**

- Digital indicator head **DL-KIP012** — 1 pc.
- Adapter case **DL-CR31555** — 1 pc.
- Adapter nut **DL-CR31527** — 1 pc.
- Measuring probe **CRN30708** — 1 pc.
- Fixing bushing with toujon **DL-CR31556** — 1 pc.
- L-shaped hex wrench 2.5 for fixing measuring head — 1 pc.
- L-shaped hex wrench 1.5 for fixing bushings - 1 pc

Attention! Positions are specified according to kit **DL-CRN50091**. Others may also apply indicator measuring heads are of higher quality and more expensive. CIG have the same measuring range (stroke 0-25.4 mm and resolution 0.001 mm). As an example **DL-KIP021**, **DL-KIP026**, **DL-KIP031**. All of them are available upon request.

**DL-CRN50299KIT**

Kit for measuring the valve stroke (AH) of CRIN 2 / CRIN 3 injectors with detachable and non-demountable armature

Contents of delivery:

DL-CR31586	Base - 1 pc.
DL-CR31583	Height adapter springs - 1 pc.
DL-CR31584	Height adapter washers Ahe - 1 pc.
DL-CR31585	Washer height adapter RIs - 1 pc
DL-CRN30033	Adapter for measuring the height of washers and springs - 1 pc.
DL-KIP0036	Indicator digital measuring head with an accuracy of 0.001 mm and a stroke of 25 mm - 1 pc

DL-CR50311

Set of tools and adapter for measuring the height of washers and springs CRI1/CRI2

**Contents of delivery:**

DL-CR31586	Base - 1 pc.
DL-CR31583	Height adapter springs - 1 pc.
DL-CR31584	Height adapter washers Ahe - 1 pc.
DL-CR31585	Washer Height Adapter RIs - 1 pc
DL-CRN30033	Adapter for measuring the height of washers and springs - 1 pc.

DL-CR50306

Set of devices for measuring the height of washers and springs of CRI1/CRI2 injectors

**Contents of delivery:**

DL-CR31586	Base - 1 pc.
DL-CR31583	Height adapter springs - 1 pc.
DL-CR31584	Height adapter washers Ahe - 1 pc.
DL-CR31585	Washer Height Adapter RIs - 1 pc



DL-UNI20150 CRISTINA - PIEZO

The device is designed to test piezo injectors and piezo package.

The device confidently determines all the faults of the piezo package. Identifies problems that similar instruments or stands do not detect.

The device was developed for the assembly of Siemens injectors, but it is also efficient with BOSCH injectors.

Device capabilities:

1. Signal giving to activate the nozzle on the hand press
2. Measurement of the resistance of the piezo package
3. Breakdown test on the case
4. Measuring the capacity of the piezo package
5. Measurement of the smooth running of the piezo package

Contents of delivery:

1. Signal generator "CRistina-PIEZO"
2. A set of cables to the signal generator "CRistina-PIEZO"
 - Power cable 220V
 - Main cable for connecting to the piezo package
 - Cable adapter universal
 - Adapter cable with crocodile clips
 - Earthing cable
3. Passport (technical description, operating instructions) 1 pc.

ATTENTION ! ADDITIONAL EQUIPMENT ARE POSSIBLE TOGETHER WITH THE DEVICE!



acoustic testing

DL-UNI20150A CRISTINA - PIEZO
ACOUSTIC

The device is designed to test piezo injectors and piezo package.

The device confidently determines all the faults of the piezo package. Identifies problems that similar instruments or stands do not detect.

The device was developed for the assembly of Siemens injectors, but it is also efficient with BOSCH injectors.

Device capabilities:

1. Signal giving to activate the nozzle on the hand press
2. Measurement of the resistance of the piezo package
3. Breakdown test on the case
4. Measuring the capacity of the piezo package
5. Measurement of the smooth running of the piezo package
6. Valve opening/closing control with acoustic test
7. Precise detection of valve opening and closing with an acoustic test

Contents of delivery:

1. Signal generator "CRistina-PIEZO"
2. A set of cables to the signal generator "CRistina-PIEZO"
 - Power cable 220V
 - Main cable for connecting to the piezo package
 - Cable adapter universal
 - Adapter cable with crocodile clips
 - Earthing cable
3. Microphone
4. Microphone holder
5. Passport (technical description, operating instructions) 1 pc.

ATTENTION ! ADDITIONAL EQUIPMENT ARE POSSIBLE TOGETHER WITH THE DEVICE!



DL-UNI20050 CRISTINA - PIEZO

The device is designed to test piezo injectors and piezo package.

The device confidently determines all the faults of the piezo package. Identifies problems that similar instruments or stands do not detect.

The device was developed for the assembly of Siemens injectors, but it is also efficient with BOSCH injectors.

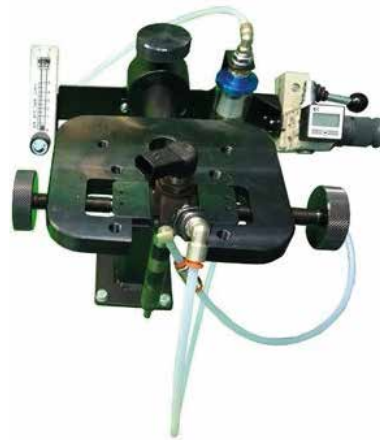
**DL-CR50157****Device capabilities:**

1. Signal giving to activate the nozzle on the hand press
2. Measurement of the resistance of the piezo package
3. Breakdown test on the case
4. Measuring the capacity of the piezo package
5. Measurement of the smooth running of the piezo package

Contents of delivery:

1. Controller CRistina-Piezo
2. The clamp-holder of injectors Piezo ST-04
3. Bracket holder.
4. The air meter.
5. The air filter.
6. The distributive air valve.
7. Reducer for air.
8. The electronic manometer.
9. Set of tubes.
10. Quick coupling 6mm.
11. Set of 2 nozzles for the backflow of the Siemens VDO injectors
12. **DL-CR50157** Set of adapters for measuring of the valve stroke of CR VDO Siemens injector (DL-CR50165 for DL-UNI20050-F)
13. Connector M12x1,5X1/8"

ATTENTION ! ADDITIONAL EQUIPMENT ARE POSSIBLE TOGETHER WITH THE DEVICE!

It differs from the DL-UNI20050F set in a less complete set of adapters for injectors.

DL-UNI20050F CRISTINA - PIEZO

The device is designed to test piezo injectors and piezo package.

The device confidently determines all the faults of the piezo package. Identifies problems that similar instruments or stands do not detect.

The device was developed for the assembly of Siemens injectors, but it is also efficient with BOSCH injectors.

**DL-CR50165****Device capabilities:**

1. Signal giving to activate the nozzle on the hand press
2. Measurement of the resistance of the piezo package
3. Breakdown test on the case
4. Measuring the capacity of the piezo package
5. Measurement of the smooth running of the piezo package

Contents of delivery:

1. Controller CRistina-Piezo
2. Clamp-holder for injectors Piezo ST-04
3. Bracket holder for equipment.
4. Air meter.
5. Air filter.
6. Air distribution crane.
7. Reducer for air.
8. Electronic manometer.
9. Set of tubes.
10. Coupling of quick connection 6mm.
11. Set of 2 fittings for backflow of Siemens VDO injectors
12. **DL-CR50165** Set of adapters for measuring the stroke of the injector valve CR VDO Siemens
13. Adapter M12x1.5X 1/8 "

ATTENTION ! ADDITIONAL EQUIPMENT ARE POSSIBLE TOGETHER WITH THE DEVICE!

It differs from the DL-UNI20050 kit in a more complete set of adapters for injectors.

 acoustic testing

**DL-UNI20050A CRISTINA - PIEZO
ACOUSTIC**

The device is designed to test piezo injectors and piezo package.

The device confidently determines all the faults of the piezo package. Identifies problems that similar instruments or stands do not detect.

The device was developed for the assembly of Siemens injectors, but it is also efficient with BOSCH injectors.

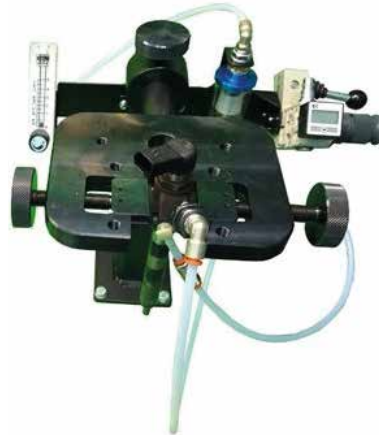
DL-CR50157
Device capabilities:

1. Signal giving to activate the nozzle on the hand press
2. Measurement of the resistance of the piezo package
3. Breakdown test on the case
4. Measuring the capacity of the piezo package
5. Measurement of the smooth running of the piezo package
6. Valve opening / closing control with acoustic test

Contents of delivery:

1. Controller CRistina-Piezo
2. Clamp-holder for injectors Piezo ST-04
3. Bracket holder for equipment.
4. Air meter.
5. Air filter.
6. Air distribution crane.
7. Reducer for air.
8. Electronic manometer.
9. Set of tubes.
10. Coupling of quick connection 6mm.
11. Set of 2 fittings for backflow of Siemens VDO injectors
12. **DL-CR50157** Set of adapters for measuring the stroke of the valve injector CR VDO Siemens
13. Adapter M12x1.5X 1/8 "
14. Microphone
15. Microphone holder
16. Passport

ATTENTION ! ADDITIONAL EQUIPMENT ARE POSSIBLE TOGETHER WITH THE DEVICE!

*It differs from the **DL-UNI20050F (A)** kit in a less complete set of adapters for injectors.*

 acoustic testing

**DL-UNI20050FA CRISTINA - PIEZO
ACOUSTIC**

The device is designed to test piezo injectors and piezo package.

The device confidently determines all the faults of the piezo package. Identifies problems that similar instruments or stands do not detect.

The device was developed for the assembly of Siemens injectors, but it is also efficient with BOSCH injectors.

DL-CR50165
Device capabilities:

1. Signal giving to activate the nozzle on the hand press
2. Measurement of the resistance of the piezo package
3. Breakdown test on the case
4. Measuring the capacity of the piezo package
5. Measurement of the smooth running of the piezo package
6. Valve opening / closing control with acoustic test

Contents of delivery:

1. Controller CRistina-Piezo
2. Clamp-holder for injectors Piezo ST-04
3. Bracket holder for equipment.
4. Air meter.
5. Air filter.
6. Air distribution crane.
7. Reducer for air.
8. Electronic manometer.
9. Set of tubes.
10. Coupling of quick connection 6mm.
11. Set of 2 fittings for backflow of Siemens VDO injectors
12. **DL-CR50165** Set of adapters for measuring the stroke of the injector valve CR VDO Siemens
13. Adapter M12x1.5X 1/8 "
14. Microphone
15. Microphone holder
16. Passport

ATTENTION ! ADDITIONAL EQUIPMENT ARE POSSIBLE TOGETHER WITH THE DEVICE!

Differs from **DL-UNI20050 (A)** kit in more complete set of injector adapters

DL-UNI20051 Комплект с CRistina-PIEZO

Repair kit for piezo injectors CR Siemens / VDO (without clamp for clamping injectors and acoustic test). The device confidently detects all malfunctions of the piezoelectric package. Identifies problems that similar instruments or benches do not detect.

The device was developed for assembling Siemens injectors, but it is also functional with Bosch injectors.

**Device capabilities:**

1. Signal giving to activate the nozzle on the hand press
2. Measurement of the resistance of the piezo package
3. Breakdown test on the case
4. Measuring the capacity of the piezo package
5. Measurement of the smooth running of the piezo package

Contents of delivery:

1. Controller CRistina-Piezo
 2. Bracket holder for equipment.
 3. Air meter.
 4. Air filter.
 5. Air distribution crane.
 6. Reducer for air.
 7. Electronic manometer.
 8. Set of tubes.
 9. Quick coupling 6mm.
 10. Set of 2 fittings for backflow of Siemens VDO injectors
 11. Adapter M12x1.5X 1/8 "
- DL-UNI20051A CRistina-PIEZO kit with acoustic test
Repair kit for piezo injectors CR Siemens / VDO (without clamp for clamping injectors)

ATTENTION ! ADDITIONAL EQUIPMENT ARE POSSIBLE TOGETHER WITH THE DEVICE!

 acoustic testing

DL-UNI20051A Комплект с CRistina-PIEZO

Repair kit for piezo injectors CR Siemens / VDO (without clamp for clamping injectors with acoustic test). The device is designed to test the piezo injector of the piezo package. The device confidently detects all malfunctions of the piezoelectric package. Identifies problems that similar instruments or benches do not detect.

The device was developed for assembling Siemens injectors, but it is also functional with Bosch injectors.

**Device capabilities:**

1. Signal giving to activate the nozzle on the hand press
2. Measurement of the resistance of the piezo package
3. Breakdown test on the case
4. Measuring the capacity of the piezo package
5. Measurement of the smooth running of the piezo package
6. Valve opening / closing control with acoustic test

Contents of delivery:

1. Controller CRistina-Piezo
2. Bracket holder for equipment.
3. Air meter.
4. Air filter.
5. Air distribution crane.
6. Reducer for air.
7. Electronic manometer.
8. Set of tubes.
9. Quick coupling 6mm.
10. Set of 2 fittings for backflow of Siemens VDO injectors
11. Adapter M12x1.5X 1/8 "
12. Microphone
13. Microphone holder
14. Passport

ATTENTION ! ADDITIONAL EQUIPMENT ARE POSSIBLE TOGETHER WITH THE DEVICE!

ADDITIONAL EQUIPMENT FOR CRISTINA-PIEZO

**DL-UNI20054** ACOUSTIC BOARD**Acoustic test kit for CRISTINA - PIEZO****The kit includes:**

1. Microphone in a plastic case
2. Clip for fixing the microphone on the nozzle body
3. Acoustic test board for installation inside the instrument CRISTINA -PIEZO
4. Set of connecting wires
5. Set of racks and bolts for fixing the board
6. Instructions for assembly.

**DL-UNI20052**

**Injector repair kit
CR Siemens VDO (without controller
Cristina-Piezo.**

Contents of delivery:

1. Clamp-holder of nozzles PiezoST-04
2. Equipment holder bracket.
3. Air meter.
4. Air filter.
5. Air distribution valve.
6. Reducer for air.
7. Electronic pressure gauge.
8. Set of tubes.
9. 6mm quick coupling.
10. Set of 2 fittings for reverse
Siemens injector drain
11. Adapter M12x1.5 X 1/8"

**DL-UNI20053**

**Injector repair kit
CR Siemens VDO (without controller
CRistina-Piezo and clamps ST-04)**

Contents of delivery:

- | | |
|------------------------------------------------------------------------------------------------------------------------------------------------------------------------------------------------|------------------------------------------------------------------------------------------------------------------------------------------------------------------------------------------------------------------------------------------------------|
| <ol style="list-style-type: none"> 1. Equipment holder bracket. 2. Air meter. 3. Air filter. 4. Air distribution valve. 5. Reducer for air. | <ol style="list-style-type: none"> 6. Electronic pressure gauge. 7. Set of tubes. 8. 6mm quick coupling. 9. Set of 2 fittings for
backflow of SiemensVDO injectors 10. Adapter M12x1.5 X 1/8" |
|------------------------------------------------------------------------------------------------------------------------------------------------------------------------------------------------|------------------------------------------------------------------------------------------------------------------------------------------------------------------------------------------------------------------------------------------------------|

ADDITIONALLY! For kits **DL-UNI20051, DL-UNI20052, DL-UNI20053** requires a set of adapters with measuring head **DL-CR50157** for 6 pos. or **DL-CR50165** for 8 positions



DL-CR50146

Adapter set without indicator head for measurement injector parameters CR VDO Siemens.

Contents of delivery:

1. **DL-CR31079** Adapter for testing the piezo package.
2. **DL-CR50147** Adapter (body with nut) for measuring valve travel.
3. **DL-CR31177** Measuring probe
4. **D-7153136** Hex key 2mm



DL-CR50157

Adapter kit with indicator head for measuring parameters injectors CR VDO Siemens.

Contents of delivery:

1. **DL-CR31079** Adapter for testing the piezo package.
2. **DL-CR50147** Adapter (body with nut) for measuring valve travel.
3. **DL-CR31177** Measuring probe
4. **D-7153136** Hex key 2mm
5. **DL-KIP002** Indicator measuring mechanical head with precision 0.001mm, travel 5mm
6. Organizer



DL-CR50165

**Adapter set with indicator head for measuring valve travel
CR VDO Siemens injectors of all types.**

Contents of delivery:

1. **DL-CR31079** Adapter for measuring the parameters of the piezo injector package new type M25x1
2. **DL-CR31179** Adapter for measuring the parameters of the piezo injector package old type M27x1
3. **DL-CR31080** Adapter housing for measuring the stroke of the injector valve
4. **DL-CR31081** Nut to body of adapter for measuring valve travel nozzles of a new type M25x1
5. **DL-CR31178** Nut to the body of the adapter for measuring the valve travel nozzles of a new type M27x1
6. **D-7153136** Hex key 2mm
7. **DL-KIP002** Indicator measuring head mechanical 0.001mm travel 5mm
8. **DL-CR31177** Measuring probe
9. Organizer

DL-CR50166

**Adapter kit without indicator head for measuring valve travel
CR VDO Siemens injectors of all types.**

The kit is identical to **DL-CR50165**, except for the indicator mechanical measuring head.

**DL-CR50168****Set of adapters and wrenches for repairing CR VDO Siemens injectors****Contents of delivery:**

1. **DL-CR50165** **Set of adapters with indicator head for measuring valve travel of the CR VDO Siemens injector of all types.**
 1. **DL-CR31079** Adapter for measuring the parameters of the piezo injector package new type M25x1
 2. **DL-CR31179** Adapter for measuring the parameters of the piezo injector package old type M27x1
 3. **DL-CR31080** Adapter housing for measuring the stroke of the injector valve
 4. **DL-CR31081** Nut to body of adapter for measuring valve travel nozzles of a new type M25x1
 5. **DL-CR31178** Nut to the body of the adapter for measuring the valve travel nozzles of a new type M27x1
 6. **D-7153136** Hex key 2mm
 7. **DL-KIP002** Indicator measuring head mechanical 0.001mm travel 5mm
 8. **DL-CR31177** Measuring probe
 9. Organizer

2. **DL-CR50163** **Wrench for mounting / dismantling the piezo package of CR injectors VDO Siemens.**



With the help of an elongated base, this wrench provides convenient work with CR VDO Siemens injectors. The closed zones of the nozzle are excluded and the adjustment of the piezo package is facilitated. Landing dimensions of the key:

- a) hexagon for piezo package 25mm
- b) 1/2" square for torque wrench

3. **DL-CR50164** Wrench for mounting / dismantling the piezo package of CR injectors VDO Siemens.



With the help of an elongated base, this wrench provides convenient work with CR VDO Siemens injectors. The closed zones of the nozzle are excluded and the adjustment of the piezo package is facilitated. Landing dimensions of the key:

- a) hexagon for piezo package 27mm
- b) 1/2" square for torque wrench

4. **DL-UNI30545** Wrench for mounting / dismantling the multiplier nut SIEMENS injectors



ATTENTION! All keys are sold separately.



DL-CR30843

Key attachment for convenient and safe tube removal piezo injectors (turnkey 27 mm).

Prevents nozzle breakage
injector backflow.



DL-RP430

**Manufacturer - ZECA (Italy)
Flame test chamber (aspirator)
nozzle spray.**

Allows visual sprayer quality control
diesel injectors without harm to health.
The device collects the working fluid
for reuse.

**DL-RP400****Manual press for injector testing with mechanical pressure gauge****Contents of delivery:**

- mechanical press - 1 pc.
- mechanical pressure gauge - 1 pc.
- connecting tube – 2 pcs.

**DL-RP410** (without pressure sensor)**DL-RP415** (with pressure sensor. 1500 bar)**Manual press for injector testing with electronic pressure gauge****Contents of delivery:**

- mechanical press - 1 pc.
- connecting tube – 2 pcs.
- electronic pressure gauge with cable – 1 pc.
- battery charger - 1 pc.
- pressure sensor (for **RP 415**) for 1500 bar – 1 pc.

**DL-RP420** (without pressure sensor)**DL-RP425** (with pressure sensor. 1500 bar)**Manual press for injector testing with 2-channel electronic pressure gauge****Contents of delivery:**

- mechanical press - 1 pc.
- connecting tube – 2 pcs.
- electronic pressure gauge with cable – 1 pc.
- battery charger - 1 pc.
- pressure sensor (for **RP 425**) for 1500 bar – 1 pc.

**DL-RP430****Manufacturer - ZECA (Italy)**
Flame test chamber (aspirator)
nozzle spray

Allows for visual inspection performance of diesel injectors without harm to health.

The device is going to work liquid for reuse.

**DL-RP500**

Manufacturer - ZECA (Italy)
Manual press for injector testing with mechanical pressure gauge

Contents of delivery:

- mechanical press - 1 pc.
- mechanical pressure gauge - 1 pc.
- connecting tube – 2 pcs.

**DL-RP510** (without pressure sensor)**DL-RP515** (with pressure sensor. 1500 bar)

ZECA hand press for injector testing with electronic pressure gauge

Contents of delivery:

- mechanical press - 1 pc.
- connecting tube – 2 pcs.
- electronic pressure gauge with cable – 1 pc.
- battery charger - 1 pc.
- pressure sensor (for **RP 515**) for 1500 bar – 1 pc.

**DL-RP520** (without pressure sensor)**DL-RP525** (with pressure sensor. 1500 bar)

ZECA hand press for injector testing with 2-channel electronic pressure gauge

Contents of delivery:

- mechanical press - 1 pc.
- connecting tube – 2 pcs.
- electronic pressure gauge with cable – 1 pc.
- battery charger - 1 pc.
- pressure sensor (for **RP 525**) for 1500 bar – 1 pc.

**DL-UNI20150****Cristina-PIEZO instrument**

The device is designed to test piezo injectors and piezo package

Instrument capabilities:

- Sending a signal to activate the nozzle on the hand press
- Piezo resistance measurement
- Case breakdown test
- Measuring the capacitance of a piezo pack
- Measuring the smooth running of a piezo

o

ATTENTION! Hand press not included!



MP-250 SASH

**Machine for fast and precise
valve seat restoration
injector multiplier
BOSCH Common Rail.**

Restoration is achieved by the translational-rotational action of the lap in a special abrasive medium on the seat of the damaged nozzle valve.

Available in 2 versions:

- **MP-250 SASH-Z** with collet chuck
- **MP-250SASH-S** with self-locking chuck.

- **Vibration mechanism in a protective case.**
- **Screw adjustment on table height.**
- **Compactness.**

Contents of delivery:

- **MPS30515** Lapping at 120 ° - 5 pcs.
- **MPS30516** Lapping at 124 ° - 5 pcs.
- grinding paste diamond ASM 7/5(k)
- grinding paste diamond ASM 5/3 (k)
- grinding paste diamond ASM 3/2 (k)
- **DL-MPZ30336** valve holder
electromagnetic injectors



A set of lapping diamond pastes for the MP-250 machine **DL-ACM3(K) KIT**



- **DL-ACM75K** Lapping paste diamond fraction 7/5 microns, 25 gr.
- **DL-ACM53K** Lapping paste diamond fraction 5/3 microns, 25 gr.
- **DL-ACM32K** Lapping paste diamond fraction 3/2 microns, 25 gr.

**DL-MPS31241****Spray body holder piezo injectors BOSCH**

Used for hull restoration atomizer of piezo injectors BOSCH. Suitable for lapping machine MP-250 SASH.

Application:

Suitable for BOSCH injectors piezo series 0445115

**DL-MPS31240 Medium soft lap (CM)**

for restoring the atomizer housing of CR BOSCH piezo injectors. Sharpening angle 60 degrees.
Example: BOSCH CR 04455115

**DL-MPS31250 Medium hard lap**

to restore the spray body of the piezo nozzles from BOSCH. The sharpening angle is 60 degrees.
Example: BOSCH CR 04455115

**DL-MPS31322 Elbor lap of increased hardness (PT)**

for restoring the atomizer housing of CR BOSCH piezo injectors. Sharpening angle 60 degrees.
Example: BOSCH CR 04455115

**DL-MPS31291****Lapping for the restoration of the valve regulators pressure pumps CR CP-1**

Restoration is carried out using a machine lapping of injector valves MP-250 SASH

**DL-MPS31705****Lapping 64 degrees for grinding the sprayer body Caterpillar injectors****DL-MPS31704****Caterpillar Nozzle Sprayer Housing Holder**

Restoration is carried out during processing on the MR-250 lapping machine

**DL-CR31199****BOSCH CR piezoelectric valve seat retainer during its restoration**

- Suitable for piezo injectors BOSCH 0445115
- Adapted for lapping machine SASH MP-250
- It can also be used for machines of other manufacturers.

**DL-MPS50173****Restoration Lapping Kit
BOSCH Piezo injector valve**

The kit includes laps with different angles:

1. DL-MPS31220 (angle 77 gr.) - 7 pcs.
2. DL-MPS31221 (angle 127 gr.) - 7 pcs.

ATTENTION!

All laps are also sold separately!

ACCESSORIES FOR MACHINE MP-250



DL-MPS50033	Self-tightening chuck for MP-250S assy	1 pc
DL-MPS30341	Axle (Shaft Ø12) for MP-250S	1 pc
DL-MPS30298	Chuck body for MP-250S	1 pc
DL-MPS30299	Cartridge cover for MP-250S	1 pc
DL-MPS30297	Capture for MP-250S	2 pcs
DL-MPS30364	Cartridge cover (protective) for MP-250S	1 pc
DL-MPS30338	Washer for plastic cover for MP-250S	1 pc
DL-MPS30337	Upper washer for MP-250S	1 pc

**DL-MPS30364**

Cartridge protective cover

**DL-MPS30297**

Capture for MP-250S

**DL-MPZ30506**plastic pad for MP-250S
and MP-250Z**DL-MPS30337**

Top washer for MP-250S

**DL-MPS30338**Washer for plastic
trim for MP-250S



DL-ACM3(K) KIT

**Lapping diamond set
pastes for the MP-250 machine**

DL-ACM75K

Lapping paste diamond. Fraction of grain large 7/5 microns, 25 gr.

DL-ACM53K

Lapping paste diamond. Fraction of grain average 5/3 microns, 25 gr.

DL-ACM32K

Lapping paste diamond. Grain fraction small 3/2 microns, 25 gr.



DL-CR50112

**Set of laps for CR injector valve
seat recovery**

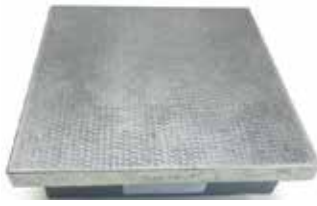

D-261102

Lapping plate
Size: 200X200 mm

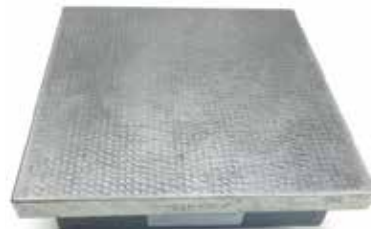

D-190171108

Lapping plate
Size: 300X300 mm



D-190171207

Lapping plate
Size: 400X400 mm



DL-UNI50270

Set of holders for grinding washers

Set of holders for grinding washers

The set includes two holders with diameters for different washers.

We recommend sanding on a special lapping plate



DL-UNI31635

**Holder for lapping spacers and
nozzle valves Piezo Bosch**

TOM-2**CP-230 Grinding machine for dressing of the laps**

- The greatest transverse movement – 100mm.
- The greatest longitudinal movement – 70mm.
- Width of a working surface of a table – 200mm.
- Length of a working surface of a table – 90mm.
- Power supply: ~220 B±15%;
- Engine power – 0,23 kWt.
- Dimensions (length x width x height), mm 400x280x260
- Weight, kg – 21
- Revolutions per minute on the engine: – 2760
- Revolutions per minute on the drive shaft: – 200

TOM-2**Additional equipment and accessories****DL-UNI20212****Stone abrasive with grain 36**

- outer diameter 125 mm
- internal diameter 12.7 mm
- thickness 16 mm
- processing speed 35 m/s

**DL-UNI20213****Stone abrasive with grain 60**

- outer diameter 125 mm
- internal diameter 12.7 mm
- thickness 16 mm
- processing speed 40 m/s

**DL-UNI20214****Stone abrasive with grain 80**

- outer diameter 125 mm
- internal diameter 32 mm
- thickness 10 mm
- processing speed 40 m/s

**DL-UNI20215****Stone abrasive with grain 120**

- outer diameter 125 mm
- internal diameter 12.7 mm
- thickness 16 mm
- processing speed 40 m/s

**DL-UNI20218****Stone abrasive with grain 230**

- outer diameter 125 mm
- internal diameter 12.7 mm
- thickness 16 mm
- processing speed 40 m/s

**DL-UNI20220****Stone abrasive with grain 400**

- outer diameter 125 mm
- internal diameter 12.7 mm
- thickness 16 mm
- processing speed 40 m/s

TOM-5**Grinding machine for dressing of the laps and other bodies of revolution**

The largest transverse movement	+/-50mm
The largest longitudinal movement	+/-50mm
Angle of rotation of the working carriage	270°
Type of electronic protractor	Absolute
Granularity of abrasive stone (cup)	100 grit
Supply voltage	~ 220 V ± 15%
Power of the electric motor of the main drive	0.2 kW
Maximum power consumption of the machine	0.3 kW
The number of revolutions per minute of the electric motor	0–12000
The number of revolutions per minute of the drive shaft	0–2000
Dimensions (Depth x Width x Height), mm	335x250x300
Dimensions with lamp (Depth x Width x Height), mm	335x250x450
Machine weight (net), kg	22

TOM-5**Additional equipment and accessories****DL-UNI20224****Cup abrasive with grain 80**

- outer diameter 50 mm
- internal diameter 13 mm
- height 32 mm
- processing speed 35 m/s

**DL-UNI20225****Stone abrasive with grain 100**

- Outer diameter 125 mm
- Inner diameter 12.7 mm
- Thickness 16 mm
- Processing speed 35 m/s

**DL-UNI20226****Stone abrasive with grain 200**

- outer diameter 125 mm
- internal diameter 12.7 mm
- thickness 16 mm
- processing speed 35 m/s

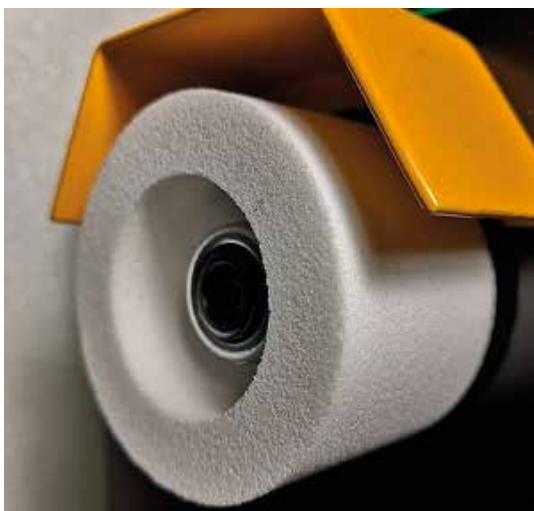

DI-CR50174

BOSCH PIEZO injector recovery kit



Contents of delivery:

1. **DL-CR50160** Clamp for pressing pins injector valve core.
2. **DL-CR31199** Valve seat holder for BOSCH CR piezo injectors during its restoration.
3. **DL-CR50169** Adapter for measuring the stroke of the BOSCH piezo injector valve
4. **DL-MPS31220** Lapping 77 degrees (6 pcs.)
5. **DL-MPS31221** Lapping 127 degrees (6 pcs.)
6. **DL-CR50209-15** Collet chuck valve holder for BOSCH piezo injectors.
7. **DL-CR31204** Plate N1 for injector valve recovery CR BOSCH Piezo
8. **DL-CR31205** N2 plate for injector valve recovery CR BOSCH Piezo
9. **DL-KIP002** Indicator measuring head of the clock type.

**DL-CR50160**

Press-in clamp CR injector valve core pins piezo BOSCH.

Suitable for BOSCH piezo series injectors **0445115**

**DL-CR50169**

Adapter for measuring the stroke of the injector valve piezo BOSCH.

Suitable for BOSCH piezo series injectors **0445115**

Contents of delivery:

1. Adapter DL-CR31201
2. Measuring probe DL-CR31206

ATTENTION!

The measuring head is not included in the scope of delivery!

**DL-CR50340**

Bracket for measurement adapter BOSCH piezo injector valve travel

Bracket for measurement adapter BOSCH piezo injector valve travel, applied during assembly.

Adapter **DL-CR31201** and measuring probe **DL-CR31206** not included.

**DL-CR31204**

Lapping plate N1 for valve recovery injectors CR BOSCH Piezo

**DL-CR31205**

Lapping plate N2 for valve recovery injectors CR BOSCH Piezo

**DL-HK50259**

Universal device for filling the hydraulic compensator of Piezo injectors BOSCH and pressing/unpressing pins of nozzles SIEMENS / BOSCH Piezo

The first purpose is filling the hydraulic compensator of the Piezo BOSCH injectors. The second purpose is to dismantle and press the pins of the valve core of the Common Rail Piezo BOSCH 0445115 injectors. The third purpose is dismantling and pressing the pins of the valve core of Common Rail SIEMENS injectors.

In the first and in the second case, an elongated cartridge with a hole is used. In the third case, a short cartridge without a hole is used.

Scope of delivery:

Universal fixture - 1 pc,
Elongated cartridge - 1 pc,
Short cartridge — 1 pc.

**DL-CR50209**

collet chuck valve holder piezo injectors BOSCH for restoration geometry by lapping.

Collet chucks are divided by accuracy:

DL-CR50209-5 Collet chuck runout up to 1-5 microns

DL-CR50209-10 Collet chuck runout up to 6-10 microns

DL-CR50209-15 Collet chuck runout up to 11-15 microns

**DL-CR50052**

Filler hydraulic compensator for Bosch piezo injectors.

Consists of two parts: housings with guides and clamps.

DL-GR7500**Grinding machine for the needles of nozzles**

Grinding machine for dressing needles of nozzles with rotation speed indicators

The machine is controlled by PWM controllers.

The control of the speed of rotation of the spindle and the processed body is regulated by means of rotary knobs located on the control panel.

Adjusting the brightness of the lower illumination of the processed body of rotation is performed using the rotary knob located in the upper part of the control panel.

The control panel has a general power switch for the machine and three power switches on each electric motor of the corresponding drive and lower lighting bulbs.

On the rear side of the machine body there is a connector for supplying a 220-volt power cable, two 220-volt sockets and a 12-volt connector for connecting a monitor.

On the front side of the machine body there is a 12 volt connector for connecting the electric motor power cable to drive rotation bodies.

The grinding machine **DL-GR7500** can be used in conjunction with the kits: **DL-UNI20025**, **DL-UNI20026**, **DL-UNI20027**, **DL-UNI20030**.

which includes: electronic industrial microscope, tripod holder, top illumination and monitor. This kit is not included in the scope of supply and is available by separate order.

DL-GR7400**Grinding machine for nozzle needles with rotation speed indicators in percent**

The **DL-GR7400** machine is used for grinding needles of nozzles and other bodies of rotation. The machine is controlled by PWM controllers.

The control of the speed of rotation of the spindle and the processed body is regulated by means of rotary knobs located on the control panel.

Rotation speed (revolutions) is displayed as a percentage. Adjusting the brightness of the lower illumination of the processed body of rotation is performed using the rotary knob located in the upper part of the control panel.

The control panel has a general power switch for the machine and three power switches for each electric motor of the corresponding drive and a backlight.

On the rear side of the machine body there is a connector for supplying a 220-volt power cable, two 220-volt sockets and a 12-volt connector for connecting a monitor.

On the front side of the machine body there is a 12 volt connector for connecting the electric motor power cable to drive rotation bodies.

The grinding machine DL-GR7400 can be used in conjunction with the kits: **DL-UNI20025**, **DL-UNI20026**, **DL-UNI20027**, **DL-UNI20030**.

which includes: electronic industrial microscope, tripod holder, top illumination and monitor. This kit is not included in the scope of supply and is available by separate order.

DL-GR7300**Grinding machine for the needles of nozzles
with speed indicators**

The **DL-GR7300** machine is used for sharpening needles of atomizers and other bodies of rotation. The machine is controlled by PWM controllers.

The control of the speed of rotation of the spindle and the processed body is regulated by means of rotary knobs located on the control panel.

Adjusting the brightness of the lower illumination of the processed body of rotation is performed using the rotary knob located in the upper part of the control panel.

The control panel has a general power switch for the machine and three power switches on each electric motor of the corresponding drive and lower lighting bulbs.

On the rear side of the machine body there is a connector for supplying a 220-volt power cable, two 220-volt sockets and a 12-volt connector for connecting a monitor.

On the front side of the machine body there is a 12 volt connector for connecting the electric motor power cable to drive rotation bodies.

The grinding machine DL-GR7300 can be used in conjunction with the kits: **DL-UNI20025**, **DL-UNI20026**, **DL-UNI20027**, **DL-UNI20030**.

which includes: electronic industrial microscope, tripod holder, top illumination and monitor. This kit is not included in the scope of supply and is available by separate order.

OPTIONAL EQUIPMENT AND ACCESSORIES TO
GRINDING MACHINES GR-7300 , GR-7400 AND GR-7500**DL-UNI20025**

Set with industrial microscope, elongated tripod, light and monitor.

The microscope has a clear image and high resolution.

**Technical data:**

1. The magnification of the microscope: 8x-130x
2. Working distance : 50-200mm
3. Connect to monitor via ports: HDMI/VGA
4. Microscope size (width x length): 40mm x 115mm

Contents of delivery:

1. **DL-UNI20016** Industrial electronic microscope with power supply (HDMI / VGA / AV).
2. **DL-UNI20019** Tripod holder extended for microscope
3. **DL-UNI20018** Lamp diode for a microscope.
4. **DL-UNI20021** Monitor
5. **DL-UNI20022** Dedicated monitor holder on a tripod

ATTENTION! All equipment from the delivery set is sold separately!



OPTIONAL EQUIPMENT AND ACCESSORIES TO
GRINDING MACHINES GR-7300 , GR-7400 AND GR-7500**DL-UNI20030**

Set with industrial microscope, elongated tripod, light and monitor.

The microscope has a clear image and high resolution.

**Technical data:**

1. The magnification of the microscope: 8x-130x
2. Working distance : 50-200mm
3. Connect to monitor via ports: HDMI/VGA
4. Microscope size (width x length): 40mm x115mm

Contents of delivery:

1. **DL-UNI20010** Industrial electronic microscope with power supply (HDMI / USB / AV).
2. **DL-UNI20019** Tripod holder extended for microscope
3. **DL-UNI20018** Lamp diode for a microscope.
4. **DL-UNI20021** Monitor
5. **DL-UNI20022** Dedicated monitor holder on a tripod

ATTENTION! All equipment from the delivery set is sold separately!



OPTIONAL EQUIPMENT AND ACCESSORIES TO
GRINDING MACHINES GR-7300 , GR-7400 AND GR-7500**DL-UNI20026**

Set with industrial microscope, elongated tripod, light and monitor.

The microscope has a clear image and high resolution.

**Technical data:**

1. The magnification of the microscope: 5x-100x
2. Working distance : 50-170mm
3. Connect to monitor via ports: HDMI
4. Microscope size (width x length): 40mm x 115mm

Contents of delivery:

1. **DL-UNI20013** Industrial electronic microscope with power supply and backlight (HDMI / USB).
2. **DL-UNI20019** Tripod holder extended for microscope
3. **DL-UNI20021** Monitor
4. **DL-UNI20022** Dedicated monitor holder on a tripod

ATTENTION! All equipment from the delivery set is sold separately!



OPTIONAL EQUIPMENT AND ACCESSORIES TO
GRINDING MACHINES GR-7300 , GR-7400 AND GR-7500**DL-UNI20027**

Set with industrial microscope, elongated tripod, light and monitor.

The microscope has a clear image and high resolution.

**Technical data:**

1. The magnification of the microscope: 10x-180x
2. Working distance : 100-150mm
3. Connect to monitor via ports: HDMI
4. Microscope size (width x length): 40mm x115mm

Contents of delivery:

1. **DL-UNI20014** Industrial electronic microscope with power supply (HDMI / USB / AV).
2. **DL-UNI20019** Tripod holder extended for microscope
3. **DL-UNI20018** Lamp diode for a microscope
4. **DL-UNI20021** Monitor
5. **DL-UNI20022** Dedicated monitor holder on a tripod

ATTENTION! All equipment from the delivery set is sold separately!



DL-UNI20031**Microscope kit HDMI USB 1080P
FHD 48MP x 200**

The microscope has a clear image and high resolution
Lens: 200X C-MOUNT magnification

**Technical data:**

1. Photo / video shooting
2. Additional functions: adding guide lines, image fixation, mirroring, image rotation, digital zoom
3. Housing: aluminum alloy
4. Matrix: Panasonic
5. Matrix resolution 48 MP
6. Frame rate: at 1920*1080 / 60fps
7. Outputs: USB, HDMI, TF card, infrared sensor for remote control
8. Power supply: DC-12V/1A
9. Max TF card capacity: 64G
10. HDMI image resolution: 8168*6128 4:3 (50MP) 8168*4592 16:9 (37MP) (for TF card),
11. USB image resolution: 1920*1080 (for PC USB)
12. Video resolution: 1920*1080/60fps for HDMI, 1920*1080/30fps 1280*720 / 30fps 640*480 / 30fps 320*240 / 30 fps for USB
13. Video format: MP4
14. Picture format: JPG
15. Remote control
16. Language support: Russian, Chinese, English, French, Spanish, Portuguese, German, Italian, Japanese
17. Lens: 200X C-MOUNT magnification
18. Working distance: 95mm (maximum working distance 16cm)
19. Zoom Ratio: 6.5:1

Contents of delivery:

1. **DL-UNI20023** Microscope electronic promiscuous with power supply (HDMI / USB / AV)
2. **DL-UNI20019** Tripod holder extended for microscope
3. **DL-UNI20018** Lamp diode for a microscope
4. **DL-UNI20021** Monitor
5. **DL-UNI20022** Dedicated monitor holder on a tripod

ATTENTION! All equipment from the delivery set is sold separately!

OPTIONAL EQUIPMENT AND ACCESSORIES TO
GRINDING MACHINES GR-7300 , GR-7400 AND GR-7500**DL-UNI20032****Set with industrial microscope, elongated tripod, light and monitor.**

The microscope has a clear image and high resolution
Lens: 180X C-MOUNT magnification

**Technical data:**

1. Photo / video shooting
2. Additional functions: adding guide lines, image fixation, mirroring, image rotation, digital zoom
3. Housing: aluminum alloy
4. Matrix: Panasonic
5. Matrix resolution 37.0 MP
6. Frame rate: at 1920*1080 / 60fps
7. Outputs: USB, HDMI, TF card, infrared sensor for remote control
8. Power supply: DC-12V/1A
9. Max TF card capacity: 64G
10. HDMI image resolution: 8168*6128 4:3 (50MP) 8168*4592 16:9 (37MP) (for TF card),
11. USB image resolution: 1920*1080 (for PC USB)
12. Video resolution: 1920*1080/60fps for HDMI, 1920*1080/30fps 1280*720 / 30fps 640*480 / 30fps 320*240 / 30 fps for USB
13. Video format: MP4
14. Picture format: JPG
15. Remote control
16. Language support: Russian, Chinese, English, French, Spanish, Portuguese, German, Italian, Japanese
17. Lens: 180X C-MOUNT magnification
18. Working distance: 95mm (maximum working distance 16cm)
19. Zoom Ratio: 6.5:1

Contents of delivery:

1. **DL-UNI20011** Industrial electronic microscope with power supply (HDMI / USB / AV).
2. **DL-UNI20019** Tripod holder extended for microscope
3. **DL-UNI20018** Lamp diode for a microscope
4. **DL-UNI20021** Monitor
5. **DL-UNI20022** Dedicated monitor holder on a tripod

ATTENTION! All equipment from the delivery set is sold separately!

OPTIONAL EQUIPMENT AND ACCESSORIES TO
GRINDING MACHINES GR-7300 , GR-7400 AND GR-7500**DL-UNI20200**

Stone abrasive with grain 400

**DL-UNI20201**

Stone abrasive with grain 200

**DL-UNI20202**

Stone abrasive with grain 100

OPTIONAL EQUIPMENT AND ACCESSORIES TO GRINDING MACHINES GR-7300 , GR-7400 AND GR-7500



DL-UNI20203

Stone abrasive with grain 320
with tapered profile



DL-UNI20204

Stone abrasive with grain 230
with tapered profile



DL-NG50260

Abrasive Dresser stone at an angle



OPTIONAL EQUIPMENT AND ACCESSORIES TO GRINDING MACHINES GR-7300 , GR-7400 AND GR-7500



DL-GR60007

Diamond pencil for grooving
abrasive stones (standard)



DL-GR60008

Diamond pencil for grooving
abrasive stones (reinforced)



DL-NG31309

Editing pencil
abrasive wheel (needle)



DL-GR1050

Stone holder (mandrel)



DL-GR1060

Axle for stone balancing
(Gem with holder not included)



OPTIONAL EQUIPMENT AND ACCESSORIES TO
GRINDING MACHINES GR-7300 , GR-7400 AND GR-7500**DL-GR1070**

Balancing device
(Gem with holder not included)

**DL-NG50196**

Stone remover with mandrel with spindle taper.

**DL-NG50194**

Set of drive pulleys for machine tools
GR-7300, GR-7400, GR-7500.

Material: polyurethane

Package Included:

1. **DL-NG31264** Pulley Ø15x3 for atomizer needle
2. **DL-NG31264-01** Pulley Ø15x4 for atomizer needle
3. **DL-NG31264-02** Pulley Ø15x5 for holder piezo injector valve
4. **DL-NG31196** Pulley Ø15x7 for lapping

Attention! All pulleys are also sold separately!

OPTIONAL EQUIPMENT AND ACCESSORIES TO
GRINDING MACHINES GR-7300 , GR-7400 AND GR-7500**DL-GR1080****Angle measuring kit****Contents of delivery:**

1. Protractor electronic
2. Protractor bracket
3. Protractor axis NG31249
4. A set of M4 screws - 3 pcs.

Specifications:

1. Measuring range: 0-360 degrees
2. Graduation: 0.1 degree
3. Accuracy : +-0.2 degree
4. Accuracy : 0.1 degree
5. Battery: 3V CR20032
6. Battery life: 1 year

**DL-NG31263****Gauge for setting the angle of 60 degrees****DL-NG31253****Valve holder
(pin) injectors BOSCH piezo
to polish it**

OPTIONAL EQUIPMENT AND ACCESSORIES TO GRINDING MACHINES GR-7300 , GR-7400 AND GR-7500



DL-GR1090

Measurement kit
angles of increased accuracy

Contents of delivery:

1. Protractor electronic
2. Protractor bracket
3. Protractor axis NG50205
4. A set of M4 screws - 2 pcs.

Specifications:

1. Measuring range: 0-360 degrees
2. Division value: 0.005 degrees (10 seconds)
3. Accuracy: ± 0.2 degree
4. Accuracy: 0.08 degree (± 30 seconds)
5. Working temperature range: 0 $\pm 40^{\circ}\text{C}$
6. Battery: 3V **CR20032**
7. Battery life: 1 year

*On two lines at the same time
the measurement value is displayed in
decimal degrees (upper
line) and in seconds (bottom line)*

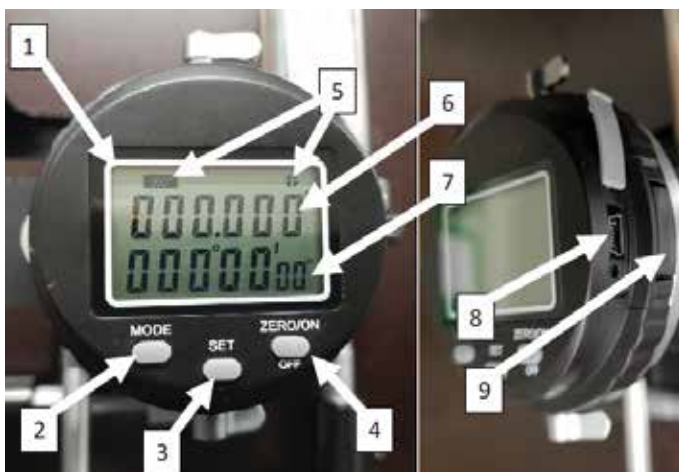

1. Display
2. MODE button
3. "SET" button
4. "ZERO / ON-OFF" button
5. Display selected measuring range (360°, 180° x 2, 90° x 4)
6. Display angle in decimal fractions of a degree.
7. Display in degrees, minutes and seconds.
8. USB socket
9. Retractable battery slot

OPTIONAL EQUIPMENT AND ACCESSORIES TO
GRINDING MACHINES GR-7300 , GR-7400 AND GR-7500**DL-NG50201****Prisms with electric motor assembly****Contents of delivery:**

1. **DL-NG50200** Prisms assemblies
2. **DL-NG31189** platform
3. **DL-NG50199** electric motor assembly
4. **DL-NG31246** Pencil holder
for editing (no pencil)
DL-NG31309 Editing pencil
5. **DL-NG31290** Stop extension bracket
6. **DL-NG31183** stop bracket standard

**DL-NG50200**

Prisms with holder assembly

**DL-NG31189**Mounting platform
prisms, electric motor and
bracket with pencil
for straightening stone.**DL-NG50199**Electric motor 12 volt
1000 rpm with protective cover
with mounting bracket and
pulley.**DL-NG31246**Editing pencil holder
abrasive stone (no pencil).
DL-NG31309 Straightening Pencil
abrasive wheel.**DL-NG31290**stop extension for
installation of long
details for their grinding.**DL-NG31183**stop bracket
workpiece
with standard length

GM-08**Surface grinding machine with bottom movable desktop.**

Designed for grinding shims, nozzle ends and other parts of fuel equipment.

**Specifications:**

Motor power	0.37 kW
Value of division	1 μ m
Working stroke of the stone	35 mm
Height length Width	505 / 370 / 340 mm
Supply voltage	~220 V \pm 15%
Tolerance of parallelism of the surface of the workpiece	0,002-0,004 mm
The weight	60 kg

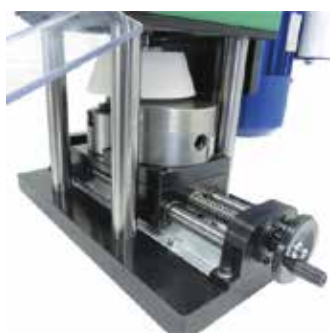
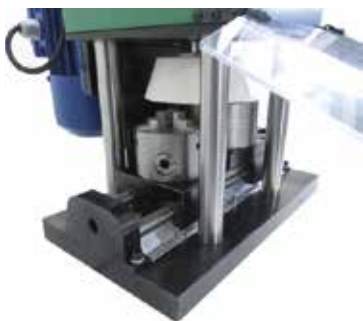

SPARE PARTS AND ACCESSORIES K
SURFACE GRINDING MACHINE GM-08**DL-UNI20205**

Grinding stone for GM-08 straight, seating diameter 20mm, outer diameter 100mm at 80grit

DL-UNI20206

Grinding stone for GM-08 straight, seating diameter 20mm, outer diameter 100mm at 60 grit

DL-UNI20207

Grinding stone for GM-08 straight, seating diameter 20mm, outer diameter 100mm at 40 grit

**DL-UNI20208**

Grinding stone for GM-08 conical, landing diameter 32mm, outer diameter 125mm at 80 grit

**DL-GM50248**

mandrel stone holder for modernized machines GM-08

**DL-GM31280**

Drive shaft with taper fit under the mandrel for the modernization of machines GM-08, issued before 04.2020.

**DL-GM50263**

Stone puller with mandrel with cone shaft.

MGM-500**Surface grinding machine with moving column**

Machine **MGM-500** is designed for grinding shims and other elements and bodies of revolution when they are fixed with a magnetic plate or clamps.

**The design of the machine includes:**

- The base housing in which the gearbox for the vertical movement of the column with grinding stone
- Electric motor with direct drive of the grinding cup
- Powerful magnet for grinding washers
- High-precision vise for trimming parts
- Protective cover
- Handle for vertical movement of the column
- Rotary handle
- Protective corrugation
- Indicator head with 0.001mm pitch
- Bracket with a cutter for straightening a stone is mounted on a protective cover

Specifications:

Vertical movement of the column	40 mm
Vise Width	50 mm
vise stroke	65 mm
stone grain	80 grit
Supply voltage	~220 V \pm 15%
Motor power	0.5 kW
Height length Width	310x260x450
Machine weight	43 kg
The number of revolutions per minute of the electric motor	2800 / 3600
Tolerance of parallelism of the surface of the workpiece	0,003-0,006 mm

**DL-CR50167****Set of CR injector holders for vise**

The block has undergone heat treatment, which increases many times its service life.

Contents of delivery:

- DL-CR31054** Universal block for vise with groove dimensions 11,12,13,19mm for installation injectors CR BOSCH and DELPHI.
- DL-CR31055** Universal block for vise with groove sizes 14,16,20 mm for installation injectors CR VOLVO, Fiat Dukato, BMW (similar to SIRINI AB0122-02)
- DL-CR31056** Universal block for vise with groove sizes 15,17,18,22 mm for installation injectors CR (similar to SIRINI AB0122-03)
- DL-CR31158** Universal block for vise with groove sizes 13, 15, 18, 22 mm for installation injectors CR PIEZO SIEMENS and BOSCH

**DL-CR50158****Set of CR injector holders for vices.**

The blocks have been heat treated, which increases many times their service life.

Contents of delivery:

- DL-CR31054** Universal block for vise with groove dimensions 11,12,13,19mm for installation injectors CR BOSCH and DELPHI.
- DL-CR31055** Universal block for vise with groove sizes 14,16,20 mm for installation injectors CR VOLVO, Fiat Dukato, BMW (similar to SIRINI AB0122-02)
- DL-CR31056** Universal block for vise with groove sizes 15,17,18,22 mm for installation injectors CR (similar to SIRINI AB0122-03)

**DL-CR31054**

Universal block for vise with slot sizes 11, 12, 13,19mm for installation of CR BOSCH injectors and DELPHI. (similar to BOSCH 0986612786, analogue SIRINI AB0122-01)

The block has undergone heat treatment, which increases many times its service life.

**DL-CR31055**

Universal block for vise with slot sizes 14, 16, 20 mm for installation of CR VOLVO injectors, FiatDukato, BMW (similar to SIRINI AB0122-02)

The block has undergone heat treatment, which increases many times its service life.

**DL-CR31056**

**Universal block for vise
with slot sizes 15, 17, 18, 22 mm
for mounting CR injectors
(similar to SIRINI AB0122-03)**

The block has undergone heat treatment,
which increases many times its service life.

**DL-CR31058**

**Universal block for vise
with slot sizes 13, 15, 18, 22 mm
for installation of CR BOSCH piezo injectors
and Siemens**

The block has undergone heat treatment,
which increases many times its service life.

**DL-UNI50043**

**Universal fixture for
clamps in the vise of CR injectors**

Clamps in two positions:

- spray up;
- spray down.

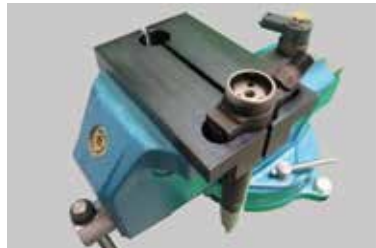
**DL-UNI50032**

**Universal fixture for
clamp in the vise of CR Denso injectors**

Clamps in two positions:

- spray up;
- spray down.

**DL-CR31093**

**Wrench for dismantling the injector solenoid
DENSO, CAT, PERKINS**

Key Features:

1. The key has 12 faces.
2. Distance between faces 27,5mm
3. Connecting square 1/2"

**DL-CR31667**

**Wrench 27 mm 1/2 for injector solenoid
DENSO**

**DL-CR31668**

**Long wrench 27 mm 1/2 for solenoid
DENSO**

**DL-UNI50046**

**Three-pin wrench for disassembly and
Denso injector assembly.**

Completeness:

- key;
- guide nut;
- drift;
- 3 additional pins.

Technological holes are provided in the key, through which you can knock out broken or worn pins and install new pins.

**DL-CR31715**

Atomizer Nut Wrench DENSO 5471 08K125157032

DL-NG50109

**Set of wrenches for mounting / dismantling nuts in
electronic part of BoschCR injectors.**

Contents of delivery:

- | | |
|-------------------|-----------------------------------------------------------------------------------------------------------------------------------------------|
| DL-CR30543 | Wrench 10-17 for mounting/dismounting the multiplier nut for BOSCH CR injectors, hexagon 10 mm with internal Ø7.5 mm wrench 17 |
| DL-CR30558 | Wrench for mounting / dismantling the nut in the electronic part of the BOSCH CR injectors, 10 mm hexagon with □1/2" square for torque wrench |
| DL-CR30561 | Wrench 10-13 for mounting / dismantling the multiplier nut for BOSCH CR injectors, hexagon 10 with internal Ø7.5 mm for a torque wrench |
| DL-CR30393 | Wrench for mounting / dismantling the nut in the electronic part of the Bosch CR injectors |

**DL-UNI50058**

Wrench 32 with teeth for mounting / dismantling the nozzle nut DELPHI trucks.

**DL-CR30545**

Wrench for mounting / dismantling the multiplier nut SIEMENS injectors

**DL-UNI30434**

Wrench for mounting / dismantling the nut of the solenoid injectors CR with dodecahedron 27 mm

**DL-UNI30435**

Wrench for mounting / dismantling the nut of the solenoid injectors CR with dodecahedron 28 mm

**DL-UNI30389**

Wrench for mounting / dismantling the solenoid nut CR injectors with hexagon 29 mm

**DL-UNI30390**

Wrench for mounting / dismantling the nut of the solenoid injectors CR with hexagon 30 mm

**DL-CR31092**

Allen key 7/8 for mounting / dismantling CR injector solenoid inner ring nut Denso. Connecting square 1/2

**DL-UNI50050**

A set of keys designed for tightening the CR injector nozzle nut any manufacturers (BOSCH, DELPHI, DENSO, Siemens).

Includes:

hexagons for 14, 15, 17, 19 mm, octahedrons 16, 17.5 mm and a 27 mm wrench for a torque handle.

**DL-UNI30384**

socket wrench with hexagon socket by 14 mm

**DL-UNI30385**

socket wrench with hexagon socket by 15 mm

**DL-UNI30386**

socket wrench with hexagon socket by 17 mm

**DL-UNI30387**

socket wrench with hexagon socket by 19 mm

**DL-UNI30388**

Key socket with internal octagon by 16 mm

**DL-UNI30692**

Key socket with internal octagon at 17.5 mm

**DL-UNI30382**

Allen key 27 mm with square hole for torque arm

**DL-UNI50054**

A set of keys designed for tightening the CR injector nozzle nut any manufacturers (BOSCH, DELPHI, DENSO, SIEMENS).

Includes:

hexagons with collar 14, 15, 17, 19 mm, octahedrons with collar 16, 17.5 mm and a 27 mm wrench for a torque handle.

**DL-UNI30460**

Nozzle wrench with inner collar hexagon 14 mm

**DL-UNI30461**

Nozzle wrench with inner collar hexagon 15 mm

**DL-UNI30459**

Nozzle wrench with shoulder internal octagon 16 mm

**DL-UNI30462**

Nozzle wrench with inner collar hexagon 17 mm

**DL-UNI30691**

Nozzle wrench with inner collar 17.5 mm octagon

**DL-UNI30463**

Nozzle wrench with inner collar hexagon 19 mm

**DL-UNI30382**

Allen key 27 mm with square hole for torque arm

**DL-CR50261**

**Mounting wrench set /
dismantling the atomizer nut for
piezo injectors BOSCH, VDO (Siemens)
and BOSCH series 111**

**DL-UNI30461**

Nozzle wrench with inner collar
hexagon 15 mm

**DL-UNI31442**

Nozzle wrench for mounting / dismantling the atomizer nut
injectors BOSCH 0445118 The key has 7 faces inside.
A 27mm wrench is used. Made from high quality
tool steel with subsequent heat treatment.

**DL-UNI30459**

Nozzle wrench with shoulder
internal octagon 16 mm

**DL-UNI31395**

Nozzle wrench for mounting / dismantling the atomizer nut
injectors BOSCH 0445118 The key has 8 protrusions inside.
A 27mm wrench is used. Made from high quality
tool steel with subsequent heat treatment.

**DL-UNI31394**

Nozzle wrench for mounting / dismantling the atomizer nut
nozzles VDO (SIEMENS) PCRs5 Has an internal 9-sided face.
A 27mm wrench is used. Made from high quality
tool steel with subsequent heat treatment.

**DL-UNI31435**

Nozzle wrench for mounting / dismantling the atomizer nut
injectors BOSCH 111 series. The key has 10 projections inside.
Used turnkey 27mm. Made from high quality
tool steel with subsequent heat treatment.
Durability is guaranteed.

**DL-UNI30382**

Allen key 27 mm with square
hole for torque arm

**DL-CR50262**

**Mounting wrench set /
dismantling the nozzle spray nut**
Common Rail BOSCH, VDO (Siemens), DENSO,
DELPHI of all types.

**DL-UNI30460**

Nozzle wrench with inner collar
hexagon 14 mm

**DL-UNI30461**

Nozzle wrench with inner collar
hexagon 15 mm

**DL-UNI30462**

Nozzle wrench with inner collar
hexagon 17 mm

**DL-UNI30814**

socket wrench with hexagon socket
18 mm for BOSCH electromagnetic injectors

**DL-UNI30463**

Nozzle wrench with inner collar
hexagon 19 mm

**DL-UNI31442**

Nozzle wrench for mounting / dismantling the atomizer nut
injectors BOSCH 0445118 The key has 7 faces inside.
A 27mm wrench is used. Made from high quality
tool steel with subsequent heat treatment.

**DL-UNI31288**

Key socket with internal octahedron
15 mm for BOSCH electromagnetic injectors

**DL-UNI30459**

Nozzle wrench with shoulder
internal octagon 16 mm

**DL-UNI30691**

Nozzle wrench with inner collar
17.5mm octagon

**DL-UNI31395**

Nozzle wrench for mounting / dismantling the atomizer nut
injectors BOSCH 0445118 The key has 8 protrusions inside.
A 27mm wrench is used. Made from high quality
tool steel with subsequent heat treatment.

**DL-UNI31394**

Nozzle wrench for mounting / dismantling the atomizer nut
nozzles VDO (SIEMENS) PCRs5 Has an internal 9-sided face.
A 27mm wrench is used. Made from high quality
tool steel with subsequent heat treatment.

**DL-UNI31435**

Nozzle wrench for mounting / dismantling the atomizer nut
injectors BOSCH 111 series. The key has 10 projections inside.
A 27mm wrench is used. Made from high quality
tool steel with subsequent heat treatment.
Durability is guaranteed.

**DL-UNI30382**

Allen key 27 mm with square
hole for torque arm

**DL-UNI50105**

Set of hex wrenches for
25,27,29,30 mm square
hole for dyno
handle or wrench 1/2"

**DL-UNI30803**

24 mm hex wrench with square
hole for torque arm
or wrench 1/2"

**DL-UNI30382**

27 mm hex wrench with square
hole for torque arm
or wrench 1/2"

**DL-UNI30541**

29 mm hex wrench with square
hole for torque arm
or wrench 1/2"

**DL-UNI30625**

30 mm hex wrench with square
hole for torque arm
or wrench 1/2"

**DL-CR30814**

Nut wrench (18) for mounting / dismantling
CR SCANIA injector nozzle nuts 1881565
The key has 6 faces with a width of 18mm

**DL-CR30816**

Wrench 2V for mounting / dismantling the nut
injector solenoid CR SCANIA 1881565

**DL-CR30815**

Wrench 16Z for mounting / dismantling the toothed nut
injector CR SCANIA 1881565

**DL-CR50119**

Set of keys for disassembly /
injector assembly CR SCANIA 1881565

Kit includes:

- key DL-CR30814
- key DL-CR30815
- key DL-CR30816

**DL-CR30843**

Key - nozzle for convenient and safe
dismantling the piezo injector tube
(turnkey 27 mm).
Prevents breakage of the return fitting
drain nozzle

**DL-UIS30767**

Nozzle test adapter
CR injectors Delphi Smart(1725282).

**DL-UNI50039**

Wrench for mounting / dismantling the spray nut
Ø 20.9 mm Delphi Smart nozzles
(for torque wrench)

**DL-UNI50131**

Wrench for mounting / dismantling the spray nut
Ø 25.8mm nozzles CR Bosch
(for torque wrench)

**DL-CR31095**

Wrench for mounting / dismantling the internal
ring-nuts for Denso, CAT, Perkins injectors.

**DL-CR50148**

Valve Installer
CRIN injectors

**DL-CR50154**

Valve removal tool
injector multiplier CRIN M19 x 0.75mm

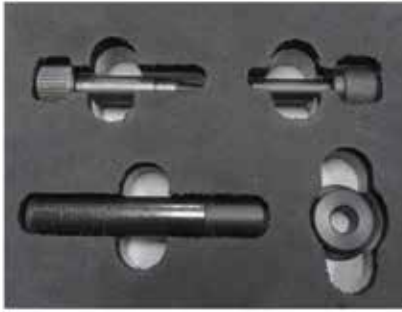
**DL-CR50104**

**Seal removal and installation kit
rings and valve settings for CR injectors**

- DL-CR31553** Pusher (Ø 9.4mm x 7.4mm) for installation O-ring for BOSCH CRIN 3-18 injectors
- DL-CR30756** Guide sleeve (Ø 10mm)
- DL-CR30755** Pusher for valve installation (Ø 15.5mm)
- DL-CR30753** Extractor for old O-rings Organizer.

**DL-CR50298**

**Seal removal and installation kit
rings and valve settings for CR injectors**

- DL-CR31553** Pusher (Ø 9.4mm x 7.4mm) for installation O-ring for BOSCH CRIN 3-18 injectors
- DL-CR30756** Guide sleeve (Ø 10mm)
- DL-CR30755** Pusher for valve installation (Ø 15.5mm)
- DL-CR30754** Pusher (Ø 10mm x 7.6mm) for installation O-ring for BOSCH CRI injectors
- DL-CR30753** Extractor for old O-rings Organizer.

DL-CR50172

**Set of accessories for installing paronite
CRIN injector rings**

Contents of delivery:

**DL-CR50153**

**Device for installing paronite
CRIN injector rings**

Collet outer diameter 6.5mm
Connecting thread M18x0.75mm
Analog BOSCH 0986613648
Analog SIRINI AAZ034-648

**DL-CR50155**

**Device for installing paronite
CRIN injector rings**

Collet outer diameter 7.5mm
Connecting thread M18x0.75mm
Analog BOSCH 0986613646
Analog SIRINI AAZ034-646

**DL-CR50170**

**Device for installing paronite
CRIN injector rings**

Collet outer diameter 7.5mm
Connecting thread M17x1mm
Analog BOSCH 0986613640
Analog SIRINI AAZ034-640

ATTENTION! All fixtures are sold separately.

**DL-CR50308**

Adapter for pressing in O-rings injectors CRI1/CRI2
Consists of guide nut **DL-CR31579** and pusher **DL-CR31578**.

**DL-CR50305**

Extractor (collet) for dismantling valve seats CRI/CRIN1

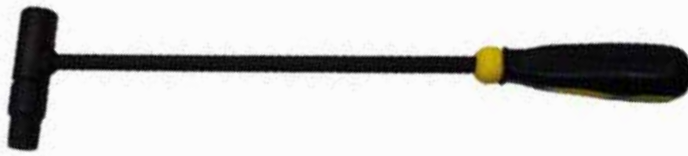
**DL-CR50317**

Needle extractor nozzle sprayer

DL-CR50245**Filter extraction and installation kit injectors DENSO CR****Contents of delivery:**

1. M14 adapter - 2 pcs.
2. M12 adapter - 2 pcs.
3. Collet clamp - 1 pc.
4. Collet for collet clamp - 1 pc.
5. Threaded stud - 2 pcs.
6. Tap - 2 pcs.
7. Extractor for extracting the filter - 1 pc.
8. Pusher for filter installation - 1 pc.

DL-CR50300**Set of cutters for cleaning engine seats
injectors Delphi, Bosch****Applicability:**

- Bosch common rail Piezo
- Common rail Daily
- Pump injector Volkswagen Audi
- Tector and Man nozzles



D-07147122

Torque wrench 1/2"
25-100 Nm



D-07147121

Torque wrench 3/8"



D-07147120

Torque wrench 1/4"
0-20 Nm



DL-UNI30776

Adapter with 1/4" internal square
and outer square 1/2"



DL-UNI31593

Adapter with vnutr. 3/8" square
and outer square 1/2"

**DL-UNI50327**

Double-sided pneumatic puller for removing the injectors from the engine car

Kit includes two mounting adapters nozzles: DL-CR30542 with thread M17x1 to M14x1.5; DL-CR30984 with thread M20x1.5 to M14x1.5

**DL-UNI50334**

One-sided pneumatic puller for removing the injectors from the engine car

Kit includes two mounting adapters nozzles: DL-CR30542 with thread M17x1 to M14x1.5; DL-CR30984 with thread M20x1.5 to M14x1.5

**DL-UNI50049**

Puller for extracting CR injectors Bosch from the engine head.

There are two ways to remove injectors: using a hydraulic jack and using reverse hammer.

**DL-CR50197**

Puller (device for dismantling) BOSCH injectors from the engine.

Suitable for extracting injectors BOSCH with internal thread M17x1 and external thread M27x1

There are two ways to remove injectors: with the help of a hydraulic jack and with the help of reverse hammer.

**DL-CR50337**

Nozzle Puller Kit for Ssang Yong Kyron

The puller consists of three elements: housing, nut, screw. The kit also includes 2 remote bushings of different heights.



DL-CR30542

Internal puller for CR injectors
with thread M17x1 and M14x1.5



DL-CR31077

Puller for CR injectors with internal
thread M14x1.5 and external thread M14x1.5



DL-CR30984

Internal puller for injectors
CR Denso 23670-OR010 Threaded
M20x1 and M14x1.5



DL-CR30990

Internal puller for injectors
CR Siemens with M25x1 and M14x1.5 threads



DL-UNI50060

Impact puller 340 mm long



DL-CR50059

Puller for CR injectors
with M27x1 thread



DL-CR31600

Puller for removing DENSO
injectors from the engine



D-CER50500

Non-stick ceramic paste
Pasta in a tube 50 gr.

**DL-UNI50062**

Measurement adapter compression in diesel engines (M12x1.5; stem L=175 mm).

Installed in place of the injector.

The pressure sensor is not included.

DL-UNI20008

Compression test kit in diesel engines.

Kit includes:

- adapter **DL-UNI50062** – 1 pc.
- Pr-tester - 1pc;
- cable for pressure sensor – 1 pc.

The pressure sensor is not included.

**Appearance and scope of delivery subject to change to improve equipment performance*

**DL-UNI20000**

Compression test kit in diesel engines.

Kit includes:

- adapter **DL-UNI50062** – 1 pc.
- Pr-tester - 1pc;
- cable for pressure sensor – 1 pc.
- pressure sensor up to 150 bar or 200 bar

**DL-CR10045**

**Pressure sensor 150 bar
for the compressor DL-UNI20008**

**DL-CR10046**

**Pressure sensor 250 bar
for the compressor DL-UNI20008**

**DL-PR363**

Compressor kit for diesel engines

The kit includes:

- Recording compressograph — 1 pc,
- Instruction — 1 pc,
- Quick — release adapter M14x1.5 - 1 pc,
- Adapter M14x1.5 — 1 pc,
- Adapter M12x1.5 — 1 pc,
- Spare cards — 1 k-t,
- Case — 1 pc.

**DL-WT04A3021**

**Fuel pressure measuring kit
in the low pressure line in diesel
and gasoline engines.**

Measuring range 0-140 psi (0-10 bar)

**DL-KIP0001****Mechanical dial gauge****Characteristics :**

- Type - mechanical
- Stroke - 10mm
- Resolution - 0.01 mm
- Repeatability - 0.01 mm

**DL-KIP0002****Mechanical dial gauge****Characteristics :**

- Type - mechanical
- Stroke - 5 mm
- Resolution - 0.001 mm
- Repeatability - 0.001 mm

**DL-KIP0003****Mechanical dial gauge****Characteristics :**

- Type - mechanical
- Stroke - 5 mm
- Resolution - 0.01 mm
- Repeatability - 0.02 mm

**DL-KIP0004****Mechanical dial gauge****Characteristics :**

- Type - mechanical
- Stroke - 10 mm
- Resolution - 0.01 mm
- Repeatability - 0.02 mm

**DL-KIP0005****Mechanical dial gauge****Characteristics :**

- Type - mechanical
- Stroke - 20 mm
- Resolution - 0.01 mm
- Repeatability - 0.03 mm

**DL-KIP0006****Mechanical dial gauge****Characteristics :**

- Type - mechanical
- Stroke - 30mm
- Resolution - 0.01 mm
- Repeatability - 0.03 mm

**DL-KIP0007****Mechanical dial gauge****Characteristics :**

- Type - mechanical
- Stroke - 50 mm
- Resolution - 0.01 mm
- Repeatability - 0.04 mm

**DL-KIP0008****Indicator measuring head****Characteristics :**

- Type - mechanical
- Stroke - 25 mm
- Resolution - 0.01 mm
- Repeatability - 0.02 mm

**DL-KIP0010****Indicator measuring head****Characteristics :**

- Type - electronic
- Stroke - 12.7mm
- Resolution - 0.01 mm
- Repeatability - 0.01 mm
- Sleeve - 8 mm
- Automatic shutdown

**DL-KIP0011****Indicator measuring head****Characteristics :**

- Type - electronic
- Stroke - 12.7mm
- Resolution - 0.001 mm
- Repeatability - 0.004 mm
- Sleeve - 8 mm
- Automatic shutdown

**DL-KIP0012****Indicator measuring head****Characteristics :**

- Type - electronic
- Stroke - 25 mm
- Resolution - 0.001 mm
- Repeatability - 0.004 mm
- Sleeve - 8 mm
- Automatic shutdown

**DL-KIP0015 Limit****Indicator measuring head****Characteristics :**

- Type - electronic
- Stroke - 12.5 mm
- Resolution - 0.01 mm
- Repeatability - 0.03 mm
- Sleeve - 8 mm
- Automatic shutdown

**DL-KIP0016 Limit****Indicator measuring head****Characteristics :**

- Type - electronic
- Stroke - 12.5 mm
- Resolution - 0.001 mm
- Repeatability - 0.004 mm
- Sleeve - 8 mm
- Automatic shutdown

**DL-KIP0019 TESA****Indicator measuring head****Characteristics :**

- Type - electronic
- Stroke - 12.7mm
- Resolution - 0.01 mm
- Repeatability - 0.01 mm
- Sleeve - 8 mm
- Automatic shutdown

**DL-KIP0020 TESA****Indicator measuring head****Characteristics :**

- Type - electronic
- Stroke - 12.7mm
- Resolution - 0.001 mm
- Repeatability - 0.002 mm
- Sleeve - 8 mm
- Automatic shutdown

**DL-KIP0021 TESA****Indicator measuring head****Characteristics :**

- Type - electronic
- Stroke - 25 mm
- Resolution - 0.001 mm
- Repeatability - 0.002 mm
- Sleeve - 8 mm
- Automatic shutdown

**DL-KIP0023 Dieselland****Measuring communication key
PC heads****DL-KIP0025 Eee****Indicator measuring head****Characteristics :**

- Type - electronic
- Stroke - 12.7mm
- Resolution - 0.001 mm
- Repeatability - 0.002 mm
- Sleeve - 8 mm
- Automatic shutdown

**DL-KIP0026 Eee****Indicator measuring head****Characteristics :**

- Type - electronic
- Stroke - 25 mm
- Resolution - 0.001 mm
- Repeatability - 0.004 mm
- Sleeve - 8 mm
- Automatic shutdown

**DL-KIP0028 Eee****Measuring communication key
PC heads**

**DL-KIP0029** **SHAHE****Indicator measuring head****Characteristics :**

- Type - electronic
- Stroke - 12.7mm
- Resolution - 0.001 mm
- Repeatability - 0.002 mm
- Sleeve - 8 mm
- Automatic shutdown
- Communication with a PC using a COM port (cable included)

**DL-KIP030** **SHAHE****Indicator measuring head****Characteristics :**

- Type - electronic
- Stroke - 12.7mm
- Resolution - 0.001 mm
- Repeatability - 0.002 mm
- Sleeve - 8 mm
- Automatic shutdown

**DL-KIP0031** **SHAHE****Indicator measuring head****Characteristics :**

- Type - electronic
- Stroke - 25 mm
- Resolution - 0.001 mm
- Repeatability - 0.004 mm
- Sleeve - 8 mm
- Automatic shutdown

**DL-KIP0032** **Eee****Indicator measuring head****Characteristics :**

- Type - electronic
- Stroke - 50 mm
- Resolution - 0.001 mm
- Repeatability - 0.005 mm
- Sleeve - 8 mm
- Automatic shutdown

**DL-KIP0034**

Indicator digital measuring head with an accuracy of 0.01 mm, stroke 12.5 mm

Characteristics :

- Type - electronic
- Resolution - 0.01mm
- Accuracy - 0.01mm
- Large, high contrast LCD display
- Carbide tip, thread - M2.5
- Sleeve - 8mm
- Automatic shutdown
- Case Ø – 60mm

**DL-KIP0035**

Indicator digital measuring head with an accuracy of 0.001 mm, stroke 12.5 mm

Characteristics :

- Type - electronic
- Measuring range - 12.7mm
- Resolution - 0.001mm
- Accuracy - 0.002mm
- Large, high contrast LCD display
- Carbide tip, thread - M2.5
- Sleeve - 8mm
- Automatic shutdown
- Case Ø – 60mm

**DL-KIP0036**

Indicator digital measuring head with an accuracy of 0.001 mm, stroke 25mm

Characteristics :

- Type - electronic
- Measuring range - 25.4mm
- Resolution - 0.001mm
- Accuracy - 0.004mm
- Large, high contrast LCD display
- Carbide tip, thread - M2.5
- Sleeve - 8mm
- Automatic shutdown
- Case Ø – 60mm

**DL-KIP0037**

Digital thickness gauge 0-12.7 mm, 0.001 mm

Characteristics :

- Measuring range - 0-12.7 mm
- Resolution - 0.001 mm
- LCD display
- Automatic shutdown
- Case Ø – 57 mm

**DL-KIP0250****Magnetic stand for mounting indicator measuring head**

The stand base has high magnetic properties, which allows installation both on horizontal as well as vertical surfaces.

ATTENTION!

The measuring head is not included in the scope of delivery!

**DL-KIP0251****Magnetic stand for mounting indicator measuring head**

The stand base has high magnetic properties, which allows installation both on horizontal as well as vertical surfaces.

ATTENTION!

The measuring head is not included in the scope of delivery!

**DL-STC150**

digital caliper

**DL-M030***(limited quantity)***Digital micrometer**

Measuring range 0-25mm

Measurement accuracy 0.001mm

**DL-M035****Digital micrometer**

Measuring range 0-25mm

Measurement accuracy 0.001mm

**DL-M040****D-SDM
tripod for digital
micrometer****D-DMTS-KIT***(limited quantity)***Kit DL-030 with DL-040.****Tripod and digital micrometer**



CR-NEXT-ST01

Special table-workbench
with two drawers

Included:

- Table with two drawers
- Wall perforated for tool placement
- Lighting ramp with two holders
- Shelf for PC
- Shelf for signal generator



D-KMD

Container for cleaning small
parts in an ultrasonic bath.



D-1012020001

Stainless steel bath
320x260



D-101340001

Stainless steel bath
320x170



D-UV10

ultrasonic bath
capacity 10 liters



D-UV05

ultrasonic bath
capacity 5 liters



D-UV9.5K

ultrasonic bath
capacity 9.5 liters



D-UV9.5R

ultrasonic bath
capacity 9.5 liters



D-UV9.5R

ultrasonic bath
capacity 5.7 liters



DL-AP2

Set of 2 anti-magnetic
tweezers



0503-03

High magnification lens
backlit



DL-MO

optical microscope



DL-MV200UM

Digital microscope

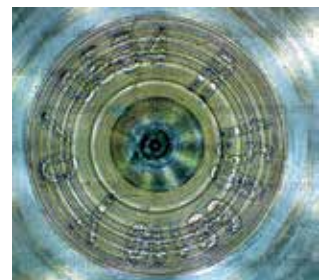

DL-UNI20015**Set with industrial microscope,
tripod and lighting.**

The microscope has a clear image and high resolution.

**Technical data:**

1. The magnification of the microscope: 8x-130x
2. Working distance : 50-200mm
3. Connecting to a monitor via ports: (HDMI/VGA).
4. Microscope size (width x length): 40mm x 115mm

Contents of delivery:

1. **DL-UNI20016** Industrial electronic microscope with power supply (HDMI / VGA).
2. **DL-UNI20017** tripod holder for microscope
3. **DL-UNI20018** Lamp diode for a microscope.

ATTENTION! All equipment from the delivery set is sold separately!



DL-UNI20020**Set with industrial microscope,
extended tripod and backlight.**

The microscope has a clear image and high resolution.

**Technical data:**

1. The magnification of the microscope: 8x-130x
2. Working distance : 50-200mm
3. Connecting to a monitor via ports: (HDMI/VGA).
4. Microscope size (width x length): 40mm x 115mm

Contents of delivery:

1. **DL-UNI20016** Industrial electronic microscope with power supply (HDMI / VGA).
2. **DL-UNI20019** Tripod holder extended for microscope
3. **DL-UNI20018** Lamp diode for a microscope.

ATTENTION! All equipment from the delivery set is sold separately!



DL-UNI20025

Set with industrial microscope, elongated tripod, light and monitor.

The microscope has a clear image and high resolution.

**Technical data:**

1. The magnification of the microscope: 8x-130x
2. Working distance : 50-200mm
3. Connect to monitor via ports: HDMI/VGA
4. Microscope size (width x length): 40mm x 115mm

Contents of delivery:

1. **DL-UNI20016** Industrial electronic microscope with power supply (HDMI / VGA / AV).
2. **DL-UNI20019** Tripod holder extended for microscope
3. **DL-UNI20018** Lamp diode for a microscope.
4. **DL-UNI20021** Monitor.
5. **DL-UNI20022** Dedicated monitor holder on a tripod.

ATTENTION! All equipment from the delivery set is sold separately!



DL-UNI20030

Set with industrial microscope, elongated tripod, light and monitor.

The microscope has a clear image and high resolution.

**Technical data:**

1. The magnification of the microscope: 8x-130x
2. Working distance : 50-200mm
3. Connect to monitor via ports: HDMI/VGA
4. Microscope size (width x length): 40mm x115mm

Contents of delivery:

1. **DL-UNI20010** Industrial electronic microscope with power supply (HDMI / USB / AV).
2. **DL-UNI20019** Tripod holder extended for microscope
3. **DL-UNI20018** Lamp diode for a microscope.
4. **DL-UNI20021** Monitor.
5. **DL-UNI20022** Dedicated monitor holder on a tripod.

ATTENTION! All equipment from the delivery set is sold separately!



DL-UNI20026

Комплект с микроскопом промышленным, удлиненным штативом , подсветкой и монитором.

Микроскоп имеет четкое изображение и высокое разрешение.

**Технические данные:**

1. Кратность увеличения микроскопа: 5x-100x
2. Рабочее расстояние : 50-170 мм
3. Подключение к монитору через порты: HDMI
4. Размер микроскопа (ширина x длина): 40мм x 115мм

Комплект поставки:

1. **DL-UNI20013** Микроскоп электронный промышленный с блоком питания и лампой подсветки (HDMI / USB).
2. **DL-UNI20019** Штатив держатель удлиненный для микроскопа
3. **DL-UNI20021** Монитор.
4. **DL-UNI20022** Специальный держатель монитора на штативе.

ВНИМАНИЕ! Все оснащение из комплекта поставки продается в том числе и отдельно!



DL-UNI20027**Set with industrial microscope, elongated tripod, light and monitor.**

The microscope has a clear image and high resolution.

**Technical data:**

1. The magnification of the microscope: 10x-180x
2. Working distance : 100-150mm
3. Connect to monitor via ports: HDMI
4. Microscope size (width x length): 40mm x115mm

Contents of delivery:

1. **DL-UNI20014** Industrial electronic microscope with power supply (HDMI / USB / AV).
2. **DL-UNI20019** Tripod holder extended for microscope
3. **DL-UNI20018** Lamp diode for a microscope.
4. **DL-UNI20021** Monitor.
5. **DL-UNI20022** Dedicated monitor holder on a tripod.

ATTENTION! All equipment from the delivery set is sold separately!



DL-UNI20031**Microscope kit HDMI USB 1080P
FHD 48MP x 200**

The microscope has a clear image and high resolution
Lens: 200X C-MOUNT magnification

**Technical data:**

1. Photo / video shooting
2. Additional functions: adding guide lines, image fixation, mirroring, image rotation, digital zoom
3. Housing: aluminum alloy
4. Matrix: Panasonic
5. Matrix resolution 48 MP
6. Frame rate: at 1920*1080 / 60fps
7. Outputs: USB, HDMI, TF card, infrared sensor for remote control
8. Power supply: DC-12V/1A
9. Max TF card capacity: 64G
10. HDMI image resolution: 8168*6128 4:3 (50MP) 8168*4592 16:9 (37MP) (for TF card),
11. USB image resolution: 1920*1080 (for PC USB)
12. Video resolution: 1920*1080/60fps for HDMI, 1920*1080/30fps 1280*720 / 30fps 640*480 / 30fps 320*240 / 30 fps for USB
13. Video format: MP4
14. Picture format: JPG
15. Remote control
16. Language support: Russian, Chinese, English, French, Spanish, Portuguese, German, Italian, Japanese
17. Lens: 200X C-MOUNT magnification
18. Working distance: 95mm (maximum working distance 16cm)
19. Zoom Ratio: 6.5:1

Contents of delivery:

1. **DL-UNI20023** Microscope electronic promiscuous with power supply (HDMI / USB / AV)
2. **DL-UNI20019** Tripod holder extended for microscope
3. **DL-UNI20018** Lamp diode for a microscope
4. **DL-UNI20021** Monitor
5. **DL-UNI20022** Dedicated monitor holder on a tripod

ATTENTION! All equipment from the delivery set is sold separately!

DL-UNI20032**Комплект с микроскопом промышленным, удлиненным штативом, подсветкой и монитором.**

Микроскоп имеет четкое изображение и высокое разрешение
Объектив: увеличение 180X C-MOUNT

**Технические данные:**

1. Фото / видео съемка
2. Дополнительные функции: добавление вспомогательных линий, фиксация изображения, зеркальное отображение, вращение изображения, цифровой зум
3. Корпус: алюминиевый сплав
4. Матрица: Panasonic
5. Разрешение матрицы 37.0 MP
6. Частота кадров: при 1920*1080 / 60 кадров в секунду
7. Выходы: USB, HDMI, tf-карта, инфракрасный датчик для пульта дистанционного управления
8. Питание: DC-12V / 1A
9. Максимальный объем tf-карты: 64G
10. Разрешение изображения HDMI: 8168*6128 4:3 (50MP) 8168*4592 16:9 (37MP) (для tf-карты),
11. Разрешение изображения USB: 1920*1080 (для ПК USB)
12. Разрешение видео: 1920*1080 / 60 кадров в секунду для HDMI, 1920*1080 / 30 кадров в секунду 1280*720 / 30 кадров в секунду 640*480 / 30 кадров в секунду 320*240 / 30 кадров в секунду для USB
13. Формат видео: MP4
14. Формат изображения: JPG
15. Дистанционное управление
16. Поддержка языков: русский, китайский, английский, французский, испанский, португальский, немецкий, итальянский, японский
17. Объектив: увеличение 180X C-MOUNT
18. Рабочее расстояние: 95 мм (максимальное рабочее расстояние 16 см)
19. Коэффициент масштабирования: 6,5: 1

Комплект поставки:

1. **DL-UNI20011** Микроскоп электронный промышленный с блоком питания (HDMI / USB / AV).
2. **DL-UNI20019** Штатив держатель удлиненный для микроскопа
3. **DL-UNI20018** Лампа диодная для микроскопа.
4. **DL-UNI20021** Монитор.
5. **DL-UNI20022** Специальный держатель монитора на штативе.

ВНИМАНИЕ! Все оснащение из комплекта поставки продается в том числе и отдельно!

**DL-UNI20017**

Штатив держатель для
микроскопа

**DL-UNI20019**

Штатив держатель удлиненный
для микроскопа

**DL-UNI20022**

Держатель монитора монитора на штативе
Посадочный диаметр 25мм.

**DL-UNI20021**

Монитор

Комплект поставки:

1. Монитор
2. Кабель HDMI
3. Кабель BNC
4. Кабель AV
5. Пульт управления
6. Блок питания
7. Кронштейн
8. Кабель VGA
9. Прокладка



Монитор



Кабель HDMI



Кабель BNC



Кабель AV



Пульт управления



Блок питания



Кронштейн



Кабель VGA

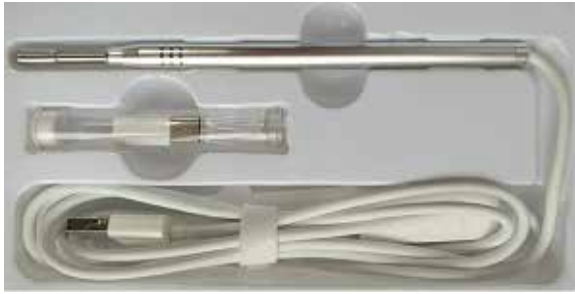

Прокладка

**DL-UNI20012**

Endoscope Camera 3.9mm

Specifications:

1. Camera resolution: 1.0 Megapixel (FHD)
2. Field of view: 70°
3. Diameter: 3.9mm
4. Length of the thin part: 25mm
5. Total length: 140mm
6. Backlight: 6 high brightness LEDs
7. Waterproof case
8. Two types of connection ports: USB / Type-c
9. Ability to adjust the backlight
10. Ability to save photos
11. Ability to install software on the phone and PC

**DL-UNI20100**Control stand for test benches
injectors and injection pump**Benefits of this stand:**

The stand can move across the floor for fixed wheels.

The rack can mount a PC with keyboard and monitor or laptop. There is a shelf at the bottom of the rack for a printer that closes with a door with polycarbonate glass.

Printer safety door retracts inside the rack, which creates additional convenience for accessing the printer.

There are two shelves in the middle of the rack for installation of control devices for various fuel systems.

Provides convenient access to everything equipment installed on this control stand.

Specifications:

- rack weight 80 kg
- overall dimensions mm (width x depth x height) 500x500x1600
- weight load kg. 160

**DL-RP400****Manual press for injector testing with mechanical pressure gauge****Contents of delivery:**

- mechanical press - 1 pc.
- mechanical pressure gauge - 1 pc.
- connecting tube – 2 pcs.

**DL-RP410 (without pressure sensor)****DL-RP415 (with pressure sensor. 1500 bar)****Manual press for injector testing with electronic pressure gauge****Contents of delivery:**

- mechanical press - 1 pc.
- connecting tube – 2 pcs.
- electronic pressure gauge with cable – 1 pc.
- battery charger - 1 pc.
- pressure sensor (for **RP 415**) for 1500 bar – 1 pc.

**DL-RP420 (without pressure sensor)****DL-RP425 (with pressure sensor. 1500 bar)****Manual press for injector testing with 2-channel electronic pressure gauge****Contents of delivery:**

- mechanical press - 1 pc.
- connecting tube – 2 pcs.
- electronic pressure gauge with cable – 1 pc.
- battery charger - 1 pc.
- pressure sensor (for **RP 425**) for 1500 bar – 1 pc.

**DL-RP430****Manufacturer - ZECA (Italy)
Flame test chamber (aspirator)
nozzle spray**

Allows for visual inspection performance of diesel injectors without harm to health.

The device is going to work liquid for reuse.

**DL-RP500**

Manufacturer - ZECA (Italy)
**Manual press for injector testing
 with mechanical pressure gauge**

Contents of delivery:

- mechanical press - 1 pc.
- mechanical pressure gauge - 1 pc.
- connecting tube - 2 pcs.



DL-RP510 (without pressure sensor)

DL-RP515 (with pressure sensor. 1500 bar)

**ZECA hand press for injector testing
 with electronic pressure gauge**

Contents of delivery:

- mechanical press - 1 pc.
- connecting tube – 2 pcs.
- electronic pressure gauge with cable – 1 pc.
- battery charger - 1 pc.
- pressure sensor (for RP 515) for 1500 bar – 1 pc.



DL-RP520 (without pressure sensor)

DL-RP525 (with pressure sensor. 1500 bar)

**ZECA hand press for injector testing
 with 2-channel electronic pressure gauge**

Contents of delivery:

- mechanical press - 1 pc.
- connecting tube – 2 pcs.
- electronic pressure gauge with cable – 1 pc.
- battery charger - 1 pc.
- pressure sensor (for RP 525) for 1500 bar – 1 pc.

PUMP TEST.02

Common-Rail High Pressure Pump Testing Equipment



В состав комплекта входит: The kit includes:

1. The **PTC-2520** device is designed to provide user-programmable control signals to Common Rail injection pump pressure regulators to test their performance.
2. Device **FMDE-520**, designed to measure the performance of the Common-Rail injection pump in two channels.
3. Tool rack on wheels for easy operation.
4. A set of adapter cables.
5. Liquid fine filters (2 pcs.)
6. Software.





PTC-2520 CP TESTER

Device for testing and testing high-pressure fuel pumps of the Common Rail system with a set of cables.

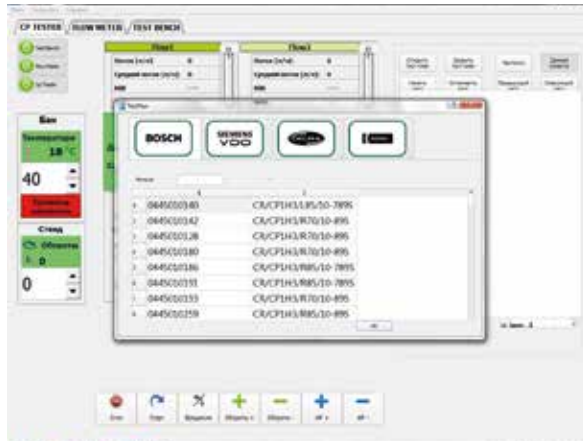

FMDE-520

Device for testing the performance of fuel pumps of the Common Rail system of various manufacturers: Bosch, Delphi, Denso, Siemens, Cummins on a test bench.

It is a 2-channel liquid flow meter (pump supply and return discharge) in various modes, with digital information output to a backlit liquid crystal display.



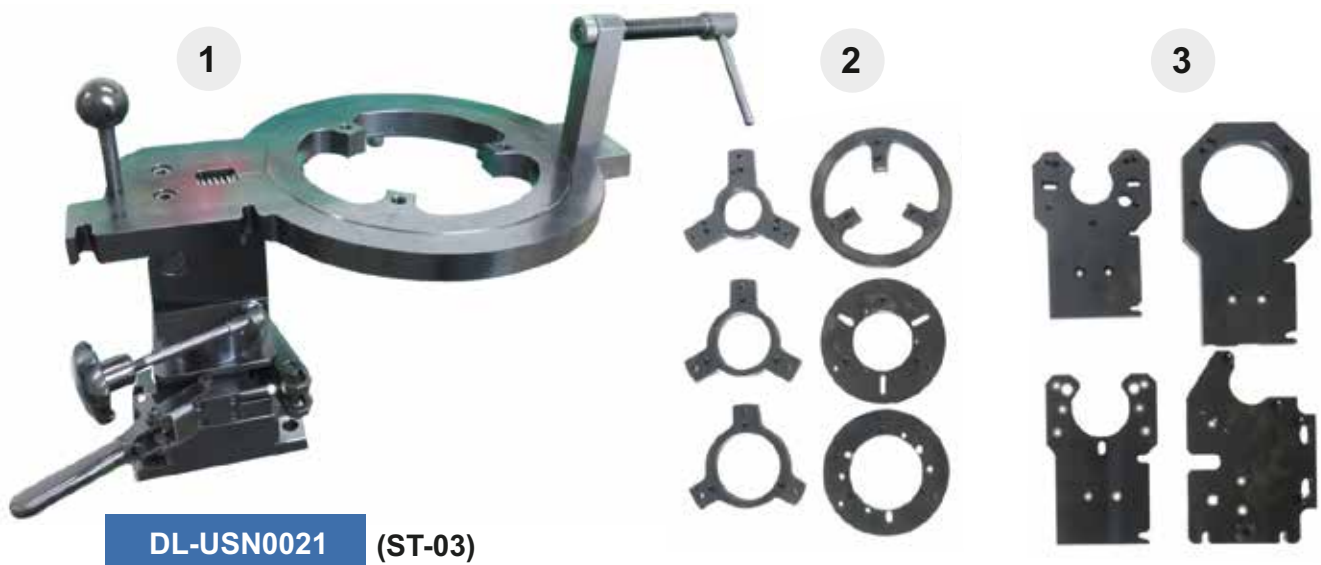

DL-USN0021 (ST-03)

Universal cradle for CR pumps

Delivery set DL-USN0021 (ST-03):

1. Rotary stand - 1 pc.
2. Set of flanges for fastening CR pumps of 6 pcs.
3. Set of 4 pump support plates.

Delivery set DL-USN0021CR (ST-03CR):

1. Rotary stand - 1 pc.
2. Set of flanges for fastening CR pumps of 6 pcs.

ATTENTION!

Holder plates for high pressure fuel pumps CR and rotary high pressure fuel pumps are also sold separately!



FLANGES

**DL-UNI30474**

Mounting flange
for injection pump CP3 MAN,
equivalent to Bosch
1685720258

**DL-UNI30884**

Mounting flange
for injection pump MAN
CP3.4 analog
Bosch 1685720312

**DL-UNI30464**

Mounting flange
for injection pump CR (MB)

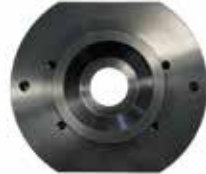
**DL-CR31607**

Mounting flange
for injection pump DENSO
HP0 094000-0635

**DL-UNI30465**

Mounting flange
for injection pump CR (BMW,
RENAULT, MB, Peugeot)

**DL-CR30860**

Mounting flange
for injection pump CR
DENSO HP2 , HP3.

**DL-CR30466**

Mounting flange 68 mm,
for injection pump CR Renault
Megane, Delphi Siemens
VDO, Land Rover,
RangeRoverV8 and for
HPFP VE

**DL-CR30861**

Mounting flange
50 mm for injection pump CR
CP4. (AAE001-CP4)

**DL-UNI30428**

Mounting flange
107 mm for injection pump
CP3 Bosch.

**DL-CR30862**

Mounting flange 50 mm
for injection pump CR CP4HS2
Bosch0445010637,
Bosch0445010506.

**DL-UNI31739**

Mounting flange for
Fuel injection pump AZPI
A-08-013-10, 708,
BOSCH 0445020224

**DL-UNI30886**

Mounting flange
for injection pump 107 mm
CP2 Bosch 0445020036
(Renault).

**DL-UNI50008**

Bracket for pumps,
Bosch standard 125 mm.
Installed on a stand.



DL-CR31145

Mounting flange 80mm
for injection pump CR CP3S3
Bosch 0445020060



DL-CR50159

Mounting stand
HPFP SIEMENS



DL-CR31150

Flange for mounting on
stand injection pump CR DELPHI with
bore diameter 50 mm
and mounting holes
perpendicular
to the plane of the bore.



DL-UNI30887

Mounting flange
HPFP CRCP3 Mercedes,
(Similar to SIRINI
AAE001-03)



DL-CR31165

High pressure fuel pump
mounting flange
BOSCH CR / CP1H3 60mm
For example BOSCH injection
pump 0445010223
(Renault Megane 2012)



DL-UNI31207

Universal flange with
mounting hole
diameter 50 mm, without
mounting holes.
Created for independent
fastening holes for pumps
which boarding diameter
50 mm.



DL-UNI31208

Universal flange
with mounting hole
diameter 60 mm, without
mounting holes.
Created for independent
fastening holes for pumps
which boarding diameter
60 mm

**DL-CR30866**

Flange for stand mounting
High pressure fuel pump CR DELPHI
with landing 50 mm in diameter and
three mounting holes:
two of which are located
perpendicular to the plane
mounting hole, and one
parallel to it.

**DL-CR31228 (CP383)**

Mounting flange for injection pump CR
BOSCH 0445010091 MB Sprinter,
Viti, Viano2, 1 l. Since 2006
Mounting hole 50mm.

**DL-CR31513**

Flange for stand mounting
High pressure fuel pump CR
CP3S3/K140/40-789S
Bosch 0445020125
Mounting hole 107 mm

**DL-CR50267**

Corner stand for fastenings for
injection pump CR SIEMENS
when tested on the stand.

**DL-CR50266**

Corner stand for CR DENSO
injection pump mountings
097300-0023 during testing
on the stand.

COUPLINGS

**DL-UNI50132**

Compensation clutch with clamping jaws and reinforced package plate

**DL-UNI50139**

Compensation clutch with flange connection and reinforced package plates (analogue Bosch 1686401024)

**DL-CB230016**

Conical coupling with flange connection
Ø 30 mm
Cam Box2, injection pump

**DL-CB130139**

Conical coupling
Ø 30 mm
Cam Box2, injection pump

**DL-M22 (UNI31481)**

Cone coupling Ø 22 mm
for injection pump CR

**DL-M23 (UNI30917)**

Cone coupling Ø 23 mm
for injection pump Continental A2C59517053, Bosch CR\ CP4HS2 0445010637, CP4S2 0445010611, CP4S1 0445010506

**DL-M24 (UNI30127)**

Cone coupling Ø 24 mm
for injection pump CRSR-3 mod.044502088

**DL-M24L (CR31098)**

Long sleeve Ø 24 mm
for injection pump DENSO HP0

**DL-MS8**

Coupling slotted for injection pump CR (for MV slot 8x18)

**DL-MS9**

Coupling slotted for CR injection pump (for Renault slot 9x20)

**DL-MS10D**

Coupling slotted for injection pump CR Denso, slot 10x23

**DL-MS10 S**

Муфта шлицевая для ТНВД Siemens Peugeot Boxer 2.2, шлиц 10x21,6

**DL-MS11**

Coupling slotted for injection pump CR MAN (11 splines)

**DL-M17**

Cone coupling Ø 17 mm
for injection pump CR and injection pump VE

**DL-M19**

Cone coupling Ø 19 mm
for CR and VE injection pumps

**DL-CR31703**

Coupling for clamping jaws for injection pump CR Delphi 28384347

**DL-MS4 (CR30955)**

Coupling for injection pump Bosch 0445010512
Grooves for splines are made on the coupling pump connector and cone for centering.

**DL-CR31416**

Coupling for injection pump Bosch 0445010512 CR / CP4S1
Grooves for splines are made on the coupling pump connector and cone for centering. Fastening is carried out to expansion joint flange. Fits to stands BOSCH EPS-815, CR-Test 4E, CR-Test 2P and mounts adapted to them.

**DL-UNI31025**

Coupling for injection pump Bosch CP1
(included insert UNI31028 with groove 8 mm wide) and for high pressure fuel pump VDO (included insert UNI31027 with 9mm slot). Can be used on Bosch stands instead couplings 1685702090. Suitable for BOSCH stands EPS-815, CR-Test 4E, CR-Test 2P and customized attachments to them.

**DL-UNI31029**

Coupling DL-UNI31029 for injection pump Denso
(included insert UNI31030 with groove 10 mm wide). Suitable for BOSCH stands EPS-815, CR-Test 4E, CR-Test 2P and fittings adapted to them.

**DL-CR31669**

Flange type coupling for injection pump CR Delphi 28384347
Fastening is carried out to the flange compensation clutch. Suitable for stands BOSCH EPS-815, CR-Test 4E, CR-Test 2P and fittings adapted to them.

**DL-CR31271**

Coupling cone 17mm for testing CR pumps and VE injection pumps

Fastening is carried out to the flange compensation clutch. Suitable for stands BOSCH EPS-815, CR-Test 4E, CR-Test 2P and fittings adapted to them.

**DL-CR31269****Coupling cone 19mm
for testing CR pumps and VE injection pumps**

Fastening is carried out to the flange compensation clutch. Suitable for stands BOSCH EPS-815, CR-Test 4E, CR-Test 2P and fittings adapted to them.

**DL-CR31558 (K23)****Cone coupling 23 mm for high pressure fuel pump CR Bosch and Continental**

Fastening is carried out to the flange compensation clutch. Suitable for CR-Test stands, BOSCH EPS-815 and mounts adapted to them

Installed injection pump CR:

- Continental A2C59517053
- BOSCH CR/CP4HS2 0445010637
- BOSCH CR/CP4S2 0445010611
- BOSCH CR/CP4S1 0445010506

**DL-CR31251****Cone coupling 24mm for high pressure fuel pump CR CP-3**

Fastening is carried out to the flange compensation clutch. Suitable for stands BOSCH EPS-815, CR-Test 4E, CR-Test 2P and fittings adapted to them.

**DL-CR31248****Coupling spline (11 splines) for injection pump CR MANN**

Fastening is carried out to the flange compensation clutch. Suitable for stands BOSCH EPS-815, CR-Test 4E, CR-Test 2P and adapted to them fasteners.

**DL-CR31480****Cone coupling 22 mm for checking pumps CR Siemens (VDO).**

Fastening is carried out to the flange compensation clutch. Suitable for stands BOSCH EPS-815, CR-Test 4E, CR-Test 2P and adapted to them fasteners.

**DL-CR31594****Coupling K35 for connection on the stand Fuel pump CP2 MAZ**

Fastening is carried out to the flange compensation clutch. Suitable for stands BOSCH EPS-815, CR-Test 4E, CR-Test 2P and adapted to them fasteners.

**DL-CR50137**

Set of equipment for the repair of injection pump CR CP4 Bosch.

Contents of delivery:

- **DL-CR30861** Flange - 1 pc.
- **DL-CR30862** Flange - 1 pc.
- **DL-UNI50083** Adapter - 1 pc.
- **DL-UNI50084** Adapter - 2 pcs.
- **DL-UNI30980** Nut M16x1 - 3 pcs.
- **DL-CR31003** Socket for pump valve CP4 - 1 pc.

**DL-CR50151**

Stand support kit pumps Denso HP0.

Contents of delivery:

- **DL-CR31094** Support - 2 pcs.
- **DL-UNI30090** Profile bolt - 2 pcs.
- Nut M14 - 2 pcs.
- Washer 14mm - 2 pcs.
- Grover 14mm - 2 pcs.

**DL-CR50315**

Device for hanging the pusher of plunger pairs, BOSCH CP2 pumps of the system Common Rail

**DL-CR50156**

Set of clamps for assembly of injection pump CP3 (Similar to SIRINI AZ0128-427)

Contents of delivery:

- Clamp **DL-CR50152** - 3 pcs.

**DL-CR50307**

Clamp for dismantling the dosing injection pump valve CR CP3

Contents of delivery:

- **DL-CR31580** clamp body - 1 pc
- **DL-CR31582** clamp slide - 1 pc.
- **DL-CR31581** clamp axle - 1 pc.
- Pins - 2 pcs.
- Recessed fixing bolt - 1 pc.

**DL-CR31003**

Socket for mounting / dismounting valve injection pump CR CP4 Bosch for torque wrench 1/2".

DL-CR50364

A set of fittings with a lock for checking the injection pump CP1

Contents of delivery:

- **DL-CR31683** Connector dia. 8mm - 2 pcs.
- **DL-CR31676** Mounting strip - 1 piece,
- **D-27-013700** O-ring - 2 pcs.

**DL-CR50198**

Adapter for measuring pressure in HPFP CR CP-3.

It is installed instead of the dispenser.

Contents of delivery:

- Adapter Body - 1/8" Barb - Herringbone for hose with internal Ø10mm

ATTENTION! *Quick connector not included in the scope of delivery and must be ordered separately.*

**DL-CR31497**

Pressure adapter booster pump CR

ATTENTION! *The adapter comes without tube fittings and pressure gauge!*

DL-CR31497KIT

Pressure adapter kit booster pump CR

Contents of delivery:

- **DL-SP09570** L-shaped "quick" adapter M5x4mm
- **DL-SP09580** Fitting "mother" 1/4"x4mm for manometer
- **DL-P1002** Flexible PVC tube dia.4mm (100cm)
- **D-12-TV63-016** Pressure gauge 16 bar with lower fitting 1/4"



ACCESSORIES FOR DL-CR31497 ADAPTER



D-12-TV63-010

Pressure gauge 0÷10bar, Ø63 with bottom fitting 1/4"

D-12-TV63-016

Pressure gauge 0÷16 bar, Ø63 with bottom fitting 1/4"



34-RL3104M5

Angle adapter
M5 x Ø4mm with collet



34-RL020402

adapter with internal thread G1/4" x Ø4mm with collet



34-RL0104M5

Adapter straight
M5 x Ø 4mm with collet

34-RL3106M5

Angle adapter
M5 x Ø6mm with collet

34-RL020602

adapter with internal G1/4"xØ6mm thread with collet

34-RL0106M5

Adapter straight
M5 x Ø 6mm with collet



34-RA30-4,5-M5

Fitting straight
M5 x Ø4mm herringbone



34-MC130614

adapter with internal thread G1/4"x Ø 6mm with union nut



34-MC2306M5C

Fitting kit
"banjo" M5 with a union tube nut
Ø 6mm x Ø4mm



DL-MSDE

Fitting kit
"banjo" M5 x Ø4mm



DL-P1002

PVC tube
Ø outer 4mm

DL-P1004

Teflon tube
Ø outer 6mm



DL-CR50246

Manometer mounting bracket.
Made in the form of a hook and gauge holder brackets. Used with pressure gauges of the series **D-12-TV63**



DL-R1001

fuel hose
Ø int. 4mm

**DL-UNI50264****Fitting 3/8 "x8 mm****Designed for the following equipment:**

1. Stands CR-Test, SPF, SPN, DORPAT
 2. FMDE device (2-channel liquid flow meter)
 3. "PUMP-TEST.02" Test equipment
- CR high pressure pumps

The fitting has a 3/8" thread and is designed for hose diameter 8 mm

**DL-UNI50265****Fitting 3/8 "x10 mm****Designed for the following equipment:**

1. Stands CR-Test, SPF, SPN, DORPAT
 2. FMDE device (2-channel liquid flow meter)
 3. "PUMP-TEST.02" Test equipment
- CR high pressure pumps

The fitting has a 3/8" thread and is designed for hose diameter 10 mm

**DL-UNI50126****5 µm liquid filter with 3/8" outlets****DL-UNI50047****5 µm liquid filter with fittings (herringbone) by 10 mm**

DORPAT Multi-Cam11

The test stand is designed to test pump injectors, pump sections.

DORPAT Multi-Cam11 – The stand can be used for fuel equipment of any diesel engines of light and medium traction, including high-speed engines of cars, buses, trucks and agricultural tractors with UIS (unit injector system) and UPS (unit pump system) fuel equipment installed on them.

Stands are produced with a capacity of 11 kW.

The measurement takes place in an electronic system.



DORPAT Multi-Cam11**STAND EQUIPMENT**

2CB20001	CamBox CB	1 pc
DL-CB230016	Drive Coupling CamBox2	1 pc
DL-CB230010	Spray nozzle bracket	1 pc
	Bolt M10,L=106mm, bolt M10,L=56mm for brackets. atomizer nozzles	1 set
DL-CB230012	Spray nozzle Ø 9mm	1 pc
DL-CB230022	Injector clip	1 pc
DL-CB230046, DL-CB230047, DL-CB230048, DL-CB230049	Sealing washers atomizer	1 set
DL-CB230013	Cam stroke position lock	2 pcs
DL-CB230084	Remote bushing H=7 Ø20 for mounting the clip under the passenger NF	2 pcs
DL-CB230109	Pusher screw for pump injector spherical	1 pc
DL-CB230134	Screw pusher for pump-injector spherical short	1 pc
DL-CB230135	Screw-pusher for pump-injector internal	1 pc
DL-CB230043	Pusher screw with nut for pumping sections M12x1.25	1 pc
DL-CB20151	Clamp-adapter No. 0151 for Audi / VW1.9 unit injectors	1 pc
DL-CB20152	Clamp-adapter No. 0152 for Audi / VW2.0 unit injectors	1 pc
DL-CB20124	Clamp-adapter No. 0124 for pump-injectors Volvo FH12, Iveco, Bosch	1 pc
DL-CB20148	Clamp-adapter No. 0148 for unit injectors Volvo FH12, Delphi E3	1 pc
DL-CB20140	Clamp-adapter No. 0140 for Scania unit injectors	1 pc
DL-CB20129	Clamp-adapter No. 0129 for MBActros unit injectors	1 pc
DL-CB201333	Clamp-adapter No. 0133 for MBAtego unit injectors	1 pc
DL-CB20144	Clamp-adapter No. 0144 for pump injectors DAF, MAK, Renault	1 pc
DL-CB20123	Clamp-adapter No. 0123 for PLD sections of unit injectors No. 0129,133,144	1 pc
DL-CB20100	Clamp-adapter No. 0100 for installing the indicator head	1 pc
DL-UNI30035	Fitting for clamp-adapter M14x1.5x1/4"	16pcs
1/4MBSPF04	Quick coupler male hydraulic 1/4"	2 pcs
D-GM1538AN	Rubber-metal gasket ØM14	20pcs
D-GM1504AN	Gasket rubber-metal Ø1/4"	20pcs
DL-UIS0920B	Adapter cable for Bosch injector universal	1 pc
DL-UIS0921D1	Adapter cable for Delphi E3 injector 4-pin	1 pc

DORPAT Multi-Cam11

STAND EQUIPMENT

DL-UIS0922D2	Adapter cable for injectors Delphi E3 4-pin second type	1 шт.
DL-UIS0923D	Adapter cable for Delphi injector 2-pin	1 шт.
DL-UIS0924V	Adapter cable for VW injector	1 шт.
DL-CB250001	Adjustable gauge for setting the preload of the unit injector	1 шт.
	Supply hose 3/8"x1/4"x750mm 34-K2-212D - Ø1/4" female quick coupler (1pc)	1 к-т.
	Backflow outlet hose 3/8"x1/4"x700mm 34-K2-212D - Ø1/4" female quick coupler (1pc)	1 к-т.
	Bolt Banjo 1/4" (2pcs) + Bolt Banjo M14x1.5 (2pcs)	1 к-т.
	The quick adapter from the spray nozzle to the tube will measure. 1/8" x 1/8" vUNI30081	1 шт.
DL-UNI50138	Measuring tube Teflon flexible in steel braid for flow measurement	1 шт.
P1004	Teflon tube Ø 6mm x 1500mm	1 шт.
34-RL020602	Fitting (quick adapter) Ø 6mm x 1/4"	1 шт.
D1530075	Handwheel for scrolling the flywheel	1 шт.
	Cushioning legs (4 pcs.) + Door key (4 pcs.)	1 к-т.
	Program with test plans from the manufacturer (1 pc.)	1 шт.
	Compensation spring (red L=76mm) for plunger travel 10-12mm	1 шт.
DL-CB230169	Pusher for compensating spring (red L=76mm)	1 шт.
DL-UNI31222	Open-end wrench 22mm	1 шт.

DORPAT Multi-Cam11

STAND EQUIPMENT

**DL-UIS0920B**

Cable for BOSCH injectors (universal)

**DL-UIS0921D1**

Cable for injectors Delphi E3 4-pin

**DL-UIS0923D**

Cable for Delphi injectors 2-pin

**DL-UIS0924V**

Cable for VW injectors

**DL-UIS0922D2**Cable for injectors Delphi E3 4-pin
second type

DORPAT Multi-Cam11

STAND EQUIPMENT

**DL-CB20124**

Clamp for injectors Volvo FH12, Iveco, Bosch
0414701004, 0414701006, 0414701013, 0414701014,
0414701015, 0414701021, 0414701022, 0414702002,
0414702003, 0414702005, 0414702006, 0414702007,
0414702009, 0414702010, 0414702012,
0414702013, 0414702014, 0414702015

to Cam Box 2 of the DORPAT stand
Delivery set: clamp - 1 pc, fitting - 2 pcs,
rubber-metal. gasket - 4 pcs.

**DL-CB20148**

Clamp for injectors Volvo FH12, Delphi E3
to Cam Box 2 of the DORPAT stand

Delivery set: clamp - 1 pc, fitting - 2 pcs,
rubber-metal. gasket - 4 pcs.

**DL-CB2 0151**

Clamp for injectors Audi / VW 1.9
0414720002, 0414720003, 0414720005, 0414720007, 0414720008,
0414720009, 0414720013, 0414720014, 0414720015, 0414720016,
0414720018, 0414720028, 0414720029, 0414720030, 0414720033,
0414720034, 0414720035, 0414720036, 0414720037, 0414720038,
0414720039, 0414720201, 0414720204, 0414720206, 0414720208,
0414720209, 0414720210, 0414720213, 0414720214, 0414720215,
0414720216, 0414720217, 0414720220, 0414720221, 0414720222,
0414720223, 0414720224, 0414720225, 0414720226, 0414720227,
0414720228, 0414720229, 0414720230, 0414720231, 0414720232,
0414720301, 0414720302, 0414720303, 0414720304, 0414720305,
0414720306, 0414720307, 0414720308, 0414720309, 0414720310,
0414720311, 0414720312, 0414720313, 0414720314

to Cam Box 2 of the DORPAT stand
Delivery set: clamp - 1 pc, fitting - 2 pcs,
rubber-metal. gasket - 4 pcs, tack - 1 pc,
fixing screw - 1 pc.

**DL-CB20152**

Clamp for injectors Audi / VW 2.0
0414720401, 0414720402, 0414720403, 0414720404

to Cam Box 2 of the DORPAT stand

Delivery set: clamp - 1 pc, fitting - 2 pcs,
sealing washer - 4 pcs, fixing screw - 2 pcs.

DORPAT Multi-Cam11

STAND EQUIPMENT

**DL-CB20140****Clamp for Scania injectors**

0414701017, 0414701018, 0414701019, 0414701020,
0414701030, 0414701032, 0414701035, 0414701036,
0414701037, 0414701038, 0414701040, 0414701042,
0414701043, 0414701044, 0414701045, 0414701069,
0414700002, 0414701005, 0414701007, 0414701008,
0414701016

to Cam Box 2 of the DORPAT stand

Delivery set: clamp - 1 pc, fitting - 2 pcs,
rubber-metal. gasket - 4 pcs.

**DL-CB20129****Clamp for PLD Mercedes Actros**

0414799005, 0414799007, 0414799009, 0414799010,
0414799011, 0414799015, 0414799016, 0414799018,
0414799021, 0414799023, 0986445002

to Cam Box 2 of the DORPAT stand

Delivery set: clamp - 1 pc, fitting - 2 pcs,
rubber-metal. gasket - 4 pcs.

**DL-CB20133****Clamp for PLD Mercedes Atego**

0414799003, 0414799006, 0414799008, 0414799012,
0414799013, 0414799014, 0414799017, 0414799019,
0414799022, 0986445003

to Cam Box 2 of the DORPAT stand

Delivery set: clamp - 1 pc, fitting - 2 pcs,
rubber-metal. gasket - 4 pcs.

**DL-CB20144****Clamp for PLD DAF, MAK, Renault**

0414755005, 0414755006, 0414755007, 0414755008,
0414755014, 0414755015, 0414755016, 0414755017,
0414755018

to Cam Box 2 of the DORPAT stand

Delivery set: clamp - 1 pc, fitting - 2 pcs,
rubber-metal. gasket - 4 pcs.

DORPAT Multi-Cam11**STAND EQUIPMENT****DL-CB20100**

**Clamp-adaptor for indicator head
to Cam Box 2 of the DORPAT stand**

Delivery set: clamp – 1 pc.

**DL-CB20123D**

**Clamp-adaptor for PLD sections
pump injectors 0129, 0133, 0144, 0145
to Cam Box 2 stand DORPAT**

Delivery set: clamp – 1 pc.

**DL-UNI31222**

**Open-end wrench
at 22mm**

DORPAT Multi-Cam11

OPTIONAL EQUIPMENT

**DL-CB20125KIT**

**Inspection and test kit
unit injector Caterpillar C12
to CamBox 2 of the DORPAT stand.**

Contents of delivery:

- clip-adapter **DL-CB20125** – 1 pc.
- injector pusher **CB230276** (for C13)
- sealing washer **SV230289**
- nozzle for sprayer **SV230282**
- fitting to the adapter - 2 pcs.
- rubber-metal gasket - 4 pcs.

Nozzle not included.

**DL-CB20126KIT**

**Inspection and test kit
injectors Caterpillar C15, C13 (CAT2490713) Perkins
to CamBox 2 of the DORPAT stand.**

Contents of delivery:

- clip-adapter **DL-CB20126** – 1 pc.
- injector pusher **CB230294** (for C15)
- injector pusher **CB230276** (for C13)
- sealing washer **SV230289**
- nozzle for sprayer **SV230282**
- fixing bracket **SV230283**
- fitting to the adapter - 2 pcs.
- rubber-metal gasket - 4 pcs.

Nozzle not included.

**DL-CB20127**

Clamp for PLD Detroit (Bosch)
0414750003, 0414750004
to Cam Box 2

Delivery set: clamp - 1 pc, fitting - 1 pc,
rubber-metal. gasket - 2 pcs.

**DL-CB20128**

Clamp for injectors Iveco 7,8 Liters

0414700002, 0414700003, 0414700004, 0414700005,
0414700006

to Cam Box 2

Delivery set: clamp - 1 pc, fitting - 2 pcs,
rubber-metal. gasket - 4 pcs.

DORPAT Multi-Cam11

OPTIONAL EQUIPMENT

**DL-CB20130**

Clamp for injectors
0414703005, 0414703007
to Cam Box 2

Delivery set: clamp - 1 pc, fitting - 2 pcs,
rubber-metal. gasket - 4 pcs.

**DL-CB20131**

Clamp for UD Nissan injectors
0414701023, 0414701024, 0414701033, 0414701034
to Cam Box 2

Delivery set: clamp - 1 pc, fitting - 2 pcs,
rubber-metal. gasket - 4 pcs.

**DL-CB20136**

Clamp for Land Rover-Discovery injectors
(Delphi)
to Cam Box 2

Delivery set: clamp - 1 pc, fitting - 2 pcs,
rubber-metal. gasket - 4 pcs.

**DL-CB20137KIT**

Clamp for Caterpillar L10 injectors
to Cam Box 2

Kit includes:

- Clamp adapter **DL-CB20137**
- Sealing washer **SV230289**
- Nozzle for sprayer **SV230282**
- Fitting to the adapter - 2 pcs.
- Rubber-metal gasket - 4 pcs.

Nozzle not included.

DORPAT Multi-Cam11

OPTIONAL EQUIPMENT

**DL-CB20138KIT**

**Inspection and test kit
pump injector Detroit 5234770-5235580
to CamBox 2 of the DORPAT stand.**

Contents of delivery:

- clip-adapter **DL-CB20138** – 1 pc.
- nozzle pusher **SV230276** – 1 pc.
- fixing bracket **SV230440** – 1 pc.
- fitting to the adapter - 2 pcs.
- rubber-metal gasket - 4 pcs.

Nozzle not included.

**DL-CB20139KIT**

**Inspection and test kit
pump injector Cummins 4DEC01L4061851
to CamBox 2 of the DORPAT stand.**

Contents of delivery:

- clip-adapter **DL-CB20139** – 1 pc.
- fixing bracket **SV230440** – 1 pc.
- fitting to the adapter - 2 pcs.
- rubber-metal gasket - 4 pcs.

Nozzle not included.

**DL-CB20145**

**Clamp for PLD DELPHI
to Cam Box 2 of the DORPAT stand**

Delivery set: clamp - 1 pc, fitting - 2 pcs,
rubber-metal. gasket - 4 pcs.

**DL-CB20146**

**Clamp for injectors
Caterpillar L15
to Cam Box 2 of the DORPAT stand**

Delivery set: clamp - 1 pc, fitting - 2 pcs,
rubber-metal. gasket - 4 pcs.

DORPAT Multi-Cam11

OPTIONAL EQUIPMENT

**DL-CB20146KIT**

Clamp for Caterpillar L15 injectors to Cam Box 2

Kit includes:

- Clamp adapter **DL-CB20146**
- Sealing washer **SV230289**
- Nozzle for sprayer **SV230282**
- Injector pusher **CB230294**
- Fixing bracket **SV230283**
- Fitting to the adapter - 2 pcs.
- Rubber-metal gasket - 4 pcs.

Nozzle not included.

**DL-CB20149**

Clamp for Bosch injectors

0414703004, 0414703008, 0414703009, 0414703013

to Cam Box 2 of the DORPAT stand

Delivery set: clamp - 1 pc, fitting - 2 pcs, rubber-metal. gasket - 4 pcs.

**DL-CB20153KIT**

Inspection and test kit

pump injector Bosch 0414703003

to CamBox 2 of the DORPAT stand.

Contents of delivery:

- clip-adapter **DL-CB20153** – 1 pc;
- nozzle pusher **SV230276** – 1 pc;
- fitting to the adapter - 2 pieces;
- rubber-metal gasket - 4 pcs.

Nozzle not included.

**DL-CB20154KIT**

Kit for checking and testing unit injectors

CumminsHPI to DORPAT CamBox 2.

Contents of delivery:

- clip-adapter **DL-CB20154** – 1 pc.
- nozzle pusher **CB230356** – 1 pc.
- nozzle for sprayer **CB230357** – 1 pc.
- valve holder **CB230355** – 1 pc.
- bracket **CB220007** for valve holder – 1 pc.
- Timing valve - 1 pc.
- Metering valve – 1 pc.
- steel braided hose – 2 pcs.
- fitting for a hose - 4 pcs.
- fitting to the adapter - 2 pieces;
- rubber-metal gasket - 4 pcs.
- pressure nozzle - 1 pc.

DORPAT Multi-Cam11

OPTIONAL EQUIPMENT

**DL-CB20155**

Clamp for injectors Delphi E1 (John Deere) to Cam Box 2 of the DORPAT stand

Delivery set: clamp - 1 pc, fitting - 2 pcs, rubber-metal. gasket - 4 pcs.

Nozzle not included.

**DL-CB20156**

Clamp adapter for testing unit injectors CAT 3920206

Delivery set: clip - 1 pc, fixing bracket - 1 pc, fixing bolt of the clamp-lock 8x35 - 2 pcs, fitting - 2 pcs, rubber-metal. gasket - 4 pcs

Nozzle not included.

**DL-CB20157**

Test adapter clamp pump injector Cummins 3053124

Delivery set: clamp - 1 pc, fitting - 2 pcs, rubber-metal. gasket - 4 pcs.

Nozzle not included.

**DL-CB20158**

Adapter clip for injectors CUMMINS 4902827

Scope of delivery:

DL-CB231672 adapter clip № 0158 — 1 pc;

DL-CB231675 bracket-retainer — 1 pc;

DL-CB230357 nozzle on the sprayer — 1 pc;

DL-UNI30035 fitting for the adapter clip M14x1,5x1/4" — 3 pcs;

D-GM1538AN rubber-metal gasket ØM14 — 3 pcs;

D-GM1504AN rubber-metal gasket Ø1/4" — 3 pcs.

Nozzle not included.

DORPAT Multi-Cam11

OPTIONAL EQUIPMENT

**DL-CB2 50037**Injection sensor for unit injectors
Cummins HPI**DL-CB250036KIT**injection sensor
(piezo)**25-FPKM-04**Fitting - quick adapter
for adapter**25-FPKF-04**Hydraulic Quick Connector
female connections 1/4"

DORPAT Multi-Cam11**OPTIONAL EQUIPMENT****1680750120**

Tube for test nozzle
to the DORPAT Multi-Cam stand

**1688901119**

Test nozzle for checking
fuel equipment to the stand
DORPAT Multi-Cam

1688901118

Test nozzle for checking
fuel equipment to the stand
DORPAT Multi-Cam

**ISO-100-V5**

Jet 0.5mm

**DL-UNI30229**

Tip (with gaskets and fitting)
for test injector to DORPAT stand
Multicam

Contents of delivery:
tip - 1 pc, rubber-metal gasket - 2 pcs,
connecting fitting 1 pc

CAM-BOX1 FORCE

Basic kit for testing unit injectors and single pumps (UI / UP SYSTEM).

Kit includes:

1. CAMBOX 1
2. Controller UIS TESTER V6

**CAMBOX 1**

Mechanical part to check injector pump.

The basic version comes with clip for Volvo FH12 unit injectors and some Iveco injectors Bosch. Clips for other nozzles by additional order.

**UIS TESTER V6**

Controller - electronic part to check pump injectors.

Device for testing and performance checks unit injectors (UIS) and individual fuel pumps (pump sections) high pressure with solenoid valves high pressure (UPS).

CAM-BOX1

EQUIPMENT

**Crankcase - protective cover**

- Included in CAM-BOX1:
- crankcase 3pcs.

**Injector nozzle**

- Included in CAM-BOX1:
- nozzle - 3 pieces,
 - fitting - 3 pcs.

**Threaded pusher**

- Included in CAM-BOX1:
- spherical pusher - 1 piece,
 - concave pusher - 1 pc.

**Pen holder**

- Included in CAM-BOX1:
- handle - 1 pc.

**Mounting guides
Cam box on stand**

- Included in CAM-BOX1:
- guide sleeve - 2 pcs.

CAM-BOX1

EQUIPMENT

**Clamp for injectors Volvo FH12 and
some Bosch Iveco injectors
CB0124-01**

Included in CAM-BOX1:

- clamp - 1 pc.

**Hose kit to adapter -
clamp**

Included in CAM-BOX1:

- pressure valve - 1 piece,
- banjo bolt - 1 piece,
- banjo fitting - 2 pcs.,
- washers - 4 pcs.

Clamp for injectors

Included in CAM-BOX1:

- clamp - 1 pc.

Atomizer Kit

Included in CAM-BOX1:

- atomizer holder - 1 pc,
- adapter for atomizer 7mm - 1pc,
- fitting - 1 pc.

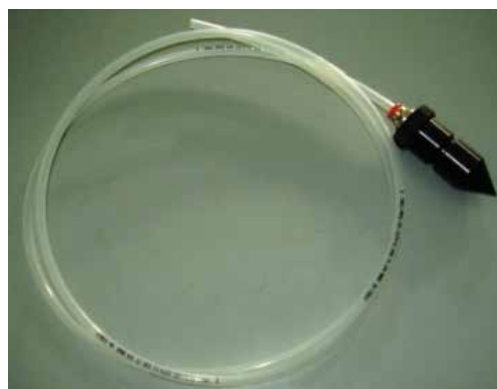
Strait Kit

Included in CAM-BOX1:

- defoamer - 1 piece,
- fitting - 1 piece,
- PVC tube 6mm x 1.5m – 1 pc.

CAM-BOX1



KV

Camshaft
for LandRov, Iveco Cur, VW
Contents of delivery:
• Cam shaft - 1 pc.



VW

Adapter for Audi / VW
Contents of delivery:
• adapter 2 pcs (2 options),
• spray tip,
• fitting - 1 piece,
• side fitting - 1 pc,
• clamp - 1 piece,
• fastening bolt - 1 pc.



CB 0136-01 LR

Clamp for injectors
Land Rover Discovery
Contents of delivery:
• clip - 1pc,
• fitting - 1 piece,
• clamp - 1 piece,
• tip on
the spray nozzle
ø=7mm - 1pc.



CB0140-01 SC

Clamp for injectors
Scania
Contents of delivery:
• clip - 1pc,
• pusher - 1 pc.



CB0148-01500 HP

Clamp for injectors
Volvo 500HP Delphi
Contents of delivery:
• clamp - 1 pc.



CB0147-01 JD

Clamp for injectors
John Deere Delphi
Contents of delivery:
• clamp - 1 pc.

OPTIONAL EQUIPMENT



MU

Mounting sleeve
to the pump flange for
TNVDP, PE and for CAM BOX
Contents of delivery:
• coupling - 1 piece,
• lock washer - 1 piece,
• fixing nut- 1 PC.



CB 0128-01 IVECO

Clamp for Iveco 7,8L
Contents of delivery:
• clamp - 1 piece,
• side fitting - 1 pc.



CB 0129-01 ACT

Clamp for injectors
Mercedes Actros
Contents of delivery:
• clamp - 1 piece,
• adapter AZ0309-01 - 1 pc,
• side fitting DL-EA - 1pc



CB0133-01 AT

Clamp for injectors
Mercedes Atego
Contents of delivery:
• clip - 1pc,
• adapter AZ0309-01 - 1 pc,
• side fitting DL-EA - 1pc



CB0144-01 DAF

Clamp for injectors
Clamp for injectors
DAF, MAK, Renault
Contents of delivery:
• clip - 1pc,
• adapter AZ0309-02 - 1 pc,
• side fitting - 1 pc,
• cola receiver - 1 piece,
• fitting - 2 pcs.

CAM-BOX1

OPTIONAL EQUIPMENT

**CB0146-01 CAT15**

**Clamp for injectors
Caterpillar L15**

Contents of delivery:

- clamp-1pc, • clamp-1pc,
- spray tip
- nozzles Ø- "cone" - 1 pc,
- crankcase – 1 pc, fitting – 1 pc.

**CB0137-01 CAT10**

**Clamp for injectors
Caterpillar L10**

Contents of delivery:

- clip - 1pc,
- spray tip
- nozzles Ø=10.5mm – 1pc,
- fitting - 1 piece

**CB0138-01 DET**

**Clamp for injectors
Detroit**

Contents of delivery:

- clip - 1pc,
- spray tip
- nozzles Ø=8.5mm – 1pc,
- clamp - 1 piece,
- fitting - 1 piece

**CB0139-01 CUM**

**Clamp for injectors
Cummins**

Contents of delivery:

- clip - 1pc,
- spray tip
- nozzles Ø=8.5mm – 1pc,
- clamp - 1 piece,
- fitting - 1 piece

**DL-CB230017**

**Flange for sensor
revolutions
to CAM BOX1 and to
CAM BOX2**

- flange – 1pc

**DL-UNI50038**

**Encoder housing
for 5000 impulses
for CAM BOX1 and CAM BOX2**

- encoder housing – 1pc

**PCIDS2ZNKW-M8-45-M8**

**Rev. sensor
for CAM BOX 1**

Contents of delivery:

- sensor - 1 piece,
- connecting
cable - 1pc,
- fastening nut – 2 pcs.

**DL-CBTS**

**Pusher spherical
to rocker on CAM BOX1**

**DL-CBT**

**Pusher concave to
rocker on CAM BOX1**

**0232103064**

**RPM sensor
for CAMBOX 1 and
CAMBOX 2**

CAM-BOX 2 MASTER

Kit for testing unit injectors and single pumps (UI / UP SYSTEM).

Kit includes:

1. CAM-BOX 2 MECHANIC
2. Controller UIS TESTER Multi-CAM

**CAM-BOX 2 MECHANIC****Mechanical part to check
pump nozzles and pump sections.**

Device for testing and performance checks unit injectors (UIS) and individual fuel pumps (pump sections) high pressure with electromagnetic high pressure valves (UPS). The CAM-BOX2 MECHANIK has integrated inductive speed sensor and sensor angle (encoder) allowing to read indication of revolutions and angles for testing of modern EUI systems and EUP

**UIS TESTER Multi-CAM****Electronic part for checking
pump injectors**

Test and Verification Instrument unit injector performance (UIS) and individual fuel pumps (pump sections) high pressure with high pressure solenoid valves pressure (UPS).

CAM-BOX 2 MECHANIC

EQUIPMENT



DL-CB2 0124

Clamp for injectors Volvo FH12, Iveco, Bosch
0414700002, 0414701004, 0414701006, 0414701013, 0414701014,
0414701015, 0414701021, 0414701022, 0414702002, 0414702003,
0414702005, 0414702006, 0414702007, 0414702009, 0414702010,
0414702012, 0414702013, 0414702014, 0414702015



DL-CB230035

Fitting Ø M14 (1.5) x1/4 " - 2 pcs.
with rubber-metal
gasket - 4 pcs.



DL-CB2 0123

Clamp-adaptor
for sections PLD NF
0129.0133.0144



DL-CB230022

Bracket-clamp



DL-CB250061

**test holder nozzles to
the clamp adaptor**



DL-CB230010

**Bracket-nozzles and
spray nozzle**
Ø 7mm

DL-CB230012

Spray nozzle Ø 9mm



M10 bolt, L= 106mm, M10 bolt, L= 56mm
for nozzle bracket



DL-CB2 0100

**Clip-adaptor for
indicator head**



**DL-CB230046, CB230047,
CB230048, CB230049**

Sealing washer (4pcs)



DL-CB230084

Remote bushing H=7 Ø 20
for installation of passenger NF (2 pcs.)



DL-CB230189

Remote bushing H=5 Ø 12
for installation of passenger NF (2 pcs.)



DL-CB230013

Retaining pin
(3 pcs)

CAM-BOX 2 MECHANIC

EQUIPMENT



DL-CB230109,CB230134,
DL-CB230135,DL-CB230043

Screw pusher (4pcs)



DL-CB250001

Caliber adjustable for
preload settings
injector pump



Banjo fitting, Banjo bolt,
rubber-metal gaskets
and hose clamps (2 sets)



pressure hose to
pump nozzle Ø 10x1000mm



return hose from
pump nozzle Ø 10x1000mm



DL-1004

Teflon tube
Ø 6mm x 1500mm



DL-UNI30001

Union with fitting
Ø 6mm x 1/8" for
teflon tube



DL-PG

Defoamer with
fitting Ø 6mm x 1/4"



D-5358

Compensating spring
for light injectors
(red)



DL-UNI30090

profile bolt
M14 x 44mm with nut and
washers for fastening
Cam-Box (2 sets)



DL-CB230169

pusher for
compensatory
springs



Back pressure valve
drain 2.5 bar

CAM-BOX 2 MECHANIC

OPTIONAL EQUIPMENT

**DL-UNI50132**

Compensation clutch
with clamping jaws and
reinforced package
plates

**DL-UNI50139**

Compensation clutch
with flange connection
and reinforced package
plates (analogue
Bosch 1686401024)

**DL-CB230016**

Conical coupling with
flange connection
Ø 30 mm
Cam Box2, injection pump

**DL-CB130139**

Cone coupling Ø 30 mm
Cam Box2, injection pump

**DL-CB230879**

Mounting key for CAM-BOX couplings
DL-CB130139 and DL-CB230016

CAM-BOX 2 MECHANIC

OPTIONAL EQUIPMENT

**DL-CB20124**

Clamp for injectors Volvo FH12, Iveco, Bosch
0414701004, 0414701006, 0414701013, 0414701014,
0414701015, 0414701021, 0414701022, 0414702002,
0414702003, 0414702005, 0414702006, 0414702007,
0414702009, 0414702010, 0414702012,
0414702013, 0414702014, 0414702015

to Cam Box 2 of the DORPAT stand

Delivery set: clamp - 1 pc, fitting - 2 pcs,
rubber-metal. gasket - 4 pcs.

**DL-CB20125KIT**

**Inspection and test kit
unit injector Caterpillar C12
to CamBox 2 of the DORPAT stand.**

Contents of delivery:

- clip-adaptor **DL-CB20125** – 1 pc.
- injector pusher **CB230276** (for C13)
- sealing washer **SV230289**
- nozzle for sprayer **SV230282**
- fitting to the adapter - 2 pcs.
- rubber-metal gasket - 4 pcs.

Nozzle not included.

**DL-CB20126KIT**

**Inspection and test kit
injectors Caterpillar C15, C13 (CAT2490713) Perkins
to CamBox 2 of the DORPAT stand.**

Contents of delivery:

- clip-adaptor **DL-CB20126** – 1 pc.
- injector pusher **CB230294** (for C15)
- injector pusher **CB230276** (for C13)
- sealing washer **SV230289**
- nozzle for sprayer **SV230282**
- fixing bracket **SV230283**
- fitting to the adapter - 2 pcs.
- rubber-metal gasket - 4 pcs.

Nozzle not included.

**DL-CB20127**

Clamp for PLD Detroit (Bosch)
0414750003, 0414750004
to Cam Box 2

Delivery set: clamp - 1 pc, fitting - 1 pc,
rubber-metal. gasket - 2 pcs.

CAM-BOX 2 MECHANIC

OPTIONAL EQUIPMENT

**DL-CB20128****Clamp for injectors Iveco 7,8 Liters**0414700002, 0414700003, 0414700004, 0414700005,
0414700006**to Cam Box 2****Delivery set:** clamp - 1 pc, fitting - 2 pcs,
rubber-metal. gasket - 4 pcs.**DL-CB20129****Clamp for PLD Mercedes Actros**0414799005, 0414799007, 0414799009, 0414799010,
0414799011, 0414799015, 0414799016, 0414799018,
0414799021, 0414799023, 0986445002**to Cam Box 2 of the DORPAT stand****Delivery set:** clamp - 1 pc, fitting - 2 pcs,
rubber-metal. gasket - 4 pcs.**DL-CB20130****Clamp for injectors**

0414703005, 0414703007

to Cam Box 2**Delivery set:** clamp - 1 pc, fitting - 2 pcs,
rubber-metal. gasket - 4 pcs.**DL-CB20131****Clamp for UD Nissan injectors**

0414701023, 0414701024, 0414701033, 0414701034

to Cam Box 2**Delivery set:** clamp - 1 pc, fitting - 2 pcs,
rubber-metal. gasket - 4 pcs.**DL-CB20133****Clamp for PLD Mercedes Atego**0414799003, 0414799006, 0414799008, 0414799012,
0414799013, 0414799014, 0414799017, 0414799019,
0414799022, 0986445003**to Cam Box 2 of the DORPAT stand****Delivery set:** clamp - 1 pc, fitting - 2 pcs,
rubber-metal. gasket - 4 pcs.

CAM-BOX 2 MECHANIC

OPTIONAL EQUIPMENT

**DL-CB20136**

Clamp for Land Rover-Discovery injectors (Delphi) to Cam Box 2

Delivery set: clamp - 1 pc, fitting - 2 pcs, rubber-metal gasket - 4 pcs.

**DL-CB20137KIT**

Clamp for Caterpillar L10 injectors to Cam Box 2

Kit includes:

- Clamp adapter **DL-CB20137**
- Sealing washer **SV230289**
- Nozzle for sprayer **SV230282**
- Fitting to the adapter - 2 pcs.
- Rubber-metal gasket - 4 pcs.

Nozzle not included.

**DL-CB20138KIT**

Inspection and test kit pump injector Detroit 5234770-5235580 to CamBox 2 of the DORPAT stand.

Contents of delivery:

- clip-adapter **DL-CB20138** – 1 pc.
- nozzle pusher **SV230276** – 1 pc.
- fixing bracket **SV230440** – 1 pc.
- fitting to the adapter - 2 pcs.
- rubber-metal gasket - 4 pcs.

Nozzle not included.

**DL-CB20139KIT**

Inspection and test kit pump injector Cummins 4DEC01L4061851 to CamBox 2 of the DORPAT stand.

Contents of delivery:

- clip-adapter **DL-CB20139** – 1 pc.
- fixing bracket **SV230440** – 1 pc.
- fitting to the adapter - 2 pcs.
- rubber-metal gasket - 4 pcs.

Nozzle not included.

CAM-BOX 2 MECHANIC

OPTIONAL EQUIPMENT

**DL-CB20140****Clamp for Scania injectors**

0414701017, 0414701018, 0414701019, 0414701020, 0414701030, 0414701032, 0414701035, 0414701036, 0414701037, 0414701038, 0414701040, 0414701042, 0414701043, 0414701044, 0414701045, 0414701069, 0414700002, 0414701005, 0414701007, 0414701008, 0414701016

to Cam Box 2 of the DORPAT stand

Delivery set: clamp - 1 pc, fitting - 2 pcs, rubber-metal. gasket - 4 pcs.

**DL-CB20144****Clip for PLDDAF, MAK, Renault**

0414755005, 0414755006, 0414755007, 0414755008, 0414755014, 0414755015, 0414755016, 0414755017, 0414755018

to Cam Box 2 of the DORPAT stand

Delivery set: clamp - 1 pc, fitting - 2 pcs, rubber-metal. gasket - 4 pcs.

**DL-CB20145****Clamp for PLD DELPHI****to Cam Box 2 of the DORPAT stand**

Delivery set: clamp - 1 pc, fitting - 2 pcs, rubber-metal. gasket - 4 pcs.

**DL-CB20146****Clamp for injectors****Caterpillar L15****to Cam Box 2 of the DORPAT stand**

Delivery set: clamp - 1 pc, fitting - 2 pcs, rubber-metal. gasket - 4 pcs.

**DL-CB20146KIT****Clamp for Caterpillar L15 injectors****to Cam Box 2****Kit includes:**

- Clamp adapter **DL-CB20146**
- Sealing washer **SV230289**
- Nozzle for sprayer **SV230282**
- Injector pusher **CB230294**
- Fixing bracket **SV230283**
- Fitting to the adapter - 2 pcs.
- Rubber-metal gasket - 4 pcs.

Nozzle not included.

CAM-BOX 2 MECHANIC

OPTIONAL EQUIPMENT

**DL-CB20149****Clamp for Bosch injectors**

0414703004, 0414703008, 0414703009, 0414703013

to Cam Box 2 of the DORPAT stand**Delivery set:** clamp - 1 pc, fitting - 2 pcs,
rubber-metal. gasket - 4 pcs.**DL-CB2 0151****Зажим для форсунок Audi / VW 1.9**0414720002, 0414720003, 0414720005, 0414720007, 0414720008,
0414720009, 0414720013, 0414720014, 0414720015, 0414720016,
0414720018, 0414720028, 0414720029, 0414720030, 0414720033,
0414720034, 0414720035, 0414720036, 0414720037, 0414720038,
0414720039, 0414720201, 0414720204, 0414720206, 0414720208,
0414720209, 0414720210, 0414720213, 0414720214, 0414720215,
0414720216, 0414720217, 0414720220, 0414720221, 0414720222,
0414720223, 0414720224, 0414720225, 0414720226, 0414720227,
0414720228, 0414720229, 0414720230, 0414720231, 0414720232,
0414720301, 0414720302, 0414720303, 0414720304, 0414720305,
0414720306, 0414720307, 0414720308, 0414720309, 0414720310,
0414720311, 0414720312, 0414720313, 0414720314**to Cam Box 2 of the DORPAT stand****Delivery set:** clamp - 1 pc, fitting - 2 pcs,
rubber-metal. gasket - 4 pcs, tack - 1 pc,
fixing screw - 1 pc.**DL-CB20152****Clamp for injectors Audi / VW 2.0**

0414720401, 0414720402, 0414720403, 0414720404

to Cam Box 2 of the DORPAT stand**Delivery set:** clamp - 1 pc, fitting - 2 pcs,
sealing washer - 4 pcs, fixing screw - 2 pcs.**DL-CB20153KIT****Inspection and test kit****pump injector Bosch 0414703003****to CamBox 2 of the DORPAT stand.****Contents of delivery:**

- clip-adapter **DL-CB20153** – 1 pc;
- nozzle pusher **SV230276** – 1 pc;
- fitting to the adapter - 2 pieces;
- rubber-metal gasket - 4 pcs.

Nozzle not included.

CAM-BOX 2 MECHANIC

OPTIONAL EQUIPMENT

**DL-CB20154KIT**

**Kit for checking and testing unit injectors
CumminsHPI to DORPAT CamBox 2.**

Contents of delivery:

- clip-adapter **DL-CB20154** – 1 pc.
- nozzle pusher **CB230356** – 1 pc.
- nozzle for sprayer **CB230357** – 1 pc.
- valve holder **CB230355** – 1 pc.
- bracket **CB220007** for valve holder – 1 pc.
- Timing valve - 1 pc.
- Metering valve – 1 pc.
- steel braided hose – 2 pcs.
- fitting for a hose - 4 pcs.
- fitting to the adapter - 2 pieces;
- rubber-metal gasket - 4 pcs.
- pressure nozzle - 1 pc.

**DL-CB20155**

**Clamp for injectors Delphi E1 (John Deere)
to Cam Box 2 of the DORPAT stand**

Delivery set: clamp - 1 pc, fitting - 2 pcs,
rubber-metal. gasket - 4 pcs.

Nozzle not included.

**DL-CB20156**

Clamp adapter for testing unit injectors CAT 3920206

Delivery set: clip - 1 pc, fixing bracket - 1 pc
fixing bolt of the clamp-lock 8x35 - 2 pcs
fitting - 2 pcs, rubber-metal. gasket - 4 pcs

Nozzle not included.

**DL-CB20157**

**Test adapter clamp
pump injector Cummins 3053124**

Delivery set: clamp - 1 pc, fitting - 2 pcs,
rubber-metal. gasket - 4 pcs.

Nozzle not included.

CAM-BOX 2 MECHANIC

OPTIONAL EQUIPMENT



DL-CB2 50037

Injection sensor for unit injectors
Cummins HPI



DL-CB250036KIT

injection sensor
(piezo)



DL-CB20158

Adapter clip for injectors
CUMMINS 4902827

Scope of delivery:

DL-CB231672 adapter clip № 0158 — 1 pc;

DL-CB231675 bracket-retainer — 1 pc;

DL-CB230357 nozzle on the sprayer — 1 pc;

DL-UNI30035 fitting for the adapter clip M14x1,5x1/4" — 3 pcs;

D-GM1538AN rubber-metal gasket ØM14 — 3 pcs;

D-GM1504AN rubber-metal gasket Ø1/4" — 3 pcs.

Nozzle not included.



25-FPKM-04

Fitting - quick adapter
for adapter



25-FPKF-04

Hydraulic Quick Connector
female connections 1/4"



D-1324179

Pusher for Cam-Box2

CAMBAT-FLOW

Injection meter for pump injectors of pump sections of the UIS/UPS system (for UIS-Tester MULTICAM).

**UIS-TESTER MultiCAM**

The UIS-Tester device is designed to test and verify the performance of unit injectors (UIS -Unit Injector System) and individual high-pressure fuel pumps with high-pressure solenoid valves (UPS -Unit Pump System).

CAMBAT-FULL

Equipment for testing and checking unit injectors and pump sections of the UIS / UPS system without a mechanical part.



**Equipment CAMBAT-FULL
includes:**

1. Rack with measuring unit CAMBAT-FLOW
2. Control device for pump-injectors of pumping sections UIS-Tester MULTICAM
3. A set of connecting wires for injectors, measuring unit, etc.

CAMBAT-FULL-SET

Equipment for testing and checking the pump injector of pump sections of the UIS / UPS system with a mechanical part.

**Equipment CAMBAT-FULL-SET
includes:**

1. Rack with measuring unit CAMBAT-FLOW
2. Control device for unit injectors and pump sections UIS-Tester MULTICAM
3. A set of connecting wires for injectors, measuring unit, etc.
4. The mechanical part for testing the pump-injector pump sections CAM-BOX MECHANIC



DL-ST02

Clamp for dismantling and assembling the unit injector of CR injectors with two stops on atomizer nozzles with \varnothing 7mm, with \varnothing 9mm.

Contents of delivery:

1. Rack **STD50115** - 1 pc.
2. Large vice **STD50116** - 1 pc.
3. Replaceable foot **STD30498** - 2 pcs.
4. Guide post **STD30540** - 1 pc.
5. Small vice **STD50117** - 1 pc.
6. Stop \varnothing 7mm **STD30148** - 1 pc.
7. Stop \varnothing 9mm **STD30147** - 1 pc.
8. Replaceable foot **STD30752** - 2 pcs.
9. Bracket **STD30610** - 1 pc.
10. Handle **STD30811** - 3 pcs.
11. Clamping screw **STD30810** - 1 pc.
12. Holder **STD30813** - 1 pc.
13. **STD30812** axle - 1 pc.
14. Retainer **STD30468** - 3 pcs.
15. Screw **M4x8 Din012** - 4 pcs.
16. Screw **M4x16 Din012** - 1 pc.
17. Screw **M4x20 Din012** - 2 pcs.
18. Nut M20 **Din034** - 2 pcs.
19. Washer 21x37x3 **Din0125** - 2 pcs.
20. Grover 20 **Din127** - 2 pcs.
21. Bolt M10x30 **Din033** - 4 pcs.
22. Nut M10 **Din034** - 4 pcs.
23. Washer 10.5x20x2 **Din0125** - 4 pcs.
24. Grover10 **Din127** - 4 pcs.
25. Viewfinder for goniometer **DL-STD30874**
26. Axis under the sight **DL-STD30873**
27. Clamp **STD50010** VW1.9 - 1 pc.
28. Clamp **STD50009** VW2.0 - 1 pc.
- 29-1. Short stand **STD31245** – 2 pcs.
- 29-2. Extended stand **STD30657** – 2 pcs.
30. Stop **STD30678** - 1 pc.
31. Bolt **STD30658** - 1 pc.
32. **STD30656** bar - 1 pc.
33. Stop **STD30673** - 1 pc.
34. Holder AT **STD50077** - 1 pc.
35. Speaker holder **STD50078** - 1 pc.
36. Rack **STD30672** - 1 pc.
37. **STD30671** bar - 1 pc.



**Clamp installation
unit injector AUDI / VW 1.9**



**Clamp installation
injector pump
SCANIA H-shaped**



**Installation in a tube
injector pump
VOLVO Delphi 2x and 4x contact**



**Clamp installation
injector pump
SCANIA**



**Clamp installation
pump section Delphi 082240354**



**Clamp installation
pump section
DAF Bosch 0414755005**



**Clamp installation
pump section MV ATEGO**



**Clamp installation
pump section MV ACTROS**

OPTIONAL CLAMP DL-ST02

**DL-STD50206**

Injector holder
AUDI / VW 1.9 to adjust
el. magnetana clamp
ST-01 / ST-02

**DL-STD50207**

Injector holder
AUDI / VW 2.0 to adjust
el. magnetana clamp
ST-01 / ST-02



**DL-UIS50144**

Key for positioning the electromagnet in the pump injectors BOSCH AUDI / VW 1.9

Contents of delivery:

- Key for electromagnet
- Key positioner

Analog BOSCH 0986610318

**DL-UIS50195**

Key for positioning the electromagnet in the pump injectors BOSCH AUDI / VW 2.0

Contents of delivery:

- Key for electromagnet
- Key positioner

Analog BOSCH 0986610318

**DL-UIS30745****(8 faces, 38mm)**

Wrench for mounting / dismounting the electromagnet nut valve injector pump Bosch (Iveco, Scania, Volvo)

**DL-UIS31438****(12 faces, 39mm)**

Wrench for mounting / dismounting the electromagnet nut valve injector pump Bosch (Volvo)

**DL-UIS30693**

Hex wrench for mounting / dismounting the nut injector nozzle Audi / VW1,9

Applicability:

PDE-P1,PDE-P1,1,PDE-P1,3,PDE-P1,4

**DL-UIS30724**

Wrench for mounting / dismounting the atomizer nut unit injectors Audi / VW 2.0 TDI Bosch

Applicability:

414720403, 0414720404

**DL-UIS30725**

Octagonal wrench for mounting / dismounting the nut atomizer pump-injector Audi / VW 1.9-5.0 PDE-P1.5.

Applicability:

0414720309-2.5, 0414720359-2.5, 0414720310-2.5, 0414720360-2.5, 0414720305-5.0, 0414720301-5.0, 0414720311-5.0, 0414720361-5.0, 0414720306-2.0, 0414720302-2.0, 0414720312-2.0, 0414720362-2.0, 0414720307-1.9, 0414720303-1.9, 0414720313-1.9, 0414720363-1.9, 0414720308-1.9, 0414720304-1.9, 0414720314-1.9, 0414720364-1.9

**DL-UIS30751**

Octagonal wrench 17mm for atomizer nut unit injectors Audi / VW Siemens VDO (PIEZO)

**DL-UIS30726**

Wrench for mounting / dismantling the electromagnet nut
unit injectors Audi / VW 2.0

Applicability:
0414720403, 0414720404

**DL-UIS30733**

Wrench for mounting / dismantling the electromagnet nut
unit injector Audi / VW 1.9

Applicability:
0414720029-0414720215

**DL-UNI30667**

29 mm hex wrench for mounting / dismantling
AUDI / VW injector housing nuts

Applicability:
0414720400, 0414720401, 0414720402, 0414720403,
0414720453, 0414720454

**DL-UNI30668**

Key 30 mm octagonal for mounting / dismantling
VW SIEMENS injector housing nuts



**DL-UNI50011**

**Wrench for mounting / dismantling the spray nut
Ø 27 mm injectors Volvo, Delphi, Lucas**
(for torque wrench)

**DL-UNI50313**

**Wrench for mounting / dismantling the spray nut
Ø 28 mm unit injector Cummins 3053124**
(for torque wrench)

**DL-UNI50127**

**Wrench for mounting / dismantling the spray nut
Ø 29.4 mm injectors Caterpillar C12, C15**
(for torque wrench)

**DL-UNI50012**

**Wrench for mounting / dismantling the spray nut
Ø 31.5mm Cummins (Scania) HPI injectors**
(for torque wrench)

**DL-UNI50048**

**Wrench for mounting / dismantling the nut
Ø 36.2 mm PLD sections Delphi 1668325**
(for torque wrench)

**DL-UNI30763**

**Wrench for mounting / dismantling the spray nut
Ø 32mm Bosch unit injectors**

Applicability:

0414701005, 0414701006, 0414701008, 0414702002,
0414702007, 0414702010, 0414703008

**DL-UIS30880**

**Caterpillar injector holder adapter
C12, C15 in a vice**

**DL-UIS50143**

Valve Stroke Kit
unit injector AUDI / VW BOSCH 1.9/2.0

Contents of delivery:

1. **DL-UIS31069** Double-sided clip
2. **DL-UIS31070** Measuring head adapter.
3. **DL-UIS31071** The washer is stubborn.
4. **DL-UIS31072** Calibration plate
5. **DL-CRN30503** Measuring probe

ATTENTION!

*Measuring indicator head in
delivery set is not included!*

**DL-UIS30827**

Stand adapter for indicator
for measuring the air gap in the housing
injector pump

**DL-UIS50102**

Adapter for indicator
for stroke measurement
injector valve
Bosch

**DL-UIS50100**

Wrench for mounting / dismantling and adjustment
pump-injector solenoid nuts
Audi / VW 1.9 TDI (Bosch) on the stand.
Applicability: 0414720029 -0414720215

**DL-UIS50101**

Wrench for mounting / dismantling and adjustment
pump-injector solenoid nuts
Audi / VW 2.0 TDI

**DL-VW10SMFULL****SET OF KEYS FOR DISASSEMBLY-ASSEMBLY OF PUMP INJECTORS AUDI / VW****1. DL-UIS30667**

Wrench 29mm hex for mounting / dismantling the nut of the unit injector housing
AUDI / VW 2.0 , PDE-P2.

Applicability: 0414720400 0414720401 0414720402 0414720403 0414720453 0414720454

2. DL-UIS30668

Wrench 30 mm octagonal for mounting / dismantling the nut of the unit injector housing
VW Siemens

3. DL-UIS50100

Wrench for mounting / dismantling and adjusting the nut of the electromagnet of the unit injector
Audi / VW 1.9-5.0 (Bosch) on the stand.

Applicability: 0414720029-0414720215

4. DL-UIS30726

Wrench for assembly / disassembly of the solenoid nut of the pump injector Audi / VW 2.0 Bosch

Applicability: 0414720403 0414720404

5. DL-UIS30725

Octagonal wrench for mounting / dismantling the nozzle nut of the unit injector
Audi/ VW 1.9-5.0, PDE-P1.5.

Applicability: 0414720309-2.5 l. 0414720359-2.5 l. 0414720310-2.5 l.

0414720360-2.5 l. 0414720305-5.0 l. 0414720301-5.0 l. 0414720311-5.0l. 0414720361-5.0l.

0414720306-2.0 l. 0414720302-2.0 l. 0414720312-2.0 l. 0414720362-2.0 l. 0414720307-1.9 l.

0414720303-1.9 l.0414720313-1.9 l. 0414720363-1.9 l. 0414720308-1.9 l. 0414720304-1.9 l.

0414720314-1.9 l.0414720364-1.9 l.

6. DL-UIS30693

Hexagonal wrench for mounting / dismantling the sprayer nut of the unit injector

Audi / VW 1.9, PDE-P1 PDE-P1.1 PDE-P1.3 PDE-P1.4

7. **DL-UIS50101**

Wrench for adjusting the solenoid nut NF Audi / VW 2.0

8. **DL-UIS30733**

Wrench for mounting / dismantling the nut of the electromagnet of the unit injectors Audi / VW 1.9 TDI Bosch
Applicability: 0414720029-0414720215

9. **DL-UIS30724**

Wrench for mounting / dismantling the sprayer nut of the pump injector Audi / VW 2.0 Bosch
Applicability: 0414720403 0414720404

10. **DL-UIS30751**

Octagonal wrench 17mm for Audi / VW injector nozzle nut
Siemens VDO (PIEZO)

11. **DL-UIS30757**

Dodecahedral key for mounting / dismantling of the piezoelectric element.

**DL-VW2-SVDO****Tool kit for disassembly-assembly NF Audi/VW Siemens VDO**1. **DL-UIS30668**

Wrench 30 mm octagonal for mounting / dismantling the nut of the VW SIEMENS unit injector body

2. **DL-UIS30751**

Octagonal wrench 17mm for Audi / VW Siemens VDO (PIEZO) sprayer nut

3. **DL-UIS30757**

Dodecahedral key for installation / dismantling of the piezoelectric element NF Siemens VDO

**DL-VW PDE****TOOL KIT FOR DISASSEMBLY-ASSEMBLY NF AUDI / VW1,9 PDE-P1.5**

1. **DL-UIS50100**
Wrench for mounting / dismounting and adjusting the nut of the electromagnet of the unit injector Audi / VW 1.9-5.0 (Bosch) on the stand.
Applicability: 0414720029-04147202152
2. **DL-UIS30733**
Wrench for mounting / dismounting the nut of the electromagnet of the pump injectors Audi / VW 1.9 Bosch TDI.
Applicability: 0414720029-0414720215
3. **DL-UIS30725**
Octagonal wrench for mounting / dismounting the nozzle nut of the unit injector Audi/VW 1.9-5.0, PDE-P1.5.
Applicability: 0414720309-2.5 l. 0414720359-2.5 l. 0414720310-2.5 l. 0414720360-2.5 l. 0414720305-5.0 l. 0414720301-5.0 l. 0414720311-5.0l. 0414720361-5.0l. 0414720306-2.0 l. 0414720302-2.0 l. 0414720312-2.0 l. 0414720362-2.0 l. 0414720307-1.9 l. 0414720303-1.9 l.0414720313-1.9 l. 0414720363-1.9 l. 0414720308-1.9 l. 0414720304-1.9 l. 0414720314-1.9 l.0414720364-1.9 l.
4. **DL-UIS30693**
Hexagonal wrench for mounting / dismantling the nut of the Audi / VW 1.9 injector sprayer PDE-P1 PDE-P1.1 PDE-P1.3 PDE-P1.4

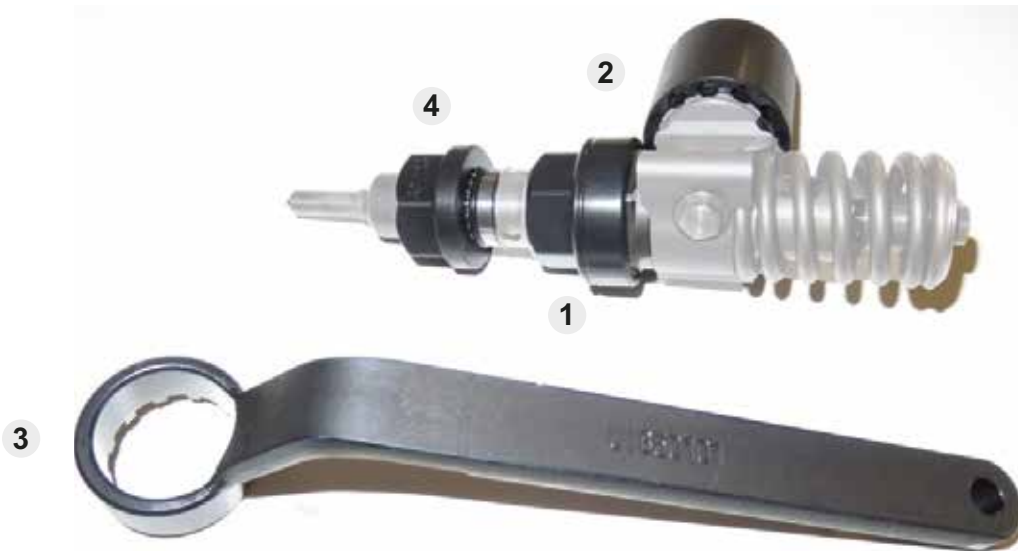
**DL-VW-PDE-2****Tool kit for disassembly-assembly NF Audi / VW 2.0**

1. **DL-UIS30667**
Wrench 29mm hex for mounting / dismantling the nut of the unit injector housing
AUDI / VW 2.0 , PDE-P2. Applicability: 0414720400 0414720401 0414720402 0414720403
0414720453 0414720454
2. **DL-UIS30726**
Wrench for mounting / dismantling the solenoid nut of the pump injector Audi / VW 2.0 Bosch.
Applicability: 0414720403 0414720404
3. **DL-UIS50101**
Wrench for adjusting the solenoid nut NF Audi / VW 2.0
4. **DL-UIS30724**
Wrench for assembly / dismantling of the nozzle nut of the pump-injector Audi / VW 2.0 Bosch
Applicability: 0414720403 0414720404

**DL-UIS30590**

Adapter for testing the injector part
Bosch injectors (Scania, Volvo,
IVECO CURSOR TYPE 350).

**DL-UIS30591**

Adapter for testing the injector part
pump-injector Bosch (Volvo).

**DL-UIS30594**

Adapter for testing the injector part
pump-injector Volvo 520 CV.

**DL-UIS30597**

Adapter for testing the injector part
pump-injector Delphi (Volvo Tape A).

**DL-UIS30598**

Adapter for testing the injector part
pump injector Detroit .

**DL-UIS30606**

Adapter for testing the injector part
pump injectors Cummins L10-M11.

**DL-UIS30627**

Adapter for testing the injector part
injectors Volvo 460 2 tape, Scaniapumps.

**DL-UIS30631**

Adapter for testing the injector part
pump injectors EUI / PDE Cummins N14 pumps.

**DL-UIS30634**

Adapter for testing the injector part
unit injector EUI / PDE Audi, VW 2. (2.0 liters)

**DL-UIS50082**

Adapter for testing the injector part
pump injectors EUI / PDE Audi, VW pumps all
types except EUI / PDE Audi, VW 2. (2.0 liter)

**DL-UIS30643**

Adapter for testing the injector part
unit injector EUI / PDE Iveco Stralis 500 HP.
0414703004, 0414703008, 0414703010.

**DL-UIS30640**

Adapter for testing the injector part
Cummins pump injectors.

**DL-UIS30635**

Adapter for testing the injector part pump injector Volvo Delphi 4PIN.

**DL-UIS50079**

Injector test adapter injectors Audi, VW. 04147203XX for assembly on a clamp.

**DL-UIS50081**

Adapter for testing the injector part injector pump Audi, VW. 04147200XX, 04147202XX, 04147204XX, 04147206XX for assembly on a clamp.

**DL-UIS30638**

Adapter for testing the injector part unit injectors EUI / PDE Audi, VW 2. (2.0 liters). 1 681 398 033 for assembly on a clamp.

**DL-UIS30662**

Adapter for testing the injector part pump injectors Audi, VW Siemens VDO piezo for assembly on a clamp.

**DL-UIS30770**

Adapter for testing the injector part unit injector EUI / PDE Nissan 440 (M31x1).

**DL-UIS31507**

Adapter for testing the injector part of the pump injector EUI / PDE HYUNDAI 22880-84001(M28x1)

АДАПТЕРЫ ДЛЯ CATERPILLAR

**DL-UIS30789**

Adapter for testing the injector part
injector pump EUI / PDE HEUICAT 3126
The adapter has a connecting thread M28x1

**DL-UIS30768**

Adapter for testing the injector part
unit injector EUI / PDE Caterpillar series 3500
The adapter has a connecting thread M27x1.5

**DL-UIS30769**

Adapter for testing the injector part
injector unit EUI / PDE Caterpillar Marino Adapter
has a connecting thread M36x1.5

**DL-UIS30897**

Adapter for testing the injector part
unit injectors EUI / PDE CAT C15, C16.
The adapter has a connecting thread M33x1.5

**DL-UIS31441**

Adapter for testing the injector part
unit injector Caterpillar CAT C12
The adapter has a connecting thread M28x1

**DL-UIS31511**

Adapter for testing the injector part of the pump
injectors EUI / PDE Caterpillar CAT3112
The adapter has a connecting thread M36x1.5 and
longer than DL-UIS30769

**DL-UIS31559**

Adapter for testing the injector part of the pump
injectors CAT M32. The adapter has a connection
thread M32x1.5mm
Has two holes for atomizer pins.

ADAPTERS FOR CATERPILLAR

**DL-TRUKUSA-04CAT**

**Test Adapter Kit
injector part of unit injectors
american trucks
manufactured by CATERPILLAR.**

- DL-UIS30789
- DL-UIS30768
- DL-UIS30769
- DL-UIS30897

**DL-TRUKUSA-05CAT**

**Set of adapters for checking the injector
truck injector parts
American made CATERPILLAR**

- DL-UIS30789
- DL-UIS30768,
- DL-UIS30769
- DL-UIS30897
- DL-UIS31441

**DL-TRUKUSA-06CAT**

**Set of adapters for checking the injector
truck injector parts
American made CATERPILLAR**

- DL-UIS30789
- DL-UIS30768
- DL-UIS30769
- DL-UIS30897
- DL-UIS31441
- DL-UIS31511

**DL-TRUKUSA-07CAT**

**Set of adapters for checking the injector
truck injector parts
American made CATERPILLAR**

- DL-UIS30789
- DL-UIS30768
- DL-UIS30769
- DL-UIS30897
- DL-UIS31441
- DL-UIS31511
- DL-UIS31559

ADAPTER SETS FOR CHECKING THE INJECTOR PART

**DL-TRUSA-04BR****Set of adapters for checking the injector truck injector parts**

American production CUMMINS and DETROIT.
(DL-UIS30598-DETROIT, DL-UIS30606-CUMMINS L10-M11, DL-UIS30631-CUMMINS N14, DL-UIS30640-CUMMINS)

**DL-TRUKE-07BR****Test Adapter Kit injector part of unit injectors European cars.**

(DL-UIS30590 - BOSCH (Scania, Volvo, Iveco Cursor), DL-UIS30591 - BOSCH (Volvo), DL-UIS30594 - Volvo 520CV, DL-UIS30597 - DELPHI (Volvo Tape A), DL-UIS30627 - (Volvo 460 Tape 2, Scania), DL-UIS30635 - DELPHI (Volvo 4 Pin), DL-UIS30643 - (Iveco Stralis 500HP)

**DL-VW-4BR****Set of adapters for checking the injector AUDI / VW car injector parts**

all types. (DL-UIS50079-AUDI/VW 04147203XX, DL-UIS50081-AUDI/VW 04147200XX, 04147202XX, 04147204XX, 04147206XX, DL-UIS30638-EUI / PDE AUDI/VW 2.0 Liter (TYPE2), DL-UIS30662-AUDI / VW SIEMENS VDO piezo)

**DL-RP400****Manual press for injector testing with mechanical pressure gauge****Contents of delivery:**

- mechanical press - 1 pc.
- mechanical pressure gauge - 1 pc.
- connecting tube – 2 pcs.

**DL-RP410** (without pressure sensor)**DL-RP415** (with pressure sensor. 1500 bar)**Manual press for injector testing with electronic pressure gauge****Contents of delivery:**

- mechanical press - 1 pc.
- connecting tube – 2 pcs.
- electronic pressure gauge with cable - 1 pc.
- battery charger - 1 pc.
- pressure sensor (for **RP 415**) for 1500 bar – 1 pc.

**DL-RP420** (without pressure sensor)**DL-RP425** (with pressure sensor. 1500 bar)**Manual press for injector testing with 2-channel electronic pressure gauge****Contents of delivery:**

- mechanical press - 1 pc.
- connecting tube – 2 pcs.
- electronic pressure gauge with cable - 1 pc.
- battery charger - 1 pc.
- pressure sensor (for **RP 425**) for 1500 bar – 1 pc.

**DL-RP430****Manufacturer - ZECA (Italy)
Flame test chamber (aspirator)
nozzle spray**

Allows for visual inspection performance of diesel injectors without harm to health. The device is going to work liquid for reuse.

**DL-RP500**

Manufacturer - ZECA (Italy)
Manual press for injector testing with mechanical pressure gauge

Contents of delivery:

- mechanical press - 1 pc.
- mechanical pressure gauge - 1 pc.
- connecting tube - 2 pcs.



DL-RP510 (without pressure sensor)

DL-RP515 (with pressure sensor. 1500 bar)

ZECA hand press for injector testing with electronic pressure gauge

Contents of delivery:

- mechanical press - 1 pc.
- connecting tube – 2 pcs.
- electronic pressure gauge with cable – 1 pc.
- battery charger - 1 pc.
- pressure sensor (for RP 515) for 1500 bar – 1 pc.



DL-RP520 (without pressure sensor)

DL-RP525 (with pressure sensor. 1500 bar)

ZECA hand press for injector testing with 2-channel electronic pressure gauge

Contents of delivery:

- mechanical press - 1 pc.
- connecting tube – 2 pcs.
- electronic pressure gauge with cable – 1 pc.
- battery charger - 1 pc.
- pressure sensor (for RP 525) for 1500 bar – 1 pc.

**DL-UIS50150**

A set of diamond laps and reamers for restoring the landing BOSCH unit injector valve locations.

Contents of delivery:

1. **DL-UIS1368063** Diamond conical lap with pilot (L 136°) 80/63
2. **DL-UIS1364028** Diamond conical lap with pilot (L 136°) 40/28
3. **DL-UISPA78063** Diamond reamer RA $\varnothing 7$ 80/63
4. **DL-UISPA74028** Diamond reamer RA $\varnothing 7$ 40/28
5. **DL-UIS50193** Guide puller with split sleeve
6. **DL-UIS50247** Diamond reamer jacket puller
7. **DL-UNI30975** Handle for lapping - 2 pcs.
8. **DL-UNI30978** Handle fixing screw - 2 pcs.

**Injector valve for
VOLVO, SCANIA, IVECO:**

- D-GR02X \ 136 \ 7,010
- D-GR02X \ 136 \ 7,015
- D-GR02X \ 136 \ 7,020
- D-GR02X \ 136 \ 7,025
- D-GR02X \ 136 \ 7,030
- D-GR02X \ 136 \ 7,035
- D-GR02X \ 136 \ 7,040
- D-GR02X \ 136 \ 7,045
- D-GR02X \ 136 \ 7,050
- D-GR02X \ 136 \ 7,055
- D-GR02X \ 136 \ 7,060
- D-GR02X \ 136 \ 7,070
- D-GR02X \ 136 \ 7,080

**DL-UIS50256**

**Set of diamond laps and reamers
to restore a seat
BOSCH unit injector valves**

Contents of delivery:

1. Diamond conical lap (L 136°) "coarse" - 1 pc.
2. Diamond conical lap (L 136°) "finish" – 1 pc.
3. Pilot for lapping diamond conical - 2 pcs.
4. Diamond reamer - 1 pc.
5. Pilot for reaming - 1 pc.
6. Handle to hold the pilot - 1 pc.
7. Cap for pressing on the reamer and laps - 3 pcs.
8. Brush for cleaning the NF valve channel - 1 pc.
9. Organizer - 1 pc.

**DL-UIS50257**

**Set of diamond laps and reamers
to restore a seat
DETROIT unit injector valves**

Contents of delivery:

1. Diamond conical lap "coarse" - 1 pc.
2. Diamond taper lap "finish" - 1 pc.
3. Pilot for lapping diamond conical - 2 pcs.
4. Diamond reamer - 1 pc.
5. Pilot for reaming - 1 pc.
6. Handle to hold the pilot - 1 pc.
7. Cap for pressing on the reamer and laps - 3 pcs.
8. Brush for cleaning the NF valve channel - 1 pc.
9. Organizer - 1 pc.

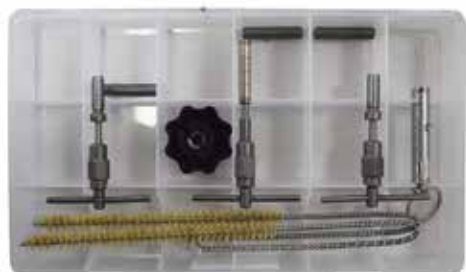
**DL-UIS50255**

**Set of diamond laps and reamers
to restore a seat
BOSCH unit injector valves**

Contents of delivery:

1. Diamond conical lap (L 136°) "coarse" - 1 pc.
2. Diamond conical lap (L 136°) "finish" – 1 pc.
3. Pilot for lapping diamond conical - 2 pcs.
4. Diamond reamer - 1 pc.
5. Pilot for reaming - 1 pc.
6. Handle to hold the pilot - 1 pc.
7. Cap for pressing on the reamer and laps - 3 pcs.
8. Brush for cleaning the NF valve channel - 1 pc.
9. Flashlight - 1 pc.
10. Organizer - 1 pc.

ОСНАЩЕНИЕ И ИНСТРУМЕНТ ДЛЯ ПРОВЕРКИ И РЕМОНТА НАСОС-ФОРСУНОК HEUI

HEUI CATERPILLAR 3126B,
CATERPILLAR 3126E и FORD 1998-2003
DIESEL 7.3 FUEL INJECTOR 128-6601,
AD1831489C1 (INTERNATIONAL)



Equipment includes:

1. **DL-HEUI50223** Pump installation adapter nozzles



2. **DL-HEUI50240** Set of hydraulic hoses and HPT 400mm 14x14mm
3. **DL-HEUI50219** Adapter holder with clamping bar
4. **DL-HEUI50230** Adapter cable for connecting the pump injector
5. **DL-UNI50084** Corner adapter M14



Attention! All accessories are sold separately.

HEUI CATERPILLAR C7-C9



Equipment includes:

1. **DL-HEUI50221** Pump installation adapter nozzles



EQUIPMENT AND TOOLS FOR CHECKING AND REPAIRING HEUI INJECTORS

**DL-UNI50208**

Wrench for unscrewing the atomizer nut injectors Caterpillar C7-C9.
Key working diameter 24 mm

**DL-UIS30789**

Adapter for testing the injector part injector pump EUI / PDE HEUICAT 3126
The adapter has a connecting thread M28x1

**DL-HEU50251**

Seal kit
HEUI CAT C7-C9 unit injector rings

**DL-HEUI31342**

Upper case for pump-injector installations high pressure supply.

**DL-HEU31332**

Lower housing for low pressure supply

**DL-HEU50227**

Protective screen with cover from polycarbonate.
(DL-HEU31333 Protective polycarbonate screen)
(DL-HEU31334 Lid protective screen)

**DL-HEU31335**

Conical washer clamping (2 pcs)

SPF: 708, 712, 1108, 1112, 1508, 1512

The assay stand is designed for testing and adjusting with increased accuracy of in-line injection pumps, V-shaped injection pumps, distribution-type injection pumps with independent and forced lubrication systems, a pressurization corrector of all domestic manufacturers and major foreign ones: "BOSCH", "LUCAS", "ZEXEL", NIPPON DENSO.

When using additional equipment, the stand allows you to test and check:

- Common-Rail injectors (BOSCH, DELPHI, DENSO, SIEMENS)
- Common-Rail pumps (CP1, CP2, CP3) (BOSCH, DELPHI, DENSO)
- regulators and pressure sensors CR-pump-injectors of European and American cars
- electronic pumps such as VE, VP, Zexel, PE.

Stands are produced with a power of 7.5 kW (**SPF-308, SPF-712**), 11 kW (**SPF-1108, SPF-1112**), 15kW (**SPF-1508, SPF-1512**).

Stands **SPF-708, SPF-1108** and **SPF-1508** have an 8-section measuring block.
Stands **SPF-712, SPF-1112** and **SPF-1512** have a 12-section measuring block.

The stand is equipped with:

- integrated personal computer
- monitor
- control panel of the stand and booster pump
- protective fence with 2 doors made of polycarbonate
- cooling unit of radiator-fan type for 2 channels
- cooling unit of radiator-fan type for 1 channel



SPF

STAND EQUIPMENT



Flexible pipes 3/8"
L-105cm (2 pieces)



Tips
14 mm (2 pcs.)



Tips
by 12 mm (2 pcs.)



Connecting hose
Ø 8 mm L-150 cm (1 pc.)



Connecting hose
Ø 10 mm L-150 cm (1 pc.)



Double-sided key
"ratchet" (1 pc.)



Leg (foot with adjustable
bolt) (4 pcs.)



Door key (4 pcs.)

PTB-3, PTB-5 ,PTB-7, PTB-9, PTB-12

The assay stand is designed for testing and adjusting with increased accuracy of in-line injection pumps, V-shaped injection pumps, distribution-type injection pumps with independent and forced lubrication systems, a pressurization corrector of all domestic manufacturers and major foreign ones: "BOSCH", "LUCAS", "ZEXEL", NIPPON DENSO.

When using additional equipment, the stand allows you to test and check:

- Common-Rail injectors (BOSCH, DELPHI, DENSO, SIEMENS)
- Common-Rail pumps (CP1,CP2,CP3) (BOSCH,DELPHI,DENSO)
- Regulators and pressure sensors CR
- injectors of European and American cars
- electronic pumps such as VE, VP, Zexel, PE.

Stands are produced with capacity:

- PTB-3 - 15 kW
- PTB-5 - 18 kW
- PTB-7 - 22 kW
- PTB-9 - 30 kW
- PTB-12 - 37kW



PTB14

with additional oil station and tank

The assay stand is designed for testing and adjusting with increased accuracy of in-line injection pumps, V-shaped injection pumps, distribution-type injection pumps with independent and forced lubrication systems, a pressurization corrector of all domestic manufacturers and major foreign ones: "BOSCH", "LUCAS", "ZEXEL", NIPPON DENSO.

When using additional equipment, the stand allows you to test and check:

- Common-Rail injectors (BOSCH, DELPHI, DENSO, SIEMENS)
- Common-Rail pumps (CP1,CP2,CP3) (BOSCH,DELPHI,DENSO)
- Regulators and pressure sensors CR
- injectors of European and American cars
- electronic pumps such as VE, VP, Zexel, PE.

The stand is produced with a capacity of 45 kW



Stands of the **PTB** series for checking high-pressure fuel pumps allow you to perform all procedures related to testing and adjusting high-pressure fuel pumps in accordance with international ISO standards:

- drive system with smooth speed control;
- power supply system with smooth pressure regulation;
- pneumatic system with smooth pressure adjustment;
- a block for measuring the dosage of the strait;
- fastening elements of tested pumps.

The design of the injection pump test bench and its equipment elements meet the requirements of international standards in terms of static and dynamic parameters - ISO4008/1 and ISO4008/2

Technical data of PTB series stands:

rotational speed	30–3000min ⁻¹
direction of rotation	left / right
engine power (nom.)	from 15kW to 45kW by modification
programmable number of shots	50–1000
tank capacity	30-160 dm ³ by modification
number of sections	eight
measuring beaker capacity	44 and 260 +/- 0.25cm ³
supply voltage	3x400V/230V~50Hz
shut-off valve supply	12V / 24V
distance from the plate to the axis of the drive	125mm-170mm by modification
compensation sleeve diameter	110mm
feed pump performance assay oil at 3bar	6,5dm ³
high pressure gauge	0÷10Bar
maximum current	24.5A (38.5A) by modification
total weight and dimensions L(length) x B(width) x H(height)	1830 x 1710(900) x 1670

OPTIONAL EQUIPMENT AND ACCESSORIES
TO STANDS FOR CHECKING FUEL PUMPS OF HIGH PRESSURE**DL-MSP**

Mobile oil station
for stands



Frequency
converter
for stands:

- 2,2 kW
- 4 kW
- 5,5 kW
- 7,5 kW
- 11 kW
- 15 kW

OPTIONAL EQUIPMENT AND ACCESSORIES TO STANDS FOR CHECKING FUEL PUMPS OF HIGH PRESSURE



MZK-45

**Measuring cylinder 45ml
(beaker) for stands
injection pump checks**
Length - 320mm
Diameter - 18mm
Scale – 0-150ml
Division price - 0.2ml



MZK-260

**Measuring cylinder 260ml
(beaker) for stands
injection pump checks**
Length - 320mm
Diameter - 38mm
Scale - 0-260ml
Division price - 2ml



MZK-150

**Measuring cylinder 150ml
(beaker) for stands
injection pump checks**
Length - 320mm
Diameter - 28mm
Scale – 0-150ml
Division price - 1ml



SDMZ-38

**Bracket-holder
for MZK-260 for 260ml**



SDMZ-28

**Bracket-holder
for MZK-150 for 150ml**



SDMZ-18

**Bracket-holder
for MZK-45 for 45ml**



DL-OHL

**Fridge-
stand air conditioner**

OPTIONAL EQUIPMENT AND ACCESSORIES
TO STANDS FOR CHECKING FUEL PUMPS OF HIGH PRESSURE



DL-UNI50132

Compensation clutch with clamping jaws and reinforced package plates



DL-MS9

Coupling slotted for CR injection pump (for Renault slot 9x20)



DL-UNI50139

Compensation clutch with flange connection and reinforced package plates (analogue Bosch 1686401024)



DL-MS10D

Coupling slotted for injection pump CR Denso, slot 10x23



DL-CB230016

Conical coupling with flange connection Ø 30 mm
Cam Box2, injection pump



DL-MS10S

Coupling slotted for Siemens Peugeot injection pump Boxer 2.2, slot 10x21.6



DL-M24 (UNI30127)

Cone coupling Ø 24 mm for injection pump CRSR-3 mod.044502088



DL-MS11

Coupling slotted for injection pump CR MAN (11 splines)



DL-M24L (CR31098)

Long sleeve Ø 24 mm for injection pump DENSO HP0



DL-M17

Cone coupling Ø 17mm for injection pump CR and injection pump VE



DL-M19

Cone coupling Ø 19 mm for CR and VE injection pumps



DL-MS8

Coupling slotted for injection pump CR (for MV slot 8x18)



DL-M23 (UNI30917)

Conical coupling for 23 for injection pump Continental A2C59517053, Bosch CR\CP4HS2 0445010637, CP4S2 0445010611, CP4S1 0445010506

EQUIPMENT AND ACCESSORIES FOR ROTARY AND INLINE injection pumps

**DL-UNI50051-KIT****VE injection pump test kit****Contents of delivery:**

DL-UNI50051	Holder frame for 6 nozzles
DL-TVD-K700	Profile bolt for fastening the frame Injector fixing screws – 6 pcs. Injector holder fastening screws – 2 pcs.
DL-PG(CR26)	Defoamers for spilling liquid - 6 pcs.
34-RL020602	Fitting 6mm x 1/4 for defoamer - 6 pcs.
DL-UNI30452	Nozzle nozzle - 6 pcs.
34-RL020601	Fitting 6mm x 1/8 for nozzle - 6 pcs.
34-RWN-06x04	PVC pipe Ø6mm for connection - 12m

**DL-TVD-M**

High pressure metal tube

DL-TVD-M81412	(800)	M14xM12
DL-TVD-M81414	(800)	M14xM14
DL-TVD-M61412	(600)	M14xM12
DL-TVD-M61414	(600)	M14xM14

EQUIPMENT AND ACCESSORIES FOR ROTARY AND INLINE injection pumps

**DL-UNI30465**

Mounting flange Ø 50/60mm
for high pressure fuel pump VE
and for high pressure fuel pump
CR (BMW, RENAULT, MB,
Peugeot)

**DL-CB130139**

Cone coupling Ø 30 mm
Cam Box2, injection pump

**DL-CR30466**

Mounting flange Ø 68 mm,
for injection pump CR Renault
Megane, Delphi Siemens
VDO, Land Rover,
RangeRoverV8 and for
HPFP VE

**DL-M17**

Cone coupling Ø 17 mm
for CR and VE injection pumps

**DL-UNI30467**

Mounting flange Ø 70mm
for injection pump VE

**DL-M19**

Cone coupling Ø 19 mm
for CR and VE injection pumps

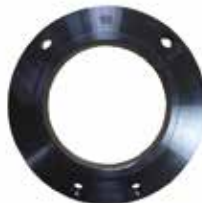
**DL-UNI30521**

Mounting flange Ø 105mm
for injection pump MTZ-50, MTZ-80,
MTZ-82, MTZ-825, T16, T25,
T30, T40, SND-18, SND-17,
SND-14.

**DL-UNI50008**

Bracket for pumps,
Bosch standard 125 mm.
Installed on a stand.

EQUIPMENT AND ACCESSORIES FOR ROTARY AND INLINE injection pumps

**DL-UNI30514**

Mounting kit
to the stand of in-line pumps
Bosch-Kamaz (similar to Bosch1688030141)

Contents of delivery:

- support - 2 pcs.
- profile bolt - 2 pcs.
- nut - 2 pcs.
- washer - 2 pcs.
- grower - 2 pcs.

**DL-UNI30525**

Stand support
in-line pumps MAN double rail
(similar to Bosch1688030184)

Contents of delivery:

- support – 1 pc.
- profile bolt – 1 pc.
- nut - 1 pc.
- washer - 1 pc.
- grower - 1 pc.

EQUIPMENT AND ACCESSORIES FOR ROTARY AND INLINE injection pumps

**DL-UNI50042**

indicator fixture
measuring rack travel in-line
pumps BoschP (P7100, P8500).

**Completed****adapters:**

- 18x1.5 (B, BV pumps)
- 20x1.5 (A pumps)
- 24x1.5 (P pumps)
- 24x1.5 (8500 pumps)

**AAE388-0A**

Comparator for P7000 / 8500 pumps
to determine the height of the start of the feed.
Connection 24x1.5mm.

**DL-UNI50040**

Retainer-eccentric plungers in-line
pumps BoschP (P7100, P7800).

**DL-RD30765**

Wrench for repairing mechanical
nozzles with a 28 mm hexagon.

**DL-RD30766**

Wrench for repairing mechanical
nozzles with hexagon 27mm.

EQUIPMENT AND ACCESSORIES FOR ROTARY AND INLINE injection pumps

**DL-UNI30786 (VP3)**

Coupling for fastening to the pump flange for High pressure fuel pump series VP (Opel)

**DL-UNI30787 (VP4)**

Coupling for fastening to the pump flange for VP series injection pump (Audi / VW, BMW, MB)

**DL-UNI30788 (VP5)**

Coupling for fastening to the pump flange for injection pump series VP (Ford)

**DL-UNI30603 (VP6)**

Coupling for fastening to the pump flange for High pressure fuel pump series VP (Nissan Almera, Tino, Terano 3, Patrol 3.0)

**DL-VPLO**

Lodgment for injection pump VP series, Opel

**DL-VPLA**

Lodgment for injection pump VP, Aud/VW, BMW, MB series

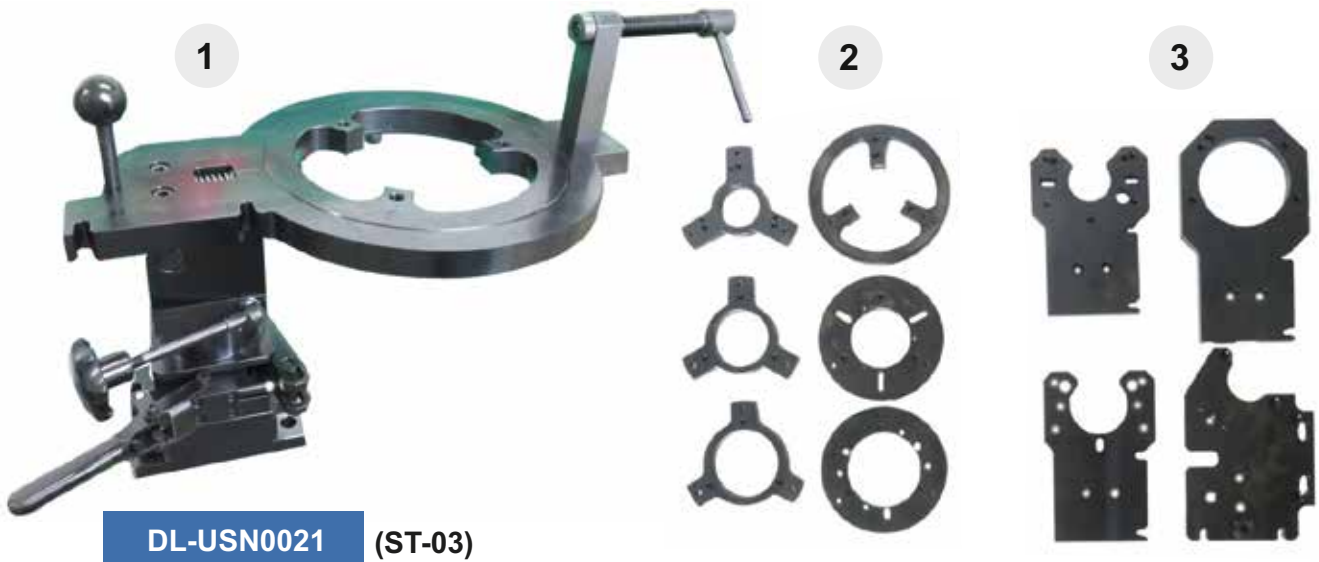
**DL-USN0021 (ST-03)****Universal cradle for CR pumps****Delivery set DL-USN0021 (ST-03):**

1. Rotary stand - 1 pc.
2. Set of flanges for fastening CR pumps of 6 pcs.
3. Set of 4 pump support plates.

Delivery set DL-USN0021CR (ST-03CR):

1. Rotary stand - 1 pc.
2. Set of flanges for fastening CR pumps of 6 pcs.

ATTENTION!

Holder plates for high pressure fuel pumps CR and rotary high pressure fuel pumps are also sold separately!



CR TESTER . CRT-5040



4-channel device for testing and testing Common Rail injectors Bosch, Denso, Delphi, Siemens VDO with a set of cables.

The device has the ability to connect to the FLAGMAN-FLOW beakerless measuring system with the ability to generate correction codes for Delphi C2i / C3i, BOSCH, DENSO injectors

The **CR TESTER. CRT-5040** has the functions of controlling the curtain of the metering unit, stopping the high-pressure pump, measuring and controlling the temperature in the tank, measuring the temperature of the back-tested injectors, measuring the injection start time, etc.

Computer control of the set through the CASCADE software.

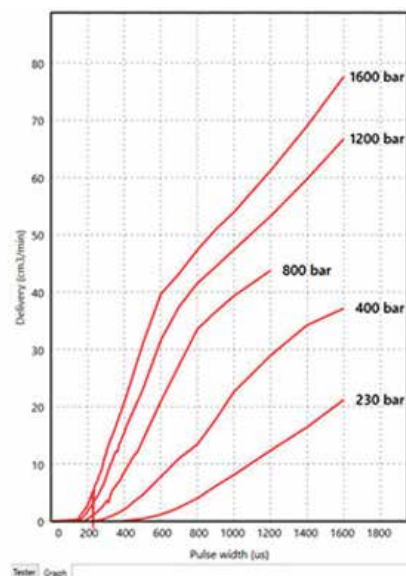
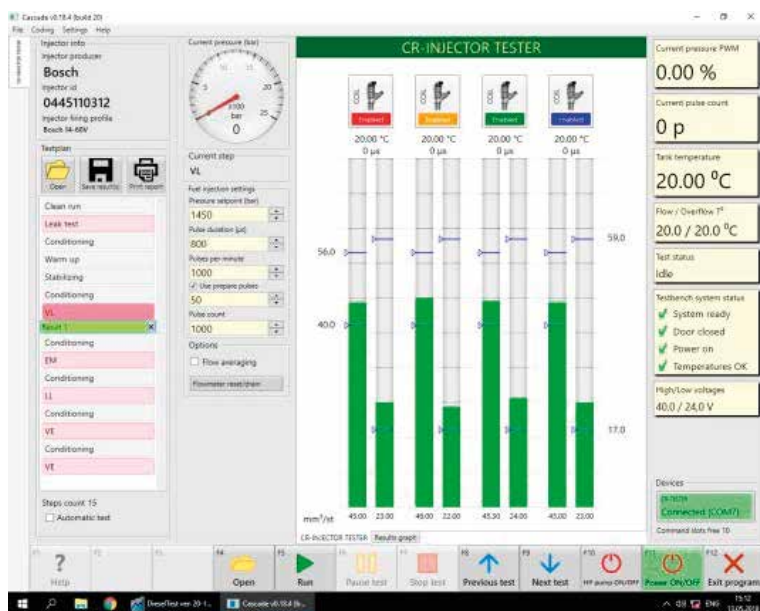



FLAGMAN-FLOW

CR injector dosage measuring unit, 8-channel for CR-TESTER device. CRT-5040

Computer control of the set through the CASCADE software.



FLAGMAN-FULL

CR injector test kit

The FLAGMAN-FULL complex is intended for testing CommonRail injectors manufactured by Bosch, Denso, Delphi, Siemens VDO at the stand.

The measurement takes place in an 8-channel FLAGMAN-FLOW system without a beaker. There is a possibility of retrofitting with a hardware-software complex for coding injectors.

Computer control of the set through the CASCADE software.



FLAGMAN-CODE (FLAGMAN-CODE-L)

CR injector test kit

The FLAGMAN-CODE complex is designed to test common rail injectors manufactured by Bosch, Denso, Delphi, Siemens VDO at the stand.

The measurement takes place in the 8-channel FLAGMAN-FLOW system without beakers. The complex consists of a FLAGMAN-FLOW measuring unit and a CR-TESTER controller. CRT-5040. The complex is also equipped with a vacuum system for coding Deiphi C2i, C3i injectors. Computer control of the set through the CASCADE software.

The FLAGMAN-CODE-L kit is equipped with equipment for installing injectors on a test bench.



DL-CR50015

Sensor for coding



FLAGMAN-CODE

CR injector test kit

The FLAGMAN-FULL complex is designed for diagnosing CommonRail injectors manufactured by Bosch, Denso, Delphi, Siemens VDO at the stand.

The measurement takes place in an 8-channel beakerless FLAGMAN-FLOW system. The complex consists of a FLAGMAN-FLOW measuring unit and a CR-TESTER controller. CRT-5040. The complex is also equipped with a vacuum system for coding Deiphi C2i, C3i injectors. Computer control of the set through the CASCADE software.



DL-CR50015

Sensor for coding

Scope of delivery FLAGMAN-CODE

Measurement unit without beaker FLAGMAN-FLOW	1 pc
Controller CR-TESTER. CRT-5040	1 pc
Vacuum system	1 set
Software	1 pc
Passport (technical description, instruction manual)	1 pc
Set of connecting cables for FLAGMAN-FLOW measuring unit and CR-TESTER controller. CRT-5040	1 set
Extension cord for injector cables: "Injector" socket -1.5m	1 pc
Adapter cable for injectors	1 set
Adapter cable for high pressure regulators	1 pc
Adapter cable for low pressure regulators	1 pc
Adapter cable for pressure sensor	1 pc
Power cable 220 V	1 pc
Connectors for self-manufacturing of cables into sockets: "Protection", "TanktC", "RegtC", "Cycle", "Pump", "Invertor", "Rpm"	1 set
Temperature sensor for monitoring the temperature of the liquid in the tank: "TanktC" socket	1 pc
Temperature sensors for measuring the temperature of the TJ backflow	4 pcs
Reed switch for connecting a protective screen: "Protection" socket	1 pc
Fuse 3A	1 pc
Connecting pipelines	1 set
DL-CR50015 Injection start measuring sensor (for coding)	1 pc



FLAGMAN-CODE-L

CR injector test kit

The FLAGMAN-FULL complex is intended for testing common rail injectors manufactured by Bosch, Denso, Delphi, Siemens VDO at the stand.

The measurement takes place in an 8-channel beakerless FLAGMAN-FLOW system. The complex consists of a FLAGMAN-FLOW measuring unit and a CR-TESTER controller. CRT-5040. The complex is also equipped with a vacuum system for coding Deiphi C2i, C3i injectors. Computer control of the set through the CASCADE software.

Kit of delivery FLAGMAN-CODE-L



DL-CR50015

Sensor for coding

Measurement unit without beaker FLAGMAN-FLOW		1 pc
Controller CR-TESTER. CRT-5040		1 pc
Vacuum system		1 set
Software		1 pc
Passport (technical description, instruction manual)		1 pc
Set of connecting cables for FLAGMAN-FLOW measuring unit and CR-TESTER controller. CRT-5040		1 set
Extension cord for injector cables: "Injector" socket -1.5m		1 pc
Adapter cable for injectors		1 set
Adapter cable for high pressure regulators		1 pc
Adapter cable for low pressure regulators		1 pc
Adapter cable for pressure sensor		1 pc
Power cable 220 V		1 pc
Connectors for self-manufacturing of cables into sockets: "Protection", "TanktC", "RegtC", "Cycle", "Pump", "Invertor", "Rpm"		1 set
Temperature sensor for monitoring the temperature of the liquid in the tank: "TanktC" socket		1 pc
Temperature sensors for measuring the temperature of the TJ backflow		4 pcs
Reed switch for connecting a protective screen: "Protection" socket		1 pc
Fuse 3A		1 pc
Connecting pipelines		1 set
DL-CR50015	Injection start measuring sensor (for coding)	1 pc
DL-CR10015	Nozzle holder frame	1 pc
DL-CR10025	Injector holder bracket assembly	1 pc
DL-CR10006	Protective glass (6mm) or DL-CR10010 Protective glass (10mm)	1 pc

CRISTINA

The **CRistina** complex is designed for assembling injectors of the COMMON RAIL BOSCH, DELPHI, DENSO systems using a technology that allows you to calculate and select all the necessary adjusting elements.

The software and hardware of the complex allows not only to accurately measure the required dimensions, but also to diagnose the state of the injector electromagnet with the measurement of the resistance and inductance of the winding.

The working program of the complex contains a detailed database of mounting dimensions of the most common COMMON RAIL injectors and a complete visualization of the assembly process, which allows you to avoid assembly errors and significantly reduce repair time.

To eliminate errors in measuring dimensions, the design of the CRistina complex allows you to accurately and rigidly base the nozzle body to eliminate the effects of vibration and uncontrolled movement of the measured element relative to the measuring device.

Equipment options:

- CRISTINA-BASE
- CRISTINA-BASE-F
- CRISTINA-FULL
- CRISTINA-PROF
- CRISTINA-PROF-FULL
- CRISTINA-SPECIAL





DL-UNI20150 CRISTINA - PIEZO

The device is designed to test piezo injectors and piezo package.

The device confidently determines all the faults of the piezo package. Identifies problems that similar instruments or stands do not detect.

The device was developed for the assembly of Siemens injectors, but it is also efficient with BOSCH injectors.

Device capabilities:

1. Signal giving to activate the nozzle on the hand press
2. Measurement of the resistance of the piezo package
3. Breakdown test on the case
4. Measuring the capacity of the piezo package
5. Measurement of the smooth running of the piezo package

Contents of delivery:

1. Signal generator "CRistina-PIEZO"
2. A set of cables to the signal generator "CRistina-PIEZO"
 - Power cable 220V
 - Main cable for connecting to the piezo package
 - Cable adapter universal
 - Adapter cable with crocodile clips
 - Earthing cable
3. Passport (technical description, operating instructions) 1 pc.

ATTENTION ! ADDITIONAL EQUIPMENT ARE POSSIBLE TOGETHER WITH THE DEVICE!



 acoustic testing

**DL-UNI20150A CRISTINA - PIEZO
ACOUSTIC**

The device is designed to test piezo injectors and piezo package.

The device confidently determines all the faults of the piezo package. Identifies problems that similar instruments or stands do not detect.

The device was developed for the assembly of Siemens injectors, but it is also efficient with BOSCH injectors.

Device capabilities:

1. Signal giving to activate the nozzle on the hand press
2. Measurement of the resistance of the piezo package
3. Breakdown test on the case
4. Measuring the capacity of the piezo package
5. Measurement of the smooth running of the piezo package
6. Valve opening/closing control with acoustic test
7. Precise detection of valve opening and closing with an acoustic test

Contents of delivery:

1. Signal generator "CRistina-PIEZO"
2. A set of cables to the signal generator "CRistina-PIEZO"
 - Power cable 220V
 - Main cable for connecting to the piezo package
 - Cable adapter universal
 - Adapter cable with crocodile clips
 - Earthing cable
3. Microphone
4. Microphone holder
5. Passport (technical description, operating instructions) 1 pc.

ATTENTION ! ADDITIONAL EQUIPMENT ARE POSSIBLE TOGETHER WITH THE DEVICE!



DL-UNI20050 CRISTINA - PIEZO

The device is designed to test piezo injectors and piezo package.

The device confidently determines all the faults of the piezo package. Identifies problems that similar instruments or stands do not detect.

The device was developed for the assembly of Siemens injectors, but it is also efficient with BOSCH injectors.

**DL-CR50157****Device capabilities:**

1. Signal giving to activate the nozzle on the hand press
2. Measurement of the resistance of the piezo package
3. Breakdown test on the case
4. Measuring the capacity of the piezo package
5. Measurement of the smooth running of the piezo package

Contents of delivery:

1. Controller CRistina-Piezo
2. The clamp-holder of injectors Piezo ST-04
3. Bracket holder.
4. The air meter.
5. The air filter.
6. The distributive air valve.
7. Reducer for air.
8. The electronic manometer.
9. Set of tubes.
10. Quick coupling 6mm.
11. Set of 2 nozzles for the backflow of the Siemens VDO injectors
12. **DL-CR50157** Set of adapters for measuring of the valve stroke of CR VDO Siemens injector (DL-CR50165 for DL-UNI20050-F)
13. Connector M12x1,5X1/8"

ATTENTION ! ADDITIONAL EQUIPMENT ARE POSSIBLE TOGETHER WITH THE DEVICE!

It differs from the DL-UNI20050F set in a less complete set of adapters for injectors.

DL-UNI20050F CRISTINA - PIEZO

The device is designed to test piezo injectors and piezo package.

The device confidently determines all the faults of the piezo package. Identifies problems that similar instruments or stands do not detect. The device was developed for the assembly of Siemens injectors, but it is also efficient with BOSCH injectors.

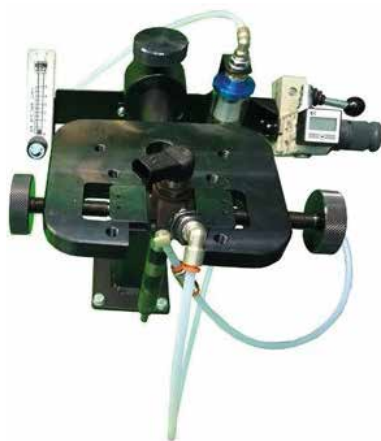
**DL-CR50165****Device capabilities:**

1. Signal giving to activate the nozzle on the hand press
2. Measurement of the resistance of the piezo package
3. Breakdown test on the case
4. Measuring the capacity of the piezo package
5. Measurement of the smooth running of the piezo package

Contents of delivery:

1. Controller CRistina-Piezo
2. Clamp-holder for injectors Piezo ST-04
3. Bracket holder for equipment.
4. Air meter.
5. Air filter.
6. Air distribution crane.
7. Reducer for air.
8. Electronic manometer.
9. Set of tubes.
10. Coupling of quick connection 6mm.
11. Set of 2 fittings for backflow of Siemens VDO injectors
12. **DL-CR50165** Set of adapters for measuring the stroke of the injector valve CR VDO Siemens
13. Adapter M12x1.5X 1/8 "

ATTENTION ! ADDITIONAL EQUIPMENT ARE POSSIBLE TOGETHER WITH THE DEVICE!

It differs from the DL-UNI20050 kit in a more complete set of adapters for injectors.

 acoustic testing

**DL-UNI20050A CRISTINA - PIEZO
ACOUSTIC**

The device is designed to test piezo injectors and piezo package.

The device confidently determines all the faults of the piezo package. Identifies problems that similar instruments or stands do not detect. The device was developed for the assembly of Siemens injectors, but it is also efficient with BOSCH injectors.

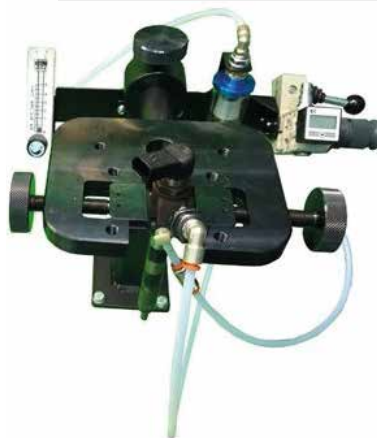
DL-CR50157
Device capabilities:

1. Signal giving to activate the nozzle on the hand press
2. Measurement of the resistance of the piezo package
3. Breakdown test on the case
4. Measuring the capacity of the piezo package
5. Measurement of the smooth running of the piezo package
6. Valve opening / closing control with acoustic test

Contents of delivery:

1. Controller CRistina-Piezo
2. Clamp-holder for injectors Piezo ST-04
3. Bracket holder for equipment.
4. Air meter.
5. Air filter.
6. Air distribution crane.
7. Reducer for air.
8. Electronic manometer.
9. Set of tubes.
10. Coupling of quick connection 6mm.
11. Set of 2 fittings for backflow of Siemens VDO injectors
12. **DL-CR50157** Set of adapters for measuring the stroke of the valve injector CR VDO Siemens
13. Adapter M12x1.5X 1/8 "
14. Microphone
15. Microphone holder
16. Passport

ATTENTION ! ADDITIONAL EQUIPMENT ARE POSSIBLE TOGETHER WITH THE DEVICE!

*It differs from the **DL-UNI20050F (A)** kit in a less complete set of adapters for injectors.*

 acoustic testing

**DL-UNI20050FA CRISTINA - PIEZO
ACOUSTIC**

The device is designed to test piezo injectors and piezo package.

The device confidently determines all the faults of the piezo package. Identifies problems that similar instruments or stands do not detect.

The device was developed for the assembly of Siemens injectors, but it is also efficient with BOSCH injectors.

DL-CR50165
Device capabilities:

1. Signal giving to activate the nozzle on the hand press
2. Measurement of the resistance of the piezo package
3. Breakdown test on the case
4. Measuring the capacity of the piezo package
5. Measurement of the smooth running of the piezo package
6. Valve opening / closing control with acoustic test

Contents of delivery:

1. Controller CRistina-Piezo
2. Clamp-holder for injectors Piezo ST-04
3. Bracket holder for equipment.
4. Air meter.
5. Air filter.
6. Air distribution crane.
7. Reducer for air.
8. Electronic manometer.
9. Set of tubes.
10. Coupling of quick connection 6mm.
11. Set of 2 fittings for backflow of Siemens VDO injectors
12. **DL-CR50165** Set of adapters for measuring the stroke of the injector valve CR VDO Siemens
13. Adapter M12x1.5X 1/8 "
14. Microphone
15. Microphone holder
16. Passport

ATTENTION ! ADDITIONAL EQUIPMENT ARE POSSIBLE TOGETHER WITH THE DEVICE!

Differs from DL-UNI20050 (A) kit in more complete set of injector adapters

DL-UNI20051 Комплект с CRistina-PIEZO

Repair kit for piezo injectors CR Siemens / VDO (without clamp for clamping injectors and acoustic test). The device confidently detects all malfunctions of the piezoelectric package. Identifies problems that similar instruments or benches do not detect.

The device was developed for assembling Siemens injectors, but it is also functional with Bosch injectors.

**Device capabilities:**

1. Signal giving to activate the nozzle on the hand press
2. Measurement of the resistance of the piezo package
3. Breakdown test on the case
4. Measuring the capacity of the piezo package
5. Measurement of the smooth running of the piezo package

Contents of delivery:

1. Controller CRistina-Piezo
 2. Bracket holder for equipment.
 3. Air meter.
 4. Air filter.
 5. Air distribution crane.
 6. Reducer for air.
 7. Electronic manometer.
 8. Set of tubes.
 9. Quick coupling 6mm.
 10. Set of 2 fittings for backflow of Siemens VDO injectors
 11. Adapter M12x1.5X 1/8 "
- DL-UNI20051A CRistina-PIEZO kit with acoustic test
Repair kit for piezo injectors CR Siemens / VDO (without clamp for clamping injectors)

ATTENTION ! ADDITIONAL EQUIPMENT ARE POSSIBLE TOGETHER WITH THE DEVICE!

 acoustic testing

DL-UNI20051A Комплект с CRistina-PIEZO

Repair kit for piezo injectors CR Siemens / VDO (without clamp for clamping injectors with acoustic test). The device is designed to test the piezo injector of the piezo package. The device confidently detects all malfunctions of the piezoelectric package. Identifies problems that similar instruments or benches do not detect.

The device was developed for assembling Siemens injectors, but it is also functional with Bosch injectors.

**Device capabilities:**

1. Signal giving to activate the nozzle on the hand press
2. Measurement of the resistance of the piezo package
3. Breakdown test on the case
4. Measuring the capacity of the piezo package
5. Measurement of the smooth running of the piezo package
6. Valve opening / closing control with acoustic test

Contents of delivery:

1. Controller CRistina-Piezo
2. Bracket holder for equipment.
3. Air meter.
4. Air filter.
5. Air distribution crane.
6. Reducer for air.
7. Electronic manometer.
8. Set of tubes.
9. Quick coupling 6mm.
10. Set of 2 fittings for backflow of Siemens VDO injectors
11. Adapter M12x1.5X 1/8 "
12. Microphone
13. Microphone holder
14. Passport

ATTENTION ! ADDITIONAL EQUIPMENT ARE POSSIBLE TOGETHER WITH THE DEVICE!

ADDITIONAL EQUIPMENT FOR CRISTINA-PIEZO

**DL-UNI20054 ACOUSTIC BOARD****Acoustic test kit for CRISTINA - PIEZO****The kit includes:**

1. Microphone in a plastic case
2. Clip for fixing the microphone on the nozzle body
3. Acoustic test board for installation inside the instrument CRISTINA -PIEZO
4. Set of connecting wires
5. Set of racks and bolts for fixing the board
6. Instructions for assembly.

ADDITIONAL EQUIPMENT FOR CRISTINA-PIEZO

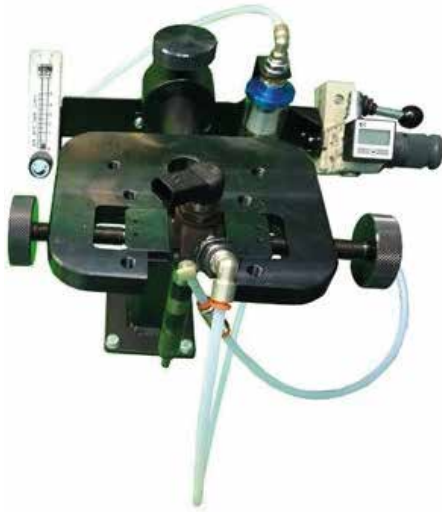
**Contents of delivery:**

1. Clamp-holder of nozzles PiezoST-04
2. Equipment holder bracket.
3. Air meter.
4. Air filter.
5. Air distribution valve.
6. Reducer for air.
7. Electronic pressure gauge.
8. Set of tubes.
9. 6mm quick coupling.
10. Set of 2 fittings (DL-60151/61 and DL-60151/66) for backflow of Siemens injectors
11. Adapter M12x1.5X 1/8"

DL-UNI20052**Injector repair kit****CR Siemens VDO (without CRistina-Piezo controller)****Kit features:**

1. Reliable installation and fixation of nozzles
2. Air supply with pressure valve
3. Adjusting the air pressure with a reducer
4. Air filtration from liquid residues in the nozzle
5. Convenient connection with fittings made of delivery set to injector return
6. Valve opening/closing control with using a rotameter

**Contents of delivery:**

1. Equipment holder bracket.
2. Air meter.
3. Air filter.
4. Air distribution valve.
5. Reducer for air.
6. Electronic pressure gauge.
7. Set of tubes.
8. 6mm quick coupling.
9. A set of 2 fittings (DL-60151/61 and DL-60151/66) for backflow of Siemens injectors
10. Adapter M12x1.5X 1/8"

DL-UNI20053**Injector repair kit****CR Siemens VDO (without CRistina-Piezo controller
and clamps ST04)****Kit features:**

1. Air supply with push valve
2. Adjustment of air pressure by a reducer
3. Air filtration from liquid residues in the nozzle
4. Convenient connection with fittings from the kit supplies to the return nozzle
5. Valve opening/closing control with rotameter

ADDITIONAL EQUIPMENT FOR CRISTINA-PIEZO

**DL-CR50165**

**Set of adapters with indicator head
for measuring the stroke of the CR VDO injector valve
Siemens all types**

Contents of delivery:

1. **DL-CR31079** Adapter for measuring the parameters of the piezo injector package of a new type M25x1
2. **DL-CR31179** Adapter for measuring the parameters of the piezo injectors of the old type M27x1
3. **DL-CR31080** Adapter housing for measuring the stroke of the injector valve
4. **DL-CR31081** Nut to the body of the adapter for measuring the stroke of the injector valve of the new type M25x1
5. **DL-CR31178** Nut to the body of the adapter for measuring the stroke of the injector valve of the new type M27x1
6. **D-7153136** Hex key 2mm
7. **DL-KIP002** Indicator measuring head mechanical 0.001mm stroke 5mm
8. **DL-CR31177** Measuring probe
9. Organizer

**DL-CR50157**

**Set of adapters with indicator head for
measuring the parameters of the CR VDO Siemens injector.**

Contents of delivery:

1. **DL-CR31079** Adapter for testing the piezo package.
2. **DL-CR50147** Adapter (body with nut) for measuring valve travel.
3. **DL-KIP002** Indicator measuring mechanical head with an accuracy of 0.001 mm, stroke 5 mm
4. **D-7153136** Hex key 2mm
5. **DL-CR31177** Measuring probe
6. Organizer

**DL-CR30545**

**Wrench for mounting / dismantling the multiplier nut
SIEMENS injectors**

**DL-CR50163**

Wrench 25mm for mounting/dismantling the piezo package of CR VDO Siemens injectors.
Landing dimensions of the key: a) hexagon for piezo package 25mm
b) 1/2" square for torque wrench

**DL-CR50164**

Wrench 27mm for mounting/dismantling the piezo package of CR VDO Siemens injectors.
Landing dimensions of the key: a) hexagon for piezo package 27mm
b) 1/2" square for torque wrench

CR-ACTIVE

The **CR-Active** signal activator is designed to supply a control signal to the solenoid valve of Common-Rail injectors. It is used to measure the valve stroke when measuring the magnetic gap of electromagnetic Common-Rail injectors.

**The base package includes:**

- Signal generator "CR-ACTIVE" - 1 pc.
- Power cable (2.1) 220V – 1 pc.
- Main cable (2.2) for connection to the electromagnet – 1 pc.
- Adapter cable (2.3) for light injector – 1 pc.
- Adapter cable (2.4) for cargo injector – 1 pc.
- Passport (technical description, operating instructions) - 1 pc.

CR-ACTIVE**EQUIPMENT AND CHARACTERISTICS****The complete package includes:**

- Signal generator "CR-ACTIVE" - 1 pc.
- Power cable (2.1) 220V – 1 pc.
- Main cable (2.2) for connection to the electromagnet – 1 pc.
- Adapter cable (2.3) for light injector – 1 pc.
- Adapter cable (2.4) for cargo injector – 1 pc.
- Stand for injectors – 1 pc.
- Set of measuring probes. - 1 set
- Set of 4 adapters for measuring force parameters. - 1 PC.
- Measuring indicator head – 1 pc.
- Passport (technical description, operating instructions) - 1 pc.

Main technical data and characteristics:

Supply voltage	~220 V ±15%
Power consumption	up to 150 W
Four levels of current control signal	
Control signal duration	1.5 sec
Number of operations per minute	no more than 12
Short circuit protection	
Activator dimensions (depth x width x height) mm	240x230x72
Device weight	net 4kg
Weight of the complete set	net 9kg

CR-NeXT

CR-NeXT – Armature activator device for Common-Rail injector solenoid valve

The CR-NeXT device is designed to supply a control signal to the solenoid valve of Common-Rail injectors. It is mainly used to measure the valve stroke when measuring the magnetic gap of common-rail solenoid injectors.



Contents of delivery:

- CR-NeXT device – 1 pc.
- Power cable 220 V – 1 pc.
- Universal cable for connection to the injector – 1 pc.
- Extension cable – 1 pc
- Cable with crocodile clips – 1 pc.



DL-RLC41R

Instrument for measuring capacitance of piezo packs nozzles.

Contents of delivery:

- LRC Meter 41R
- Set of test leads
- Communication cable
- Software CD
- Battery



PUMP TEST.02

Common-Rail High Pressure Pump Testing Equipment



The kit includes:

1. The **PTC-2520** device is designed to provide user-programmable control signals to Common Rail injection pump pressure regulators to test their performance.
2. Device **FMDE-520**, designed to measure the performance of the Common Rail injection pump in two channels.
3. Tool rack on wheels for easy operation.
4. A set of adapter cables.
5. Liquid fine filters (2 pcs.)
6. Software.





PTC-2520 CP TESTER

Device for testing and testing high-pressure fuel pumps of the Common Rail system with a set of cables.



FMDE-520

Device for testing the performance of fuel pumps of the Common Rail system of various manufacturers: Bosch, Delphi, Denso, Siemens, Cummins on a test bench.

It is a 2-channel liquid flow meter (pump supply and return discharge) in various modes, with digital information output to a backlit liquid crystal display.



UIS-TESTER 2

The **UIS TESTER Multi-CAM** device is designed to test and verify the performance of unit injectors (UIS - Unit Injector System) and individual high pressure fuel pumps with high pressure solenoid valves (UPS - Unit Pump System).

Using the **UIS TESTER Multi-CAM** device, you can measure the response time of an electric valve, the device also has the ability to automatically control the electric drive of the measuring unit, and additional options for self-updating the firmware and adapting to various CAMBOX versions.

The UIS TESTER Multi-CAM device allows you to:

- Set high pressure solenoid valve control signal;
- Measure the rotational speed of the pressure cam drive shaft;
- Set the required number of cycles;
- Preset mode, for 5 solenoid valve control modes;
- Set any value of the solenoid valve actuation advance angle.



Contents of delivery:

- Instrument UIS TESTER Multi-CAM;
- Software with BOSCH test plans;
- Speed sensor; power cable;
- Adapter cable for connecting the speed sensor;
- Adapter cable for connecting BOSCH injectors 1 type;
- Cable-adapter for connecting injectors BOSCH 2type;
- Adapter cable for connecting DELPHI injectors;
- Universal adapter cable for injectors;
- Limit switch (reed switch) for protective fencing at the stand;
- Connector for curtain control cable.



DL-UNI20001 PR-INDICATOR

Electronic pressure gauge for hand press (instead of regular).
Thread for the sensor in the indicator leg M12x1.5.

Contents of delivery:

- Electronic pressure gauge with cable for 1500 bar pressure sensor – 1 pc.
 - Charger for manometer accumulator – 1 pc.
- NB! The pressure sensor is not included in the scope of delivery.



DL-UNI20002 PR-INDICATOR

Electronic pressure gauge with pressure sensor for 1500 bar for a hand press (instead of the regular one).

Contents of delivery:

- Electronic pressure gauge with cable for 1500 bar pressure sensor – 1 pc.
- Charger for manometer accumulator – 1 piece,
- Pressure sensor for 1500 bar - 1 pc.



DL-RP410 (without pressure sensor)

DL-RP415 (with pressure sensor. 1500 bar)

Hand press RP 400 for injector testing with electronic pressure gauge

Contents of delivery:

- mechanical press - 1 pc.
- connecting tube – 2 pcs.
- electronic pressure gauge with cable - 1 pc.
- battery charger - 1 pc.
- pressure sensor (for **RP 415**) for 1500 bar – 1 pc.



DL-RP510 (without pressure sensor)

DL-RP515 (with pressure sensor. 1500 bar)

ZECA hand press for injector testing with electronic pressure gauge

Contents of delivery:

- mechanical press - 1 pc.
- connecting tube – 2 pcs.
- electronic pressure gauge with cable - 1 pc.
- battery charger - 1 pc.
- pressure sensor (for **RP 515**) for 1500 bar – 1 pc.



DL-UNI20065

PR-TESTER.V05

Electronic pressure gauge complete with charger device. Electronic pressure gauge included with charger



DL-UNI20077

adapter cable for pressure sensor BOSCH 1500 bar



DL-UNI21030

mounting bracket electronic manometer



DL-UNI30237

Pressure gauge leg (fitting) G1/2 with nut M12 x 1.25 mm

DL-UNI30445

Manometer leg (fitting) M20 x 1.5mm with nut M12 x 1.25 mm



DL-CR10058

DL-CR10059

DL-CR10060

Pressure sensor 1500 bar

DL-UNI20065 PR-TESTER.V05

Electronic pressure gauge suitable for hand presses:



DL-RP420

(without pressure sensor)

DL-RP425

(with pressure sensor. 1500 bar)

Hand press RP 400 for injector testing with electronic pressure gauge DL-UNI20065

Contents of delivery:

- mechanical press - 1 pc.
- connecting tube – 2 pcs.
- electronic pressure gauge with cable - 1 pc.
- battery charger - 1 pc.
- pressure sensor (for **RP 425**) for 1500 bar – 1 pc.



DL-RP520

(without pressure sensor)

DL-RP525

(with pressure sensor. 1500 bar)

ZECA hand press for injector testing with electronic pressure gauge DL-UNI20065

Contents of delivery:

- mechanical press - 1 pc.
- connecting tube – 2 pcs.
- electronic pressure gauge with cable - 1 pc.
- battery charger - 1 pc.
- pressure sensor (for **RP 525**) for 1500 bar – 1 pc.

**PR-TESTER.V05**Electronic pressure gauge
2 channel**DL-UNI20061****Delivery set for measurement
pressure on 2 CHANNELS:**

1. **DL-UNI20065** Electronic pressure gauge
2. **DL-UNI20071** Main adapter cable for 2-channel connection - 1 pc.
3. **DL-UNI20072** Adapter cable for pressure sensor BOSCH type 1 – 2 pcs.
4. **DL-UNI20073** Adapter cable for pressure sensor BOSCH 2 type – 2 pcs.
5. **DL-UNI20074** DELPHI pressure sensor adapter cable – 2 pcs.
6. **DL-UNI20075** Adapter cable for universal for pressure sensor - 2 pcs.
7. Charger
8. The passport

PR-TESTER.V05Electronic pressure gauge
2 channel**DL-UNI20060****Delivery set for measurement
pressure on 1 CHANNEL:**

1. **DL-UNI20065** Electronic pressure gauge
2. **DL-UNI20070** Main adapter cable for single-channel connection – 1 pc.
3. **DL-UNI20072** Adapter cable for pressure sensor BOSCH type 1 – 1 pc.
4. **DL-UNI20073** BOSCH pressure sensor adapter cable 2 type – 1 pc.
5. **DL-UNI20074** DELPHI pressure sensor adapter cable – 1 pc.
6. **DL-UNI20075** Universal adapter cable for pressure sensor - 1 pc.
7. Charger
8. The passport



PR-TESTER.V03

Instrument for measuring fuel pressure in CR systems, FSI and measurement of air pressure and vacuum in pneumatic systems.

Contents of delivery:

- Pressure measuring device - 1 pc.
- **DL-UNI20072** Sensor adapter cable pressure BOSCH 1 type - 1 pc.
- **DL-UNI20075** Universal adapter cable for pressure sensor - 1 pc.
- Charger
- Passport / instruction manual / warranty card

Additional adapter cables

(not included in the main set):

DL-UNI20073 Adapter cable for pressure sensor BOSCH 2 type

DL-UNI20074 Adapter cable for pressure sensor DELPHI



DT-SCOPE

Oscilloscope attachment for measurement of the pressure value in the CommonRail system

**DL-UNI20009**

CR test kit

Contents of delivery:

DL-UNI30744	Tee – 1pc
DL-CR10050	Pressure sensor 1800 bar – 1 pc or DL-CR10061 , DL-CR10065
DL-TVD31414	HP tube 14x14x300 – 1 pc
DL-TVD31214	HP tube 12x14x300 – 1 pc
DL-UNI30218	Fittings 14x14 – 2 pcs
DL-UNI31498	Fitting 12x14 – 1 pc
DL-UNI30529	Plug M14x1,5 – 1 pc
DL-UNI30636	Plug M12x1,5 – 1 pc

**DL-CR50310KIT**

Adapter assembly for diagnostics of the fuel system

Contents of delivery:

DL-CR31557	Adapter housing - 1 pc.
DL-CR10056	Safety valve 1800 bar - 1 pc
DL-CR10050	Pressure sensor 1800 bar - 1 pc
DL-UNI30218	High pressure fitting M14(1,5)xM14(1,5) in a set with a washer - gasket DL-SHP15084 – 1 pc.
34-RL3106M5	L-shaped "fast" adapter - 1 pc
DL-P1002	PVC tube with a diameter of 4 mm - 30 cm



**DL-UNI20006**

CR test kit

Contents of delivery:

DL-UNI20005	PR-tester (electronic pressure gauge) - 1 pc.
DL-CR10050	Pressure sensor 1800 bar - 1 pc. or DL-CR10061, DL-CR10065
DL-UNI30744	Tee (for connecting a pressure sensor and HP tubes) - 1 pc
DL-UNI30218	Fittings 14x14 – 2 pcs
DL-UNI31498	Fitting 12x14 – 1 pc
DL-TVD31414	HP tube 14x14x300 – 1pc
DL-TVD31214	HP tube 12x14x300 – 1 pc
DL-UNI30529	Plug M14x1,5 – 1 pc
DL-UNI30636	Plug M12x1,5 – 1 pc

**DL-UNI20007**

CR test kit

Contents of delivery:

DL-UNI20005	PR-tester (electronic manometer) – 1pc		
DL-CR10050	Pressure sensor 1800 bar – 1 pc or DL-CR10061, DL-CR10065		
DL-UNI30744	Tee (for connecting the pressure sensor and HP tube) – 1pc		
DL-UNI30218	Fittings 14x14 – 2 pcs	DL-UNI31498	Fitting 12x14 – 1 шт.
DL-TVD31414	HP tube 14x14x300 – 1 pc	DL-TVD31214	HP tube 12x14x300 – 1 pc
DL-UNI30529	Plug M14x1,5 – 1 pc	DL-UNI30636	Plug M12x1,5 – 1 pc
DL-12CRM	Backflow test flask set (only for DL-UNI20007)		
DL-24CRM	Backflow test adapter kit (only for DL-UNI20007)		

**DL-UNI30287**

Adapter with internal thread G1/2" for pressure gauge at 2000 bar. Has a connection M14x1.5mm thread with 60° cone for tube high pressure (HPT)

Contents of delivery:
adapter - 1 pc.

**DL-UNI30508**

Adapter with internal thread M20x1.5mm for pressure gauge at 2500 bar. Has a connecting M14x1.5mm thread with 60° cone for tube high pressure (HPT).

Contents of delivery:
adapter - 1 pc.

**DL-SM**

Gasket for pressure gauge

**DL-CR14P2000**

Pressure gauge 2000 bar

**DL-CR14P2500**

Pressure gauge 2500 bar

**DL-CR50246**

Manometer mounting bracket.

Made in the form of a hook and gauge holder brackets. Used with pressure gauges of the series D-12-TV63

**DL-KM2000**

**Pressure gauge bracket for 2000bar.
For rail DL-CR30181 and DL-CR30522**

Contents of delivery:

- bracket
- clamping bar
- M6x60 bolt, nuts, washers - 2 sets
- M6x45 bolt, washers - 2 sets

**DL-KM3000**

**Pressure gauge bracket 2000bar
for installation on a stand plate.**

Contents of delivery:

- bracket
- Profile bolt with nut, washer and grommet
- clamping bar
- M6X60mm bolt with nut, washer and grommet – 2 sets

**DL-KM2500**

**Pressure gauge bracket for 2500bar.
For rail DL-CR30181 and DL-CR30522**

Contents of delivery:

- main bracket
- pressure gauge mounting ring
- M6x45 bolt, washers - 2 sets
- M6x30 bolt, washers - 2 sets
- M6x10mm bolt - 3 pcs.

**DL-KM3500**

**Pressure gauge bracket 2500bar
for installation on a stand plate**

Contents of delivery:

- main bracket
- pressure gauge mounting ring
- Profile bolt with nut, washer and grommet
- M6 x30mm bolt with washer and grommet – 2 sets
- M6x10mm bolt - 3 pcs.

Anti-vibration pressure gauges with glycerin D-12-TG63 and D-12TV63 series

**D-12-TG63-1-0**

Pressure gauge for vacuum from -1-0 bar Ø63
back 1/4" flange type

**D-12-TG63-1-3**

Vacuum pressure gauge from -1-3bar Ø63
back 1/4" flange type

**D-12-TG63-01**

Manometer for 0÷1 bar, Ø63
back 1/4" flange type

**D-12-TG63-02,5**

Manometer for 0÷2.5 bar, Ø63
back 1/4" flange type

**D-12-TG63-004**

Manometer for 0÷4 bar, Ø63
back 1/4" flange type

**D-12-TG63-006**

Manometer for 0÷6 bar, Ø63
back 1/4" flange type

**D-12-TG63-010**

Manometer for 0÷10 bar, Ø63
back 1/4" flange type

**D-12-TG63-016**

Manometer for 0÷16 bar, Ø63
back 1/4" flange type

**D-12-TG63-025**

Manometer for 0÷25 bar, Ø63
back 1/4" flange type

**D-12-TG63-040**

Manometer for 0÷40 bar, Ø63
back 1/4" flange type

**D-12-TG63-060**

Manometer for 0÷60 bar, Ø63
back 1/4" flange type

Anti-vibration pressure gauges with glycerin D-12-TG63 and D-12TV63 series

**D-12-TV63-1-0**

Vacuum gauge from $-1-0$ bar $\varnothing 63$
with fitting from below 1/4"

**D-12-TV63-1-3**

Vacuum pressure gauge from $-1-3$ bar $\varnothing 63$
with fitting from below 1/4"

**D-12-TV63-01**

Manometer for $0+1$ bar, $\varnothing 63$
with fitting from below 1/4"

**D-12-TV63-02,5**

Manometer for $0+2.5$ bar, $\varnothing 63$
with fitting from below 1/4"

**D-12-TV63-004**

Manometer for $0+4$ bar, $\varnothing 63$
with fitting from below 1/4"

**D-12-TV63-006**

Manometer for $0+6$ bar, $\varnothing 63$
with fitting from below 1/4"

**D-12-TV63-010**

Manometer for $0+10$ bar, $\varnothing 63$
with fitting from below 1/4"

D-12-TV63-016

Manometer for $0+16$ bar, $\varnothing 63$
with fitting from below 1/4"

D-12-TV63-025

Manometer for $0+25$ bar, $\varnothing 63$
with fitting from below 1/4"

D-12-TV63-040

Manometer for $0+40$ bar, $\varnothing 63$
with fitting from below 1/4"

D-12-TV63-060

Manometer for $0+60$ bar, $\varnothing 63$
with fitting from below 1/4"

Anti-vibration pressure gauges with glycerin of the D-12-TG100 and D-12TV100 series

**D-12-TG100-1-0**

Vacuum gauge, Ø100 mm
with connector at the back
-1 to 0 bar / -0.10 to 0 MPa

D-12-TG100-02,5

Pressure gauge, Ø100 mm with 1/2" rear connection
0 to 2.5 bar / 0 to 0.25 MPa

D-12-TG100-004

Pressure gauge, Ø100 mm with 1/2" rear connection
0 to 4 bar / 0 to 0.4 MPa

D-12-TG100-016

Pressure gauge, Ø100 mm with 1/2" rear connection
0 to 16 bar / 0 to 1.6 MPa

D-12-TG100-040

Pressure gauge, Ø100 mm with 1/2" rear connection
0 to 40 bar / 0 to 4 MPa

**D-12-TV100-1-0**

Vacuum gauge, Ø100 mm
with bottom fitting 1/2"
-1 to 0 bar / -0.10 to 0 MPa

D-12-TV100-02,5

Pressure gauge, Ø100 mm with 1/2" bottom connection
0 to 2.5 bar / 0 to 0.25 MPa

D-12-TV100-004

Pressure gauge, Ø100 mm with 1/2" bottom connection
0 to 4 bar / 0 to 0.4 MPa

D-12-TV100-016

Pressure gauge, Ø100 mm with 1/2" bottom connection
0 to 16 bar / 0 to 1.6 MPa

D-12-TV100-040

Pressure gauge, Ø100 mm with 1/2" bottom connection
0 to 40 bar / 0 to 4 MPa

**DL-KIP0001****Mechanical dial gauge****Characteristics :**

- Type - mechanical
- Stroke - 10mm
- Resolution - 0.01 mm
- Repeatability - 0.01 mm

**DL-KIP0002****Mechanical dial gauge****Characteristics :**

- Type - mechanical
- Stroke - 5 mm
- Resolution - 0.001 mm
- Repeatability - 0.001 mm

**DL-KIP0003****Mechanical dial gauge****Characteristics :**

- Type - mechanical
- Stroke - 5 mm
- Resolution - 0.01 mm
- Repeatability - 0.02 mm

**DL-KIP0004****Mechanical dial gauge****Characteristics :**

- Type - mechanical
- Stroke - 10 mm
- Resolution - 0.01 mm
- Repeatability - 0.02 mm

**DL-KIP0005****Mechanical dial gauge****Characteristics :**

- Type - mechanical
- Stroke - 20 mm
- Resolution - 0.01 mm
- Repeatability - 0.03 mm

**DL-KIP0006****Mechanical dial gauge****Characteristics :**

- Type - mechanical
- Stroke - 30mm
- Resolution - 0.01 mm
- Repeatability - 0.03 mm

**DL-KIP0007****Mechanical dial gauge****Characteristics :**

- Type - mechanical
- Stroke - 50 mm
- Resolution - 0.01 mm
- Repeatability - 0.04 mm

**DL-KIP0008****Indicator measuring head****Characteristics :**

- Type - mechanical
- Stroke - 25 mm
- Resolution - 0.01 mm
- Repeatability - 0.02 mm

**DL-KIP0010****Indicator measuring head****Characteristics :**

- Type - electronic
- Stroke - 12.7mm
- Resolution - 0.01 mm
- Repeatability - 0.01 mm
- Sleeve - 8 mm
- Automatic shutdown

**DL-KIP0011****Indicator measuring head****Characteristics :**

- Type - electronic
- Stroke - 12.7mm
- Resolution - 0.001 mm
- Repeatability - 0.004 mm
- Sleeve - 8 mm
- Automatic shutdown

**DL-KIP0012****Indicator measuring head****Characteristics :**

- Type - electronic
- Stroke - 25 mm
- Resolution - 0.001 mm
- Repeatability - 0.004 mm
- Sleeve - 8 mm
- Automatic shutdown

**DL-KIP0015 Limit****Indicator measuring head****Characteristics :**

- Type - electronic
- Stroke - 12.5 mm
- Resolution - 0.01 mm
- Repeatability - 0.03 mm
- Sleeve - 8 mm
- Automatic shutdown

**DL-KIP0016 Limit****Indicator measuring head****Characteristics :**

- Type - electronic
- Stroke - 12.5 mm
- Resolution - 0.001 mm
- Repeatability - 0.004 mm
- Sleeve - 8 mm
- Automatic shutdown

**DL-KIP0019 TESA****Indicator measuring head****Characteristics :**

- Type - electronic
- Stroke - 12.7mm
- Resolution - 0.01 mm
- Repeatability - 0.01 mm
- Sleeve - 8 mm
- Automatic shutdown

**DL-KIP0020 TESA****Indicator measuring head****Characteristics :**

- Type - electronic
- Stroke - 12.7mm
- Resolution - 0.001 mm
- Repeatability - 0.002 mm
- Sleeve - 8 mm
- Automatic shutdown

**DL-KIP0021 TESA****Indicator measuring head****Characteristics :**

- Type - electronic
- Stroke - 25 mm
- Resolution - 0.001 mm
- Repeatability - 0.002 mm
- Sleeve - 8 mm
- Automatic shutdown

**DL-KIP0023 Dieselland****Measuring communication key
PC heads****DL-KIP0025 Eee****Indicator measuring head****Characteristics :**

- Type - electronic
- Stroke - 12.7mm
- Resolution - 0.001 mm
- Repeatability - 0.002 mm
- Sleeve - 8 mm
- Automatic shutdown

**DL-KIP0026 Eee****Indicator measuring head****Characteristics :**

- Type - electronic
- Stroke - 25 mm
- Resolution - 0.001 mm
- Repeatability - 0.004 mm
- Sleeve - 8 mm
- Automatic shutdown

**DL-KIP0028 Eee****Measuring communication key
PC heads**

**DL-KIP0029 SHAHE****Indicator measuring head****Characteristics :**

- Type - electronic
- Stroke - 12.7mm
- Resolution - 0.001 mm
- Repeatability - 0.002 mm
- Sleeve - 8 mm
- Automatic shutdown
- Communication with a PC using a COM port (cable included)

**DL-KIP030 SHAHE****Indicator measuring head****Characteristics :**

- Type - electronic
- Stroke - 12.7mm
- Resolution - 0.001 mm
- Repeatability - 0.002 mm
- Sleeve - 8 mm
- Automatic shutdown

**DL-KIP0031 SHAHE****Indicator measuring head****Characteristics :**

- Type - electronic
- Stroke - 25 mm
- Resolution - 0.001 mm
- Repeatability - 0.004 mm
- Sleeve - 8 mm
- Automatic shutdown

**DL-KIP0032 Eee****Indicator measuring head****Characteristics :**

- Type - electronic
- Stroke - 50 mm
- Resolution - 0.001 mm
- Repeatability - 0.005 mm
- Sleeve - 8 mm
- Automatic shutdown

**DL-KIP0034**

Indicator digital measuring head with an accuracy of 0.01 mm, stroke 12.5 mm

Characteristics :

- Type - electronic
- Resolution - 0.01mm
- Accuracy - 0.01mm
- Large, high contrast LCD display
- Carbide tip, thread - M2.5
- Sleeve - 8mm
- Automatic shutdown
- Case Ø – 60mm

**DL-KIP0035**

Indicator digital measuring head with an accuracy of 0.001 mm, stroke 12.5 mm

Characteristics :

- Type - electronic
- Measuring range - 12.7mm
- Resolution - 0.001mm
- Accuracy - 0.002mm
- Large, high contrast LCD display
- Carbide tip, thread - M2.5
- Sleeve - 8mm
- Automatic shutdown
- Case Ø – 60mm

**DL-KIP0036**

Indicator digital measuring head with an accuracy of 0.001 mm, stroke 25mm

Characteristics :

- Type - electronic
- Measuring range - 25.4mm
- Resolution - 0.001mm
- Accuracy - 0.004mm
- Large, high contrast LCD display
- Carbide tip, thread - M2.5
- Sleeve - 8mm
- Automatic shutdown
- Case Ø – 60mm

**DL-KIP0037**

Digital thickness gauge 0-12.7 mm, 0.001 mm

Characteristics :

- Measuring range - 0-12.7 mm
- Resolution - 0.001 mm
- LCD display
- Automatic shutdown
- Case Ø – 57 mm

**DL-KIP0250****Magnetic stand for mounting indicator measuring head**

The stand base has high magnetic properties, which allows installation both on horizontal as well as vertical surfaces.

ATTENTION!

The measuring head is not included in the scope of delivery!

**DL-KIP0251****Magnetic stand for mounting indicator measuring head**

The stand base has high magnetic properties, which allows installation both on horizontal as well as vertical surfaces.

ATTENTION!

The measuring head is not included in the scope of delivery!

**DL-00000**

Digital internal caliper
5-25mm / 0.005mm

Measuring range 5-25 mm
Measurement accuracy 0.005 mm

**DL-STC150**

digital caliper

**DL-M030**

(limited quantity)
Digital micrometer

Measuring range 0-25mm
Measurement accuracy 0.001mm

**DL-M035**

Digital micrometer

Measuring range 0-25mm
Measurement accuracy 0.001mm

**DL-M040**

D-SDM
tripod for digital
micrometer

**D-DMTS-KIT**

(limited quantity)
Kit DL-030 with DL-040.
Tripod and digital micrometer

**DL-UNI50062**

Measurement adapter compression in diesel engines (M12x1.5; stem L=175 mm).

Installed in place of the injector.

The pressure sensor is not included.

DL-UNI20008

Compression test kit in diesel engines.

Kit includes:

- adapter **DL-UNI50062** – 1 pc.
- Pr-tester - 1pc;
- cable for pressure sensor – 1 pc.

The pressure sensor is not included.

**Appearance and scope of delivery subject to change to improve equipment performance*

**DL-UNI20000**

Compression test kit in diesel engines.

Kit includes:

- adapter **DL-UNI50062** – 1 pc.
- Pr-tester - 1pc;
- cable for pressure sensor – 1 pc.
- pressure sensor up to 150 bar or 200 bar

**DL-CR10045**

Pressure sensor 150 bar for the compressor DL-UNI20008

**DL-CR10046**

Pressure sensor 250 bar for the compressor DL-UNI20008

**DL-PR363**

Compressor kit for diesel engines

The kit includes:

- Recording compressograph — 1 pc,
- Instruction — 1 pc,
- Quick — release adapter M14x1.5 - 1 pc,
- Adapter M14x1.5 — 1 pc,
- Adapter M12x1.5 — 1 pc,
- Spare cards — 1 k-t,
- Case — 1 pc.

**DL-WT04A3021**

Fuel pressure measuring kit in the low pressure line in diesel and gasoline engines.

Measuring range 0-140 psi (0-10 bar)



D-07147122

Torque wrench 1/2"
25-100 Nm



D-07147121

Torque wrench 3/8"



D-07147120

Torque wrench 1/4"
0-20 Nm



DL-UNI30776

Adapter with 1/4" internal square
and outer square 1/2"



DL-UNI31593

Adapter with vnutr. 3/8" square
and outer square 1/2"

**DL-RP400****Manual press for injector testing with mechanical pressure gauge****Contents of delivery:**

- mechanical press - 1 pc.
- mechanical pressure gauge - 1 pc.
- connecting tube – 2 pcs.

**DL-RP410** (without pressure sensor)**DL-RP415** (with pressure sensor. 1500 bar)**Manual press for injector testing with electronic pressure gauge****Contents of delivery:**

- mechanical press - 1 pc.
- connecting tube – 2 pcs.
- electronic pressure gauge with cable - 1 pc.
- battery charger - 1 pc.
- pressure sensor (for **RP 415**) for 1500 bar – 1 pc.

**DL-RP420** (without pressure sensor)**DL-RP425** (with pressure sensor. 1500 bar)**Manual press for injector testing with 2-channel electronic pressure gauge****Contents of delivery:**

- mechanical press - 1 pc.
- connecting tube – 2 pcs.
- electronic pressure gauge with cable - 1 pc.
- battery charger - 1 pc.
- pressure sensor (for **RP 425**) for 1500 bar – 1 pc.

**DL-RP430****Manufacturer - ZECA (Italy)
Flame test chamber (aspirator)
nozzle spray**

Allows for visual inspection performance of diesel injectors without harm to health. The device is going to work liquid for reuse.

**DL-RP500**

Manufacturer - ZECA (Italy)
Manual press for injector testing with mechanical pressure gauge

Contents of delivery:

- mechanical press - 1 pc.
- mechanical pressure gauge - 1 pc.
- connecting tube – 2 pcs.



DL-RP510 (without pressure sensor)

DL-RP515 (with pressure sensor. 1500 bar)

ZECA hand press for injector testing with electronic pressure gauge

Contents of delivery:

- mechanical press - 1 pc.
- connecting tube – 2 pcs.
- electronic pressure gauge with cable - 1 pc.
- battery charger - 1 pc.
- pressure sensor (for **RP 515**) for 1500 bar – 1 pc.



DL-RP520 (without pressure sensor)

DL-RP525 (with pressure sensor. 1500 bar)

ZECA hand press for injector testing with 2-channel electronic pressure gauge

Contents of delivery:

- mechanical press - 1 pc.
- connecting tube – 2 pcs.
- electronic pressure gauge with cable - 1 pc.
- battery charger - 1 pc.
- pressure sensor (for **RP 525**) for 1500 bar – 1 pc.

DL-CRN50113

Set of goniometers to control the tightening of the atomizer nut

Contents of delivery:**DL-CRN50107**

Protractor for injectors with nut diameter atomizer 17 mm

Angle range: 0° - 360°

**DL-CRN50110**

Protractor for injectors with diameter atomizer nuts 19 mm

Angle range: 0° - 360°

**DL-CRN50108**

Protractor for injectors with diameter atomizer nuts 21 mm

Angle range: 0° - 360°



All goniometers are for sale also separately.

**DL-UNF20113**

Liquid fine filter with 3 µm housing
for stands TRIUMF, CR-TEST, SPF, CR-JET, SPN(U), DORPAT

**DL-UNF20103**

3 micron liquid fine filter
for stands TRIUMF, CR-TEST, SPF, CR-JET, SPN(U), DORPAT

**DL-UNF20105**

5 micron liquid fine filter
for stands TRIUMF, CR-TEST, SPF, CR-JET, SPN(U), DORPAT

**DL-UNF20110**

10 micron liquid fine filter
for stands TRIUMF, CR-TEST, SPF, CR-JET, SPN(U), DORPAT

**DL-UNF20210**

Liquid fine filter (long body) 10 µm
for DORPAT stands

**DL-UNF20124**

3 micron liquid fine filter
for stands CRUIS, CR-JAS, CR-iXE

**DL-UNF24020**

Liquid filter
for stand TRIUMF, CRUIS, CR-JET (draining from the desktop)

**DL-UNI50214**

Filter housing with G3/4" connection thread
It has an inlet and outlet opening with G1/2" threads.
Suitable for **DL-UNF20113**, **DL-UNF20110**, **DL-UNF20103**,
DL-UNF20210

**DL-UNI50215**

Housing for filters with M16x1.5 mm connection thread.
It has inlet and outlet hole with G1/2" threads.
Suitable for **DL-UNF20124**.

**DL-UNI50338**

Housing for filters with connecting thread M16x1.5mm
and fitting 3/4" **DL-UNI30741**.
Fitting 16.5 x 16.5 **DL-UNI30520** can also be installed
The body has an inlet and outlet with M14 threads.

**DL-UNI50339**

Filter housing with connecting thread M16.5 x 16.5
DL-UNI30520
Fitting 16.5 x 3/4" **DL-UNI30741** can also be installed
The body has an inlet and outlet with M14 threads.

**DL-UNI31662**

Housing for filters with connecting thread M16x1.5mm.
Has inlet and outlet with M14 threads.

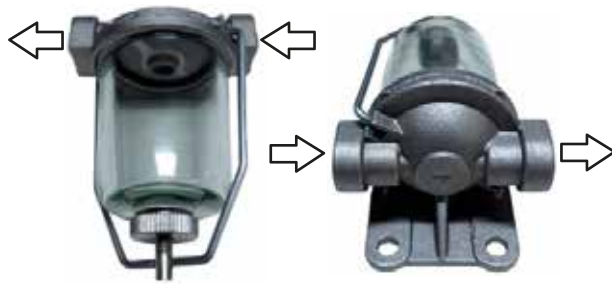

DL-UNF20300R

Filter - sump (entrance on the right)
The filter contains:

1. Holes for entry and exit M14x1.5mm
2. Mounting holes Ø 8mm

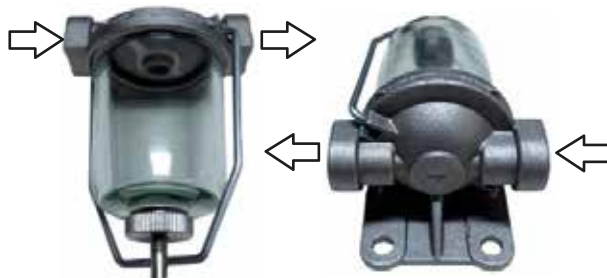

DL-UNF20300L

Filter - sump (entrance on the left)
The filter contains:

1. Holes for entry and exit M14x1.5mm
2. Mounting holes Ø 8mm



DL-CR30051

15 micron liquid filter
with 1/8" outlets



DL-UNI50126

15 micron liquid filter
with 3/8" outlets



DL-UNI50047

15 micron liquid filter
with fittings (herringbone) 10 mm

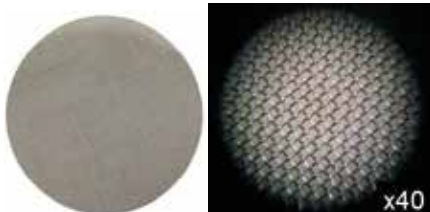

DL-SDF0410

Mesh 15 µm for filters
DL-UNI5026, DL-UNI50047, DL-CR30051

**DL-UNI30828**

Переходник с фильтром Bosch высокого давления для проверки насосов CP1, CP2, CP3, CP4.

Используется с накопителями давления (рейлом) DL-CR31083, DL-CR30181 и DL-CR30522.

Устанавливается в любое удобное место рейла.

В переходнике имеются резьбовые отверстия :

- для фильтра под специальный штуцер M18x1,5 (1 отв.)
- для подачи жидкости M14x1,5 (2 отв.сверху)
- для подсоединения датчика давления M18x1,5 (1 отв.)
- для подсоединения предохранительного клапана M20x1,5 (1 отв)
- для сброса давления в случае его превышения M5 (1 отв)



Комплект поставки:

1. переходник – 1 шт.
2. фильтр DL-UNF21100 высокого давления – 1 шт.
3. конусный штуцер для фильтра высокого давления M14xM18 – 1 шт.
4. штуцер M14x1,5 – 2 шт.
5. уплотнительная шайба – 3 шт.
6. заглушка M14x1,5 – 1 шт.
7. фитинг Ø 6мм xM5.

DL-CR50121

Переходник под фильтр высокого давления DL-UNF21100

Монтируется вместо обычного штуцера в накопитель давления (Rail) DL-CR30479, DL-CR30180, DL-CR30181, DL-CR30188, DL-CR30522, DL-CR30526.



Комплект поставки:

- переходник – 1 шт.,
корпус переходника с резьбой M14x1,5 – 1шт.

ВНИМАНИЕ!

Фильтр высокого давления DL-UNF21100 в комплект поставки не входит и заказывается отдельно!

DL-UNF21100

Фильтр высокого давления для накопителей давления (Rail)

DL-CR30479,DL-CR30180, DL-CR30181,DL-CR30188,
DL-CR30522,DL-CR30526

Применяется также с переходником DL-CR50121

**DL-SRS020****Calibration fluid SRS**

ISO 4113-CV-AW (VS 15665-OL-CV),
canister 20 liters.

Used in test benches for
testing of CR injectors, unit injectors
PLD sections.

**CRS Calibrol****Calibration fluid for diesel fuel
equipment**

The CRS Calibrol calibration fluid (20 litre plastic
canister container) is a test oil for testing injectors and
pumps of diesel fuel equipment.

CRS Calibrol is a low viscosity working oil for
calibration with a very tight viscosity tolerance.
It is distinguished by an exceptional level of protection
against wear and corrosion, as well as a low tendency
to foaming.

**DL-SRS200****Calibration fluid SRS**

ISO 4113-CV-AW (VS 15665-OL-CV),
Barrel 200 liters.

Used in test benches for
testing of CR injectors, unit injectors
PLD sections.

**DL-PLP125**

Plafond lighting for stands
TRIUMF / CRUIS / CR-Test / DORPAT / CR-Jet

Specifications:

Overall dimension	145x145 mm
Mounting hole size	125x125 mm
Power	9 W
Voltage	24 V

Supplied complete with power supply.

DL-PLP135

Plafond lighting for stands
TRIUMF / CRUIS / CR-Test / DORPAT / CR-Jet

Specifications:

Overall dimension	145x145 mm
Mounting hole size	135x135 mm
Power	9 W
Voltage	24 V

Supplied complete with power supply.

Fittings for connecting hydraulic and pneumatic systems

**34-RL3104M5**

Angle adapter M5 x Ø 4mm with collet

34-RL3106M5

Angle adapter M5 x Ø 6mm with collet

34-RL310401

Angle adapter 1/8" x Ø 4mm with collet

34-RL310601

Angle adapter 1/8" x Ø 6mm with collet

34-RL310801

Angle adapter 1/8" x Ø 8mm with collet

34-RL310602

Angle adapter 1/4" x Ø 6mm with collet

34-RL310802

Angle adapter 1/4" x Ø 8mm with collet

34-RL311002

Angle adapter 1/4" x Ø 10mm with collet

34-RL310803

Angle adapter 3/8" x Ø 8mm with collet

34-RL311003

Angle adapter 3/8" x Ø 10mm with collet

**34-RL020402**

Adapter with internal thread 1/4" x Ø 4mm with collet

34-RL020602

Adapter with internal thread 1/4" x Ø 6mm with collet

34-RL020401

Adapter with internal thread 1/8" x Ø 4mm with collet

34-RL020601

Adapter with internal thread 1/8" x Ø 6mm with collet

**34-RL0306**Adapter-coupling collet with M13x1mm thread
and 2 nuts Ø6 x Ø 6mm**34-RL0306C**Adapter-coupling collet with M14x1mm thread
and 2 nuts Ø6 x Ø 6mm**34-RL0306E**Adapter-coupling collet with M15x1mm thread
and 2 nuts Ø6 x Ø 6mm**34-RL0304C**Adapter-coupling collet with M10x1mm thread
and 2 nuts Ø4 x Ø 4mm**34-RL0308C**Adapter-coupling collet with M16x1mm thread
and 2 nuts Ø8 x Ø 8mm**34-RL0310C**Adapter-coupling collet with M18x1mm thread
and 2 nuts Ø10 x Ø 10mm

Fittings for connecting hydraulic and pneumatic systems

**34-RL01004M5**

Straight adapter M5 x Ø 4mm with collet

34-RL01006M5

Straight adapter M5 x Ø 6mm with collet

34-RL020401

Adapter straight 1/8" x Ø 4mm with collet

34-RL020601

Adapter straight 1/8" x Ø 6mm with collet

34-RL010801

Adapter straight 1/8" x Ø 8mm with collet

34-RL020602

Adapter straight 1/4" x Ø 6mm with collet

34-RL010802

Adapter straight 1/4" x Ø 8mm with collet

34-RL011002

Adapter straight 1/4" x Ø 10mm with collet

34-RL010803

Adapter straight 3/8" x Ø 8mm with collet

34-RL011003

Adapter straight 3/8" x Ø 10mm with collet

**34-RL0306B**

Adapter-coupling collet Ø 6 x Ø 6mm

34-RL0304B

Adapter-coupling collet Ø 4 x Ø 4mm

34-RL0308B

Adapter-coupling collet Ø 8 x Ø 8mm

34-RL0310B

Adapter-coupling collet Ø 10 x Ø 10mm

**34-RL0406**

Elbow fitting with collet clamp Ø 6mm

34-RL0408

Elbow fitting with collet clamp Ø 8mm

**34-RL0504**

Tee adapter Ø 4 x Ø 4 x Ø 4mm with collet

34-RL0506

Tee adapter Ø 6 x Ø 6 x Ø 6mm with collet

34-RL0508

Tee adapter Ø 8 x Ø 8 x Ø 8mm with collet

34-RL0510

Tee adapter Ø 10 x Ø 10 x Ø 10mm with collet

Fittings for connecting hydraulic and pneumatic systems

**DL-MOK**

Coupling adapter with check valve
Ø 6 x Ø 6mm with collet

**34-MC15-06-06**

Coupling adapter with union nuts and 2 clamping nuts
nuts with M10 x 1mm thread for tube Ø6 x Ø6mm

**34-MO15-06-06**

Coupling adapter with union nuts and 2 clamping nuts
nuts with M10 x 1mm thread for tube Ø6 x Ø6mm
(complete with 2 sleeves)

**25-FPKM-04**

Hydraulic quick connector
"daddy" 1/4"

**25-FPKF-04**

Hydraulic quick connector
"mother" 1/4"



Banjo fittings for hydraulic and pneumatic connections



DL-CR20062

Kit (banjo fitting 12mm + M12 bolt + rubber-metal washers) for hose 8mm (zinc)



DL-CR20064

Kit (14mm banjo fitting, M14 bolt, rubber-metal washers) for hose 8mm (zinc)

Bolts with zinc coating:



22-HS-06 banjo bolt hydraulic M12x1.5mm

22-HS-08 Hydraulic banjo bolt M14x1.5mm

22-HS-10 Hydraulic banjo bolt M16x1.5mm

22-HS-13 Hydraulic banjo bolt M18x1.5mm

22-HZ-08 Banjo bolt hydraulic 1/4"

22-HZ-10 Banjo bolt hydraulic 3/8"

570RLP-08-08 Hydraulic banjo bolt 1/2"

Oxidized (black) coated bolt fittings:



DL-UNI30908 Fitting banjo-bolt M16x1.5mm

DL-UNI30364 Fitting banjo-bolt 1/4"

DL-UNI30363 Fitting banjo bolt 3/8"

DL-UNI30350 Fitting 1/2" banjo bolt

Banjo fittings with galvanized coating:



22-RSN-06 Banjo fitting Ø12mm herringbone 8mm

22-RSN-08-06 Banjo fitting Ø14mm herringbone 8mm

22-RSN-08 Banjo fitting Ø14mm herringbone 10mm

22-RSN-10 Banjo fitting Ø16mm herringbone 11-12mm

22-RSN-13 Banjo fitting Ø18mm herringbone 13-14mm

Adjusting washers for Common-Rail injectors BOSCH



DL08CR-220 Bosch

WASHER KIT
DFK type CRI ,CRIN
Ø= 3.5X5.3mm,
H=1.20-1.70mm, Pitch=0.02mm,
24 sizes x 10 = 240 pcs



DL08CR5-244 Bosch

WASHER KIT
DFK type CRI ,CRIN
Ø= 3.5X5.3mm,
H=1.20-1.70mm, Pitch=0.05mm,
11 sizes x 10 = 110 pcs



DL09CR-219 Bosch

WASHER KIT
Ø= 10.5 X 15.7 mm,
H=1.20-1.30mm, Pitch=0.01mm,
11 sizes x 10 = 110 pcs



DL10CR-235 Bosch

WASHER KIT
AHE type CRIN1
Ø= 19Es 22mm,
H=1.00-1.10mm, Pitch=0.01mm
11 sizes x 10 = 110 pcs



DL11CR-236 Bosch

WASHER KIT
RLS type CRI-1 CRI-2.0 CRI-2.2,
AHE type CRI-2.1
Ø= 19 X23.7mm,
H=1.00-1.10mm, Pitch=0.01mm
11 sizes x 10 = 110 pcs

Adjusting washers for Common-Rail injectors BOSCH



DL12CR-230 Bosch

WASHER KIT
VFK type CRI
Ø= 2.5X4.5mm,
H=1.20-1.70mm, Pitch=0.02mm
26 sizes x 10 = 260 pcs



DL12CR5-245 Bosch

WASHER KIT
VFK type CRI
Ø= 2.5X4.5mm,
H=1.20-1.70mm, Pitch=0.05mm
11 sizes x 10 = 110 pcs



DL14CR-228 Bosch

WASHER KIT
VFK type CRIN
Ø= 2.3X4.2mm,
H=1.20-1.70mm, Pitch=0.02mm
24 sizes x 10 = 240 pcs



DL14CR5-243 Bosch

WASHER KIT
VFK type CRIN
Ø= 2.3X4.2mm,
H=1.20-1.70mm, Pitch=0.05mm
11 sizes x 10 = 110 pcs



DL16CR-232 Bosch

WASHER KIT
DNH type CRI, CRIN
Ø= 2.25mm,
H=1.14-1.25mm, Pitch=0.01mm
12 sizes x 10 = 120 pcs

Adjusting washers for Common-Rail injectors BOSCH



DL17CR-269 Bosch

WASHER KIT
DFK type CRI ,CRIN
Ø= 3.5X5.3mm,
H=0.90-1.90mm, Pitch=0.05mm
21 size x 10 = 210 pcs



DL18CR-271 Bosch

WASHER KIT
CRI-1 CRI-2.0 CRI-2.2, AHE type CRI-2.1
Ø= 19 X23.7mm,
H=0.90-1.00mm, Pitch=0.01mm
11 sizes x 10 = 110 pcs



DL19CR-273 Bosch

WASHER KIT
RLS type CRIN-1
Ø= 19 Es 22mm,
H=0.90-1.00mm, Pitch=0.01mm
11 sizes x 10 = 110 pcs



DL24CR-301 Bosch

WASHER KIT
RLS type CRIN-1
Ø= 19Es 22mm,
H=1.30-1.40mm, Pitch=0.01mm
11 sizes x 10 = 110 pcs



DL25CR-288 Bosch

WASHER KIT
AHE type CRIN1
Ø= 18 Es 22mm,
H=1.00-1.10mm, Pitch=0.01mm
11 sizes x 10 = 110 pcs

Adjusting washers for Common-Rail injectors BOSCH



DL26CR-283 Bosch

WASHER KIT
DNH type CRI,CRIN
Ø= 2.3 mm,
H=0.95-1.13mm, Pitch=0.01mm
19 sizes x 10 = 190 pcs



DL28CR-287 Bosch

WASHER KIT
AHE,RLS type CRIN2, CRIN3
Ø= 19.5 X 22.8mm,
H=1.34-1.76mm, Pitch=0.02mm
22 sizes x 10 = 220 pcs



DL180CR-180 Bosch

WASHER KIT
Ø= 19 Es22 mm,
H=1.20-1.30mm,
Pitch = 0.01mm
11 sizes x 10 = 110 pcs



DL77CR-77 Bosch

WASHER KIT
DFK type CRI ,CRIN
Ø= 3.5x 5.3mm,
H=1.04-1.44mm, Pitch=0.02mm
21 size x 10 = 210 pcs



DL376CR-376 Bosch

WASHER KIT
RLS type CRI ,CRIN
Ø= 2.5x 6.4mm,
H=1.00-1.20mm, Pitch=0.01mm
21 size x 10 = 210 pcs

Adjusting washers for Common-Rail injectors BOSCH

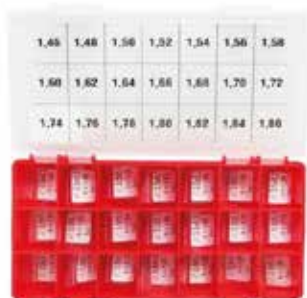

DL88CR-88 Bosch

WASHER KIT
DFK type CRI, CRIN
Ø= 3.5x 5.3mm,
H=1.46-1.86mm, Pitch=0.02mm
21 size x 10 = 210 pcs



DL99CR-99 Bosch

WASHER KIT
AHE type CRI-1, CRI2.0, CRI2.2
Ø= 10.5 x 15.7mm,
H=1.12-1.23mm, Pitch=0.01mm
12 sizes x 10 = 120 pcs



DL120CR-120 Bosch

WASHER KIT
VFK CRIN
Ø= 2.5 x 4.5 mm,
H=1.70-1.90mm, Pitch=0.02mm
11 sizes x 10 = 110 pcs



DL20CR-272 Bosch

WASHER KIT
VFK CRI
Ø= 2.40 x 5.30mm,
H=1.72-1.90mm, Pitch=0.02mm
10 sizes x 10 = 100 pcs



DL377CR-377 Bosch

WASHER KIT
RLS type CRI, CRIN
Ø= 2.5x 6.4mm,
H=1.21-1.40mm, Pitch=0.01mm
20 size x 10 = 200 pcs

Adjusting washers for Common-Rail injectors BOSCH



DL22CR-222 Bosch

WASHER KIT

Ø= 4.4x 7.7mm,
H=0.98-1.44mm, Pitch=0.02mm
24 size x 10 = 240 pcs

Adjusting washers for CR DENSO injectors



DL130CR-130 Denso

WASHER KIT

DENSO VFK
Ø= 3.0 x 5.75mm,
H=1.10-2.00mm, Pitch=0.05mm
19 sizes x 10 = 190 pcs



DL78CR-78 Denso

WASHER KIT

DENSO VFK
Ø= 3.0 x 6.75mm
H=1.75-2.30mm, Pitch=0.05mm
12 sizes x 10 = 120 pcs



DL55CR-344 Denso

WASHER KIT

DENSO VFK
Ø= 24.3 mm x21.5 mm,
H=1.50-1.72mm, Pitch=0.01mm
23 size x 10 = 230 pcs



DL57CR-843 Denso

WASHER KIT

DENSO VFK
Ø= 4mm x1.8mm,
H=1.00-2.00mm, Pitch=0.05mm
21 size x 10 = 210 pcs

Adjusting washers for CR DENSO injectors



DL70CR-DENSO

WASHER KIT
 $\varnothing = 23 \times 21$ mm,
 $H = 3.00-3.10$ mm,
 Pitch = 0.01 mm,
 11 sizes x 10 = 110 pcs

Adjusting washers for Common-Rail VDO (SIEMENS) PIEZO injectors



DL-400CR-VDO

**ADJUSTING SET
 WASHER VDO (SIEMENS)**
 \varnothing ext. = 18 mm,
 \varnothing inside = 14 mm,
 $H = 0.9-1.13$ mm,
 Pitch = 0.01 mm
 24 sizes x 10 = 240 pcs.
 or 24 x 5 = 120 pcs



DL-410CR-VDO

**ADJUSTING SET
 WASHER VDO (SIEMENS)**
 \varnothing ext. = 5.7 mm,
 \varnothing inside = 3 mm,
 $H = 1.00-2.00$ mm,
 Pitch = 0.05 mm
 24 sizes x 10 = 240 pcs.
 or 24 x 5 = 120 pcs

Adjusting washers and adjusting elements for CR DELPHI injectors



DL-378CR-SMART E3

ADJUSTING SET WASHER DELPHI SMART E3

Ø ext. = 4.3 mm,
Ø inside = 1.9 mm,
H = 1.15-1.70 mm,
Pitch = 0.05mm
12 sizes x 10 = 120 pcs.
or 12 sizes x 5 = 60 pcs



DL-600CR-DELPHI

SET OF ADJUSTING ELEMENTS

Ø = 2.0 mm,
H = 2.30-2.64mm,
Pitch = 0.02mm
18 sizes x 10 = 180 pcs.



DL-601CR-DELPHI

SET OF ADJUSTING ELEMENTS

Ø = 2.00 mm,
H = 2.66-3.00 mm,
Pitch = 0.02mm
18 sizes x 10 = 180 pcs



DL-602CR-DELPHI

SET OF ADJUSTING ELEMENTS

Ø = 2.0 mm,
H = 3.75-4.30mm,
Pitch = 0.05mm
11 sizes x 10 = 110 pcs.

Adjusting washers and adjusting elements for CR DELPHI injectors



DL-603CR-DELPHI

SET OF ADJUSTING ELEMENTS

Ø = 2.00 mm,
H=4.35-4.90mm,
Pitch = 0.05mm
12 sizes x 10 = 110 pcs

Adjusting washers for Unit Injectors (UIS) and Single Pumps (PLD)



DL-723UIS

ADJUSTING SET WASHER FOR UIS/UIP

Ø outside= 7.3 mm, Ø inside= 3.0 mm,
H=0.30-0.58mm, Pitch=0.02mm
15 sizes X 10 = 150 pcs.
or 15 sizes x 5 = 75 pcs



DL-724UIS

ADJUSTING SET WASHER FOR UIS/UIP

Ø outside= 7.3 mm, Ø inside= 3.0 mm,
H=0.50-1.05mm, Pitch=0.05mm
12 sizes x 10 = 120 pcs.
or 12 sizes x 5 = 60 pcs



DL-725UIS

ADJUSTING SET WASHER FOR UIS/UIP

Ø outside= 9.3 mm, Ø inside= 4.7 mm,
H=0.40-0.80mm, Pitch=0.02mm
21 sizes x 10 = 210 pcs.
or 21 sizes x 5 = 105 pcs

Adjusting washers for Unit Injectors (UIS) and Single Pumps (PLD)



DL-726UIS

ADJUSTING SET WASHER FOR UIS/UIP

Ø outside= 8.3 mm, Ø inside= 4.7 mm,
H=0.40-0.80mm, Pitch=0.02mm
21 sizes x 10 = 210 pcs.
or 21 sizes x 5 = 105 pcs



DL-727UIS

ADJUSTING SET WASHER FOR UIS/UIP

Ø outside= 5.0 mm, Ø inside= 2.5 mm,
H =0.50-1.00 mm, Pitch = 0.02 mm 337
26 sizes x 10 = 260 pcs.
or 26 sizes x 5 = 130 pcs



DL-728UIS

ADJUSTING SET WASHER FOR UIS/UIP

Ø outside= 5.0 mm, Ø inside= 2.5 mm,
H=0.50-1.05mm, Pitch=0.05mm
12 sizes x 10 = 150 pcs.
or 12 sizes x 5 = 60 pcs



DL-729UIS

ADJUSTING SET WASHER FOR UIS/UIP

Ø outside= 4.3 mm, Ø inside= 1.9 mm,
H=0.50-1.10mm, Pitch=0.05mm
12 sizes x 10 = 120 pcs.
or 12 sizes x 5 = 60 pcs

Adjusting washers for Unit Injectors (UIS) and Single Pumps (PLD)



DL-730UIS

ADJUSTING SET WASHER FOR UIS/UIP

Ø outside= 4.3 mm, Ø inside= 1.9 mm,
H=1.10-1.50mm, Pitch=0.05mm
9 sizes x 10 = 90 pcs.
or 9 sizes x 5 = 45 pcs



DL-731UIS

ADJUSTING SET WASHER FOR UIS/UIP

Ø outside= 4.3 mm, Ø inside= 1.9 mm,
H=1.15-1.70mm, Pitch=0.05mm
12 sizes x 10 = 120 pcs.
or 12 sizes x 5 = 60 pcs

Tools and fixtures for grinding washers and other parts

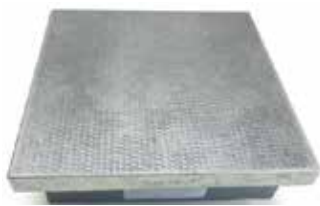

D-261102

Plate (finishing)
lapping
Size: 200x200 mm

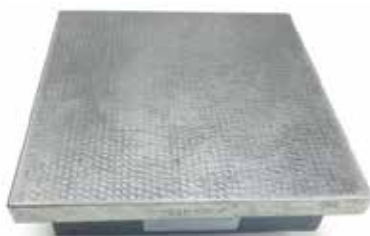

D-190171108

Plate (finishing)
lapping
Size: 300x300 mm

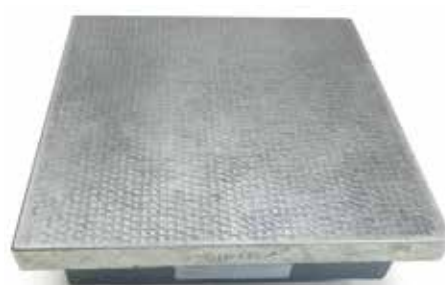

D-190171207

Plate (finishing)
lapping
Size: 400x400 mm



DL-UNI50270

Set of washer holders for grinding them. The kit includes two holders with diameters for different pucks. It is recommended to carry out grinding on a special lapping plate.



DL-UNI31635

Holder for lapping spacers and nozzle valves Piezo Bosch



DL-TS800PL

Tachometer board



DL-PTC700PL

PTC device board



DL-FMDE800PL

Flow meter board FMDE



DL-CR500PL

Cristina instrument board



DL-CRP600PL

Cristina-Piezo instrument board



DL-AC400PL

Board from the Acoustic kit



DL-CAS1200PL

CASCADE board



DL-CASP400PL

Piezo board CASCADE



DL-RPC160PL

Time circuit board
injector response



DL-SHT180PL

Printed circuit board
curtain control
measuring block



With our full range of products
You can find it on the website:
www.dieselland.eu

CONTACTS:

DIESELLAND - GENERAL OFFICE

Dieselland OÜ | Tehnopargi tee 11, Tõrvandi 61715, Kambja vald, Estonia

Phone.: +372 505 2207

E-mail.: export@dieselland.eu, info@dieselland.eu